

# IARPB® CONNECTOR HOUSING

## Packing Standard





6	RS0831	Apr. 15/'21	T.Hoshino	M.Muta	E.Kawabe
5	RS0738	Oct. 22/'20	T.Hoshino	M.Muta	J.Tateishi
4	RS0608	June 21/'19	Y.Takagi	J.Tateishi	E.Kawabe
3	RS0479	June 14/'18	Y.Takagi	E.Kawabe	E.Kawabe
Rev.	ECN	Date	Prepared by	Checked by	Approved by

## 1. Product name(s) and part number(s)

IARPB CONNECTOR HOUSING

Poles	Part number	Color
2P	V0039-91002-2Z1	Natural
3P	V0039-91003-2Z1	Natural
4P	V0039-91004-2Z1	Natural
5P	V0039-91005-2Z1	Natural
6P	V0039-91006-2Z1	Natural

## 2. Packing material and quantity

Poles	Part number	Packing bag		Packing carton		Pieces per packing bag [pcs]	Quantity per packing carton	
		Outer dimension		Outer dimension	P/N		[pcs]	
		(W×D) [mm]		(W×D×H) [mm]				
2P	V0039-91002-2Z1	165 x 270		206 x 306 x 214	V0094-P1001-001	1,000	1,000 × 10bags = 1,0000	
3P	V0039-91003-2Z1	165 x 270		206 x 306 x 214	V0094-P1001-001	1,000	1,000 × 10bags = 1,0000	
4P	V0039-91004-2Z1	165 x 270		206 x 306 x 214	V0094-P1001-001	1,000	1,000 × 10bags = 1,0000	
5P	V0039-91005-2Z1	200 x 340		306 x 406 x 214	V0094-P1001-002	1,000	1,000 × 10bags = 1,0000	
6P	V0039-91006-2Z1	200 x 340		306 x 406 x 214	V0094-P1001-002	1,000	1,000 × 10bags = 10,000	

## 3. Label

P/N	①	PC	CHECK	⑧
Q' TY	②		⑥	
LOT	③			
⑤	NAME :		REMARK	
	④	RoHS Compliant		
	MADE IN *****←	I-PEX		
		⑦		

- ① Part number
- ② Quantity
- ③ Product lot number

Y	Y	M	M	D	D	#	#	#	#
Year		Month		Day		Note 1			

Note 1: Code for plant usage.

- ④ Product name (addr.)
- ⑤ QR code
- ⑥ Check stamp
- ⑦ Country of origin
- ⑧ Recycle mark and compliance mark

4. Packing Method

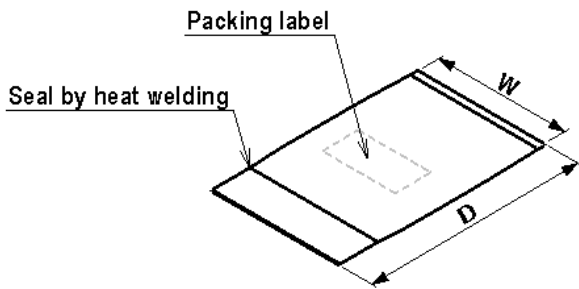
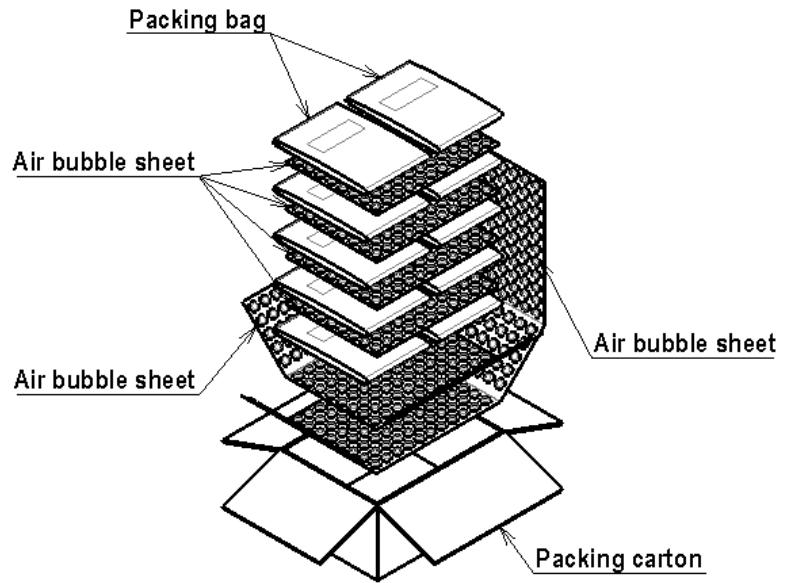
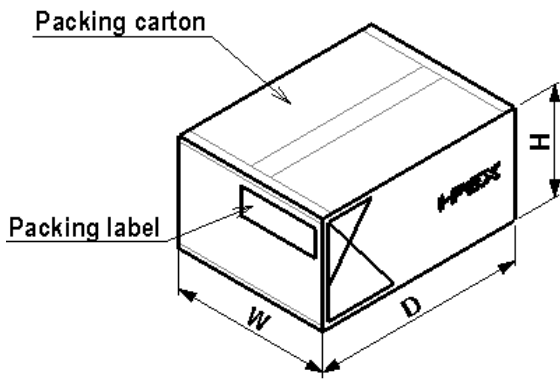

Fig1. Packing Bag



6 Fig.2. Type of packing



6 Fig.3. Packing Carton