

EVAFLEX® 5-SE-GHT

Part No. 20899-0**E-01

Packing Standard

0	S19214	March 26, 2019	M.Nakamura	T.Kurachi	H.Ikari
Rev.	ECN	Date	Prepared by	Checked by	Approved by

EVAFLEX 5-SE-GHT Packing Standard

1. 製品名称 (NAME) & 製品番号 (ITEM Part No.)

EVAFLEX 5-SE-GHT : 20899-0**E-01







2. 梱包材料 (PACKING MATERIAL)

芯数 (Pos.)	インボステープ° (EMBOSS TAPE) P/N 950571-0**		リール (REEL) P/N 950305		外装カートン (PACKING CARTON) P/N 950000
	テープ幅 (TAPE WIDTH)	厚み (THICKNESS)	リール径 (DIAMETER)	テープ幅 (TAPE WIDTH)	
20P	32.0	6.8	Φ380	37.4	406×406×214 OUTER
30P	44.0			49.4	
40P					
50P					
60P	56.0			61.4	

3. 梱包数量 (PACKING QTY.)

芯数 (Pos.)	インボステープ° 入数(リール 1 本あたり) QTY. IN EMBOSS TAPE (1 REEL)	外装カートン入数(1 箱あたり) QTY. IN PACKING CARTON (1 CARTON)
20P	1500	1500 × 4 = 6000 (4 リール(REELS))
30P		1500 × 3 = 4500 (3 リール(REELS))
40P		1500 × 3 = 4500 (3 リール(REELS))
50P		1500 × 3 = 4500 (3 リール(REELS))
60P		1500 × 3 = 4500 (3 リール(REELS))

4. 現品票 (LABEL)

20090909011300-00001			
P/N	①	CHECK	捆包卷盘
Q'TY	②	⑦	 06 PS
LOT	③		料带封带
	NAME: ④	REMARK	 01 PET
	MADE IN <input type="text"/> ⑤	 	捆包料带
DAI-ICHI SEIKO CO.,LTD.			 06 PS
			

①... Part number : Ex. 20899-020E-01

②... QTY.

③... Products lot No. :

It is constituted from ten figures. (See below.)

NN NN NN NNNN

A B C D

A : Last two figures of the Christian era (two figures)

B : Month (two figures)

C : Day (two figures)

D : It is cord number that I-PEX uses. (four figures)

Example : 170820H010

It means that the Product was manufactured on Aug./20/2017

④... Item : Ex. EVAFLEX 5-SE-GHT 20P

⑤... Production country

⑥... QR code

⑦... Check stamp

5. 外装カートンへの梱包[図 1 参照] (PACKING OF P CARTON [See Fig.1.])

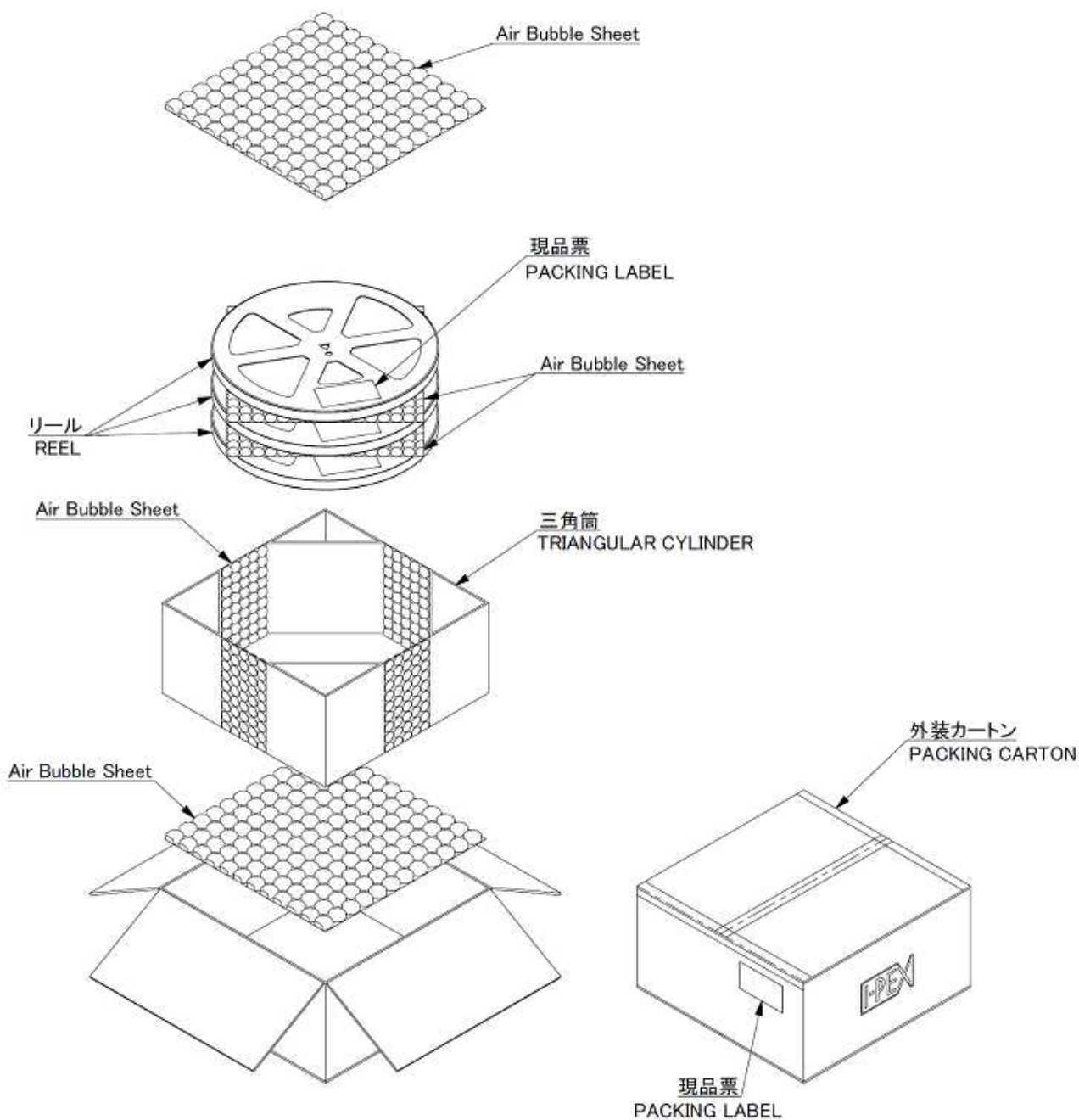

図 1 (Fig.1)