

EVAFLEX® 5-HD

Part No. 20952-0**E-02

Packing Standard

Rev.	ECN	Date	Prepared by	Checked by	Approved by
1	S20008	January 9, 2020	H.Kaneko	M.Muro	H.Ikari
0	S19241	April 15, 2019	H.Kaneko	M.Muro	Y.Shimada

EVAFLEX 5-HD Packing Standard

1. 製品名称 (NAME) & 製品番号 (ITEM Part No.)

EVAFLEX 5-HD : 20952-0**E-02







2. 梱包材料 (PACKING MATERIAL)

芯数 (Pos.)	インボステープ° (EMBOSS TAPE) P/N 950597		リール (REEL) P/N 950305		外装カートン (PACKING CARTON) P/N 950000
	テープ幅 (TAPE WIDTH)	厚み (THICKNESS)	リール径 (DIAMETER)	リール幅 (REEL WIDTH)	
24	32.0	2.95	Φ380	37.4	406×406×214 OUTER

3. 梱包数量 (PACKING QTY.)

芯数 (Pos.)	インボステープ° 入数(リール 1 本あたり) QTY. IN EMBOSS TAPE (1 REEL)	外装カートン入数(1 箱あたり) QTY. IN PACKING CARTON (1 CARTON)
24	2500	2500 × 4 = 10000 (4 リール(REELS))

4. 現品票 (LABEL)

20090909011300-00001			
P/N	①	CHECK	捆包卷盘 ⑦ 06 PS 料带封带
Q'TY	②	⑦	
LOT	③		
	NAME: ④	REMARK	 01 PET 捆包料带  06 PS 
	MADE IN <input type="text"/> ⑤  		
DAI-ICHI SEIKO CO.,LTD.			

①... Part number : Ex. 20952-024E-02

②... QTY.

③... Products lot No. :

It is constituted from ten figures. (See below.)

NN NN NN NNNN

A B C D

A : Last two figures of the Christian era (two figures)

B : Month (two figures)

C : Day (two figures)

D : It is cord number that I-PEX uses. (four figures)

Example : 170820H010

It means that the Product was manufactured on Aug./20/2017

④... Item : Ex. EVAFLEX 5-HD 24P

⑤... Production country

⑥... QR code

⑦... Check stamp

5. 外装カートンへの梱包[図 1 参照] (PACKING OF P CARTON [See Fig.1.])

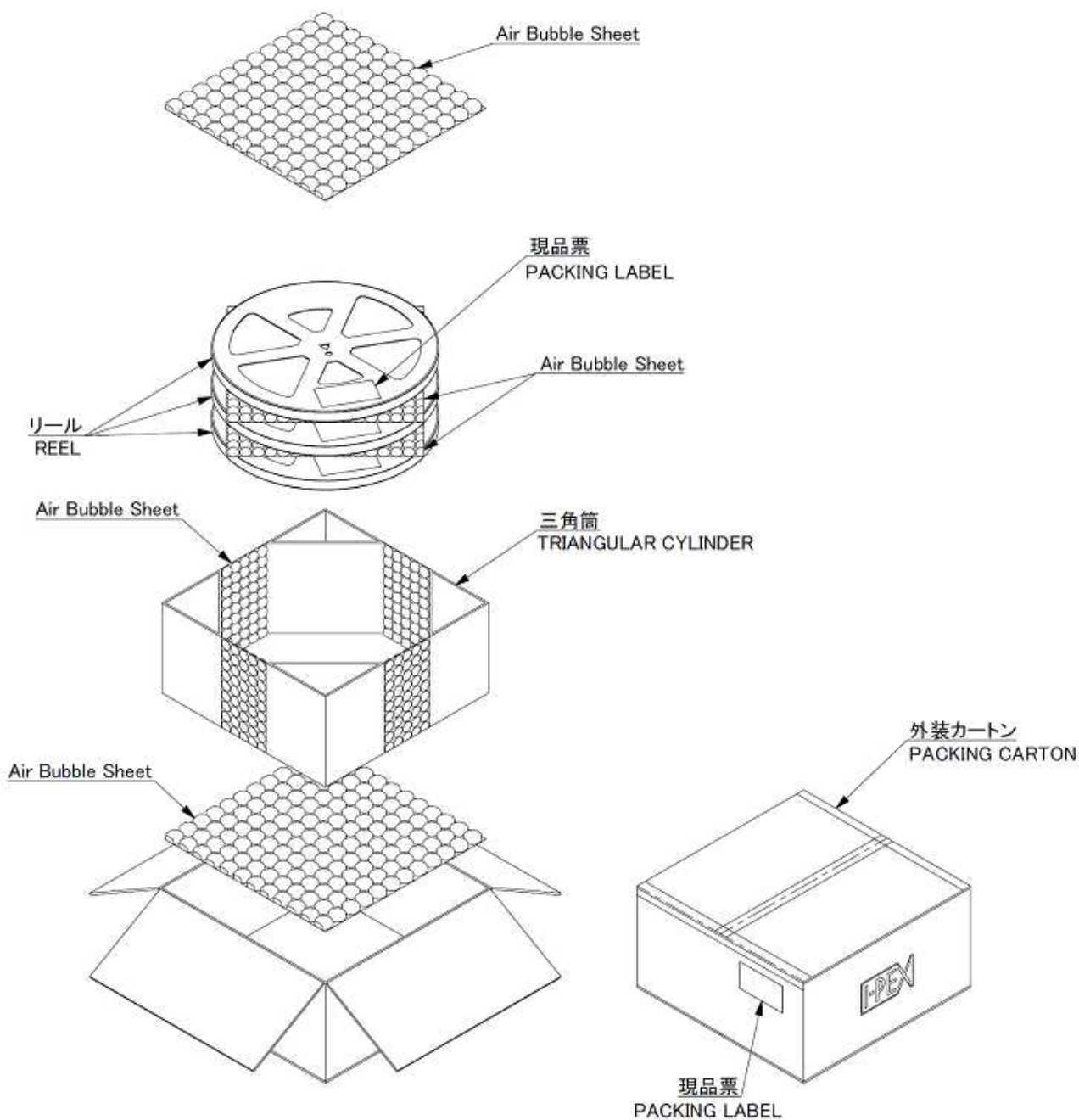

図 1 (Fig.1)