

# CABLINE®-CX II Lock Bar Ass'y

Part No. 20975-040T-01

## Packing Standard

1	S19511	September 4, 2019	S.Yamaguchi	T.Kurachi	H.Ikari
0	S17744	October 6, 2017	R.Hoshino	T.Yayoshi	M.Takemoto
Rev.	ECN	Date	Prepared by	Checked by	Approved by

# CABLINE-CX II Lock Bar Ass'y Packing Standard

1. Product Name : CABLINE-CX II Lock Bar Ass'y  
 Parts No. : 20975-040T-01

## 2. PACKING MATERIAL



TRAY P/N 950268				SHIPPING CARTON P/N 950001	PACKING CARTON P/N 950000
MEASURE	POCKET WIDTH Fig.2	DEPTH	POCKET QUANTITY		
360 × 165	29.0 × 8.0	3.5	100 (TOTAL)	385 × 175 × 90 OUTER	406 × 406 × 214 OUTER

PLASTIC BAG P/N 950524	DESICCANT
SIZE	QUANTITY (1 BAG)
460 × 305	3 g × 1



## 3. PACKING QUANTITY

QUANTITY IN DITCH	QUANTITY IN TRAY	QUANTITY IN SHIPPING CARTON (TRAY QUANTITY)	QUANTITY IN PACKING CARTON (SHIPPING CARTON QUANTITY)
1	100	2,000 (20 TRAYS)	8,000 (4 BOXES)

### 4. LABEL

20090909011300-00001		
P/N	①	CHECK
Q'TY	②	⑦
LOT	③	
	NAME: ④	REMARK
	MADE IN <input type="text"/> ⑤  	
DAI-ICHI SEIKO CO.,LTD.		

托盘

... Part number : Ex. 20975-040T-01

... Quantity

... Products lot No. :

It consists of from ten figures.(See below.)

Y Y M M D D N N N N  
A B C D

A : Year (two figures)

B : Month (two figures)

C : Day (two figures)

D : It is code No. that DAI-ICHI SEIKO uses. (four figures)

Example : 170314J010

It means that the Product was manufactured on Mar./14/2017

... Item : Ex. CABLINE-CX II LOCK BAR ASS'Y

... Production country

... QR code

... Check stamp

Direction of products putting in tray

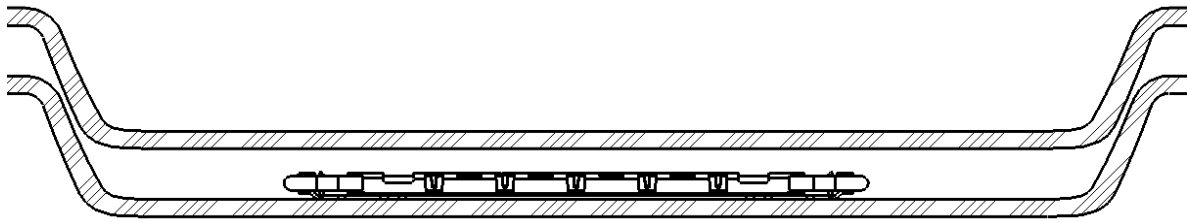

Fig. 1

[ NOTE ] Piling the tray to the same direction and putting a lid on the tray with empty tray.

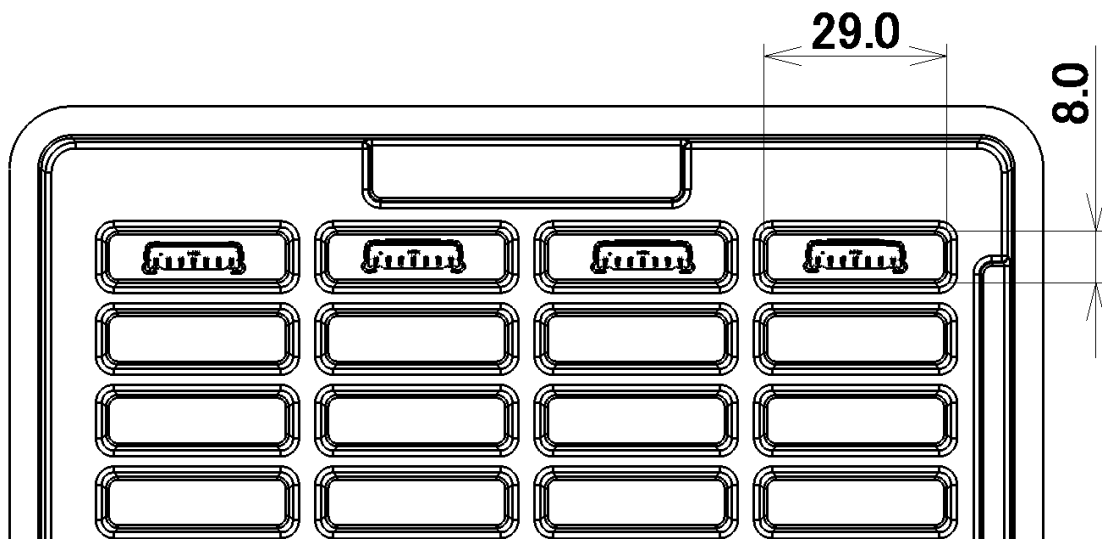
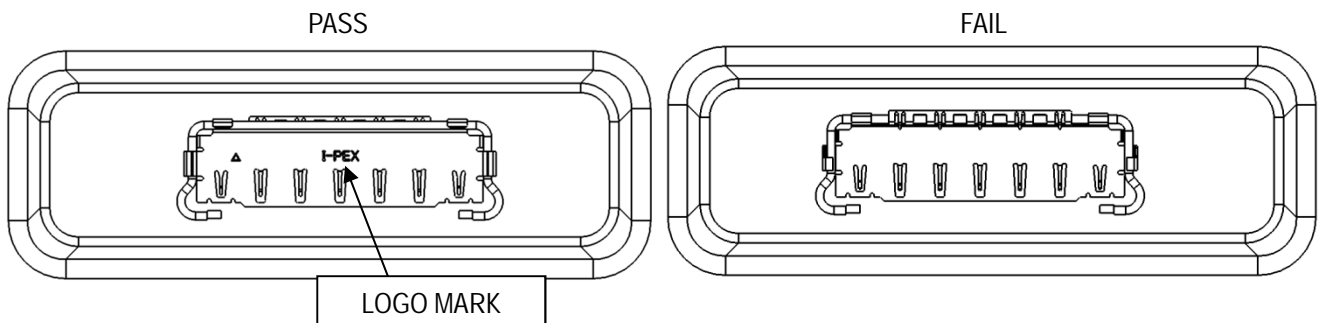

Fig. 2

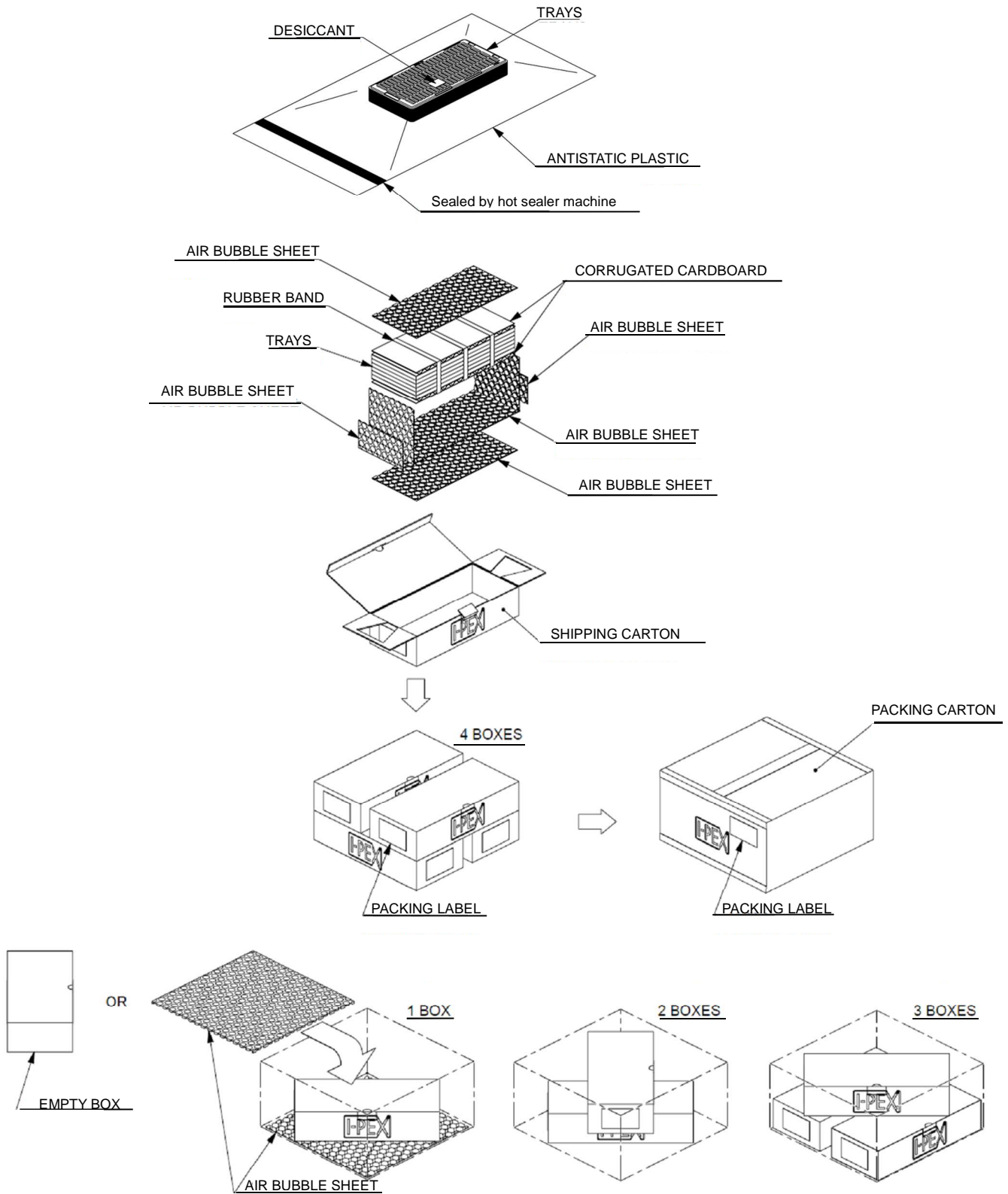

Fig.3

\*If operator pulls up the rubber band when they take out parts, there is possibility that tray bundle loosen and the parts drop out.  
Please note the taking up method.

