

NOVASTACK® 35-HDN

Part No. PLUG:20864-0**E-01 RECEPTACLE:20865-0**E-0#

Instruction Manual

5	S23301	September 7, 2023	W. Lau	Y. Baba	Y. Hashimoto
4	S23201	June 23, 2023	Y. Kawano	Y. Baba	Y. Hashimoto
3	S22551	May 26, 2023	W. Lau	Y. Shimizu	M. Takemoto
2	S19630	December 12, 2019	R. Shioya	T. Yayoshi	Y. Shimada
Rev.	ECN	Date	Prepared by	Checked by	Approved by

This manual provides the insertion & withdrawal methods and cautions to handle NOVASTACK 35-HDN connector properly.

1.Connector Name, Part number, Part name

1-1. Plug connector

Product Name : NOVASTACK 35-HDN Plug Ass'y

Part No. : 20864-0**E-01

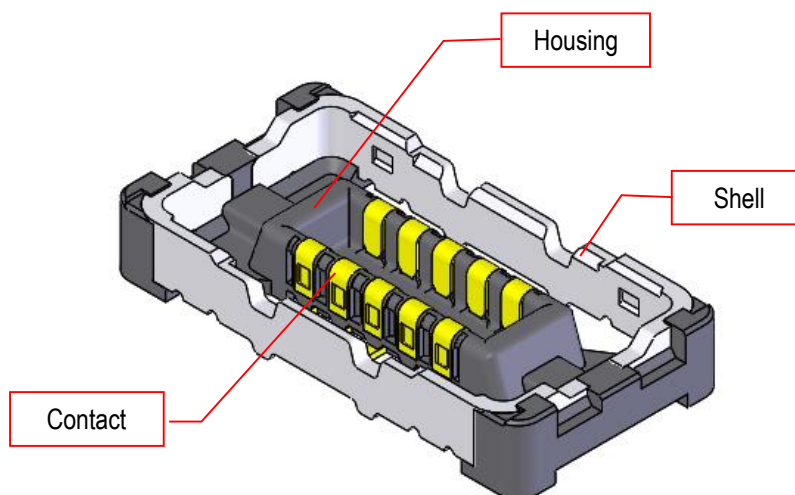

1-2. Receptacle connector

Product Name : NOVASTACK 35-HDN Receptacle Ass'y

Part No. : 20865-0**E-0#

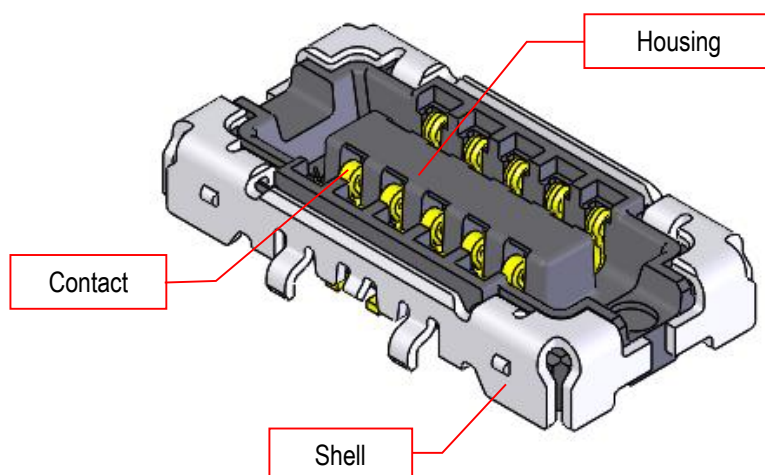

“ ** ” part shows the number of the connector position.

1-3. Connectors Mating Direction

The plug and the receptacle can be mated in both ways.

The performance of the connector will not be affected by the mating direction of the connectors.

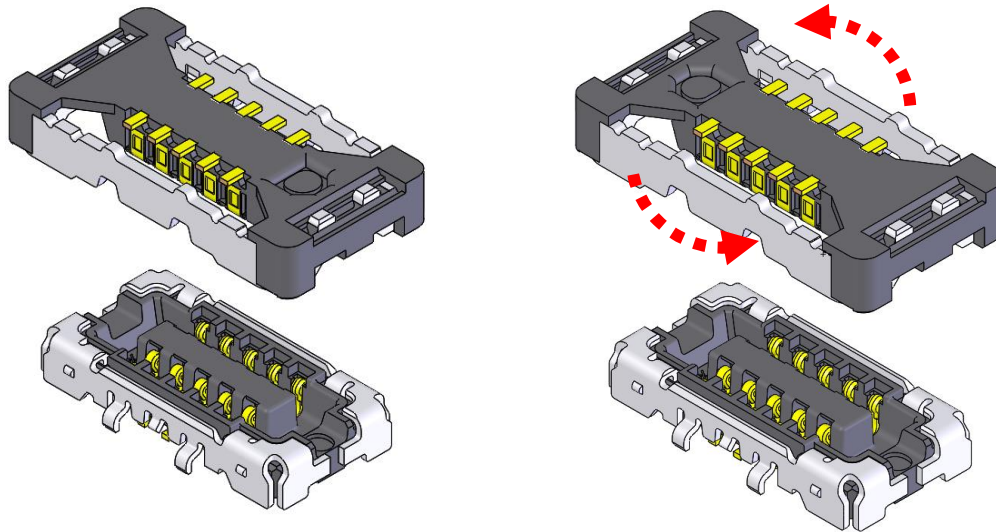

2. Mounting

2-1 The recommended pattern dimensions are shown in the product drawing.

2-2 The recommended metal mask thickness and opening area ratio.

Refer to the drawing 20864 (plug) and 20865 (receptacle).

2-3. Warp of PCB or FPC

Please keep the warp of PCB or FPC on 0.02 mm or less for the overall length of the connector.

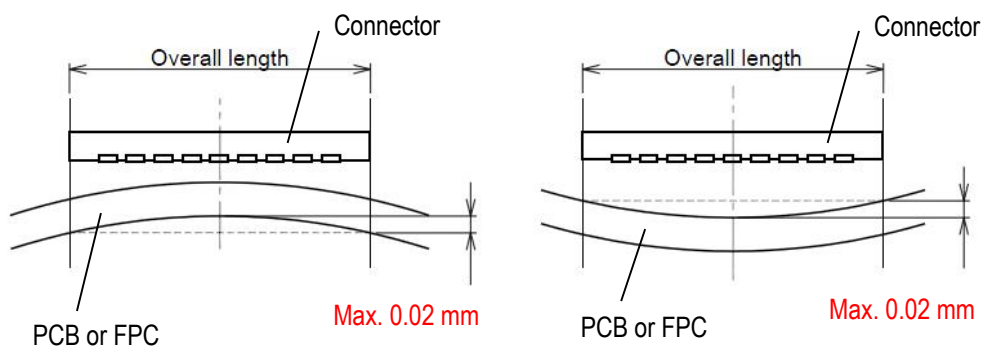

2-4 Reflow Temperature Profile

The peak reflow temperature profile is shown in Graph 1. (The temperature mentioned refers to the surface temperature of the printed circuit board near the connector terminal.)

Please refer to our product drawings for the recommended reflow temperature profile.

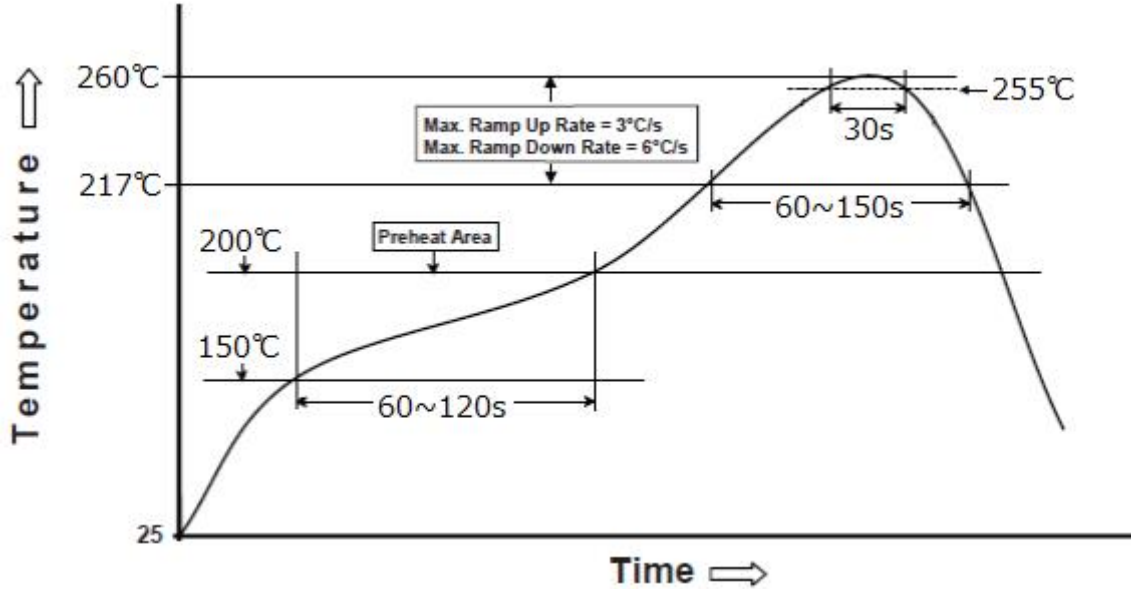

Graph 1 The Peak Reflow Temperature Profile

2-5 Hand Soldering

Do not apply flux when soldering by hands. The flux might rise inside the connector or it may scatter.

The tip of the soldering iron must not touch the connector while soldering.

A tip of the soldering iron shall touch the footprint pattern to prevent the connector from melting or deforming.

Soldering iron tip temperature must be at 350°C / 3 seconds when soldering.

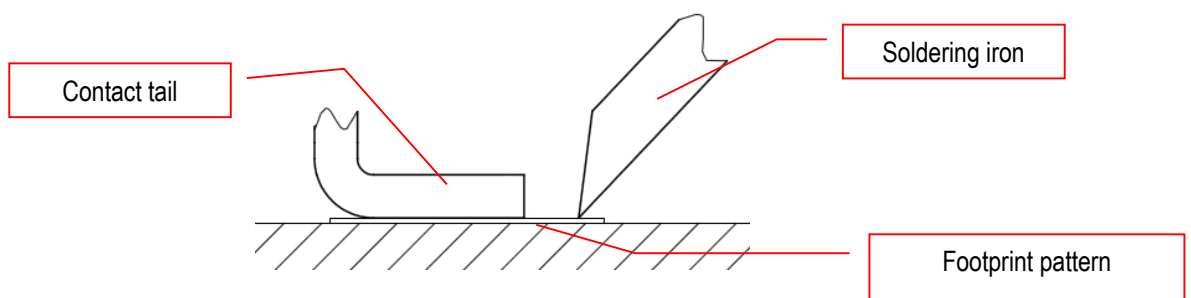

3. Cautions for Handling the Component

3-1. Using for board to FPC connection.

① FPC shall not be tensed to withstand in case of a shock or a tension is applied.

The FPC shall be fixed toward the mating direction for the maintenance.

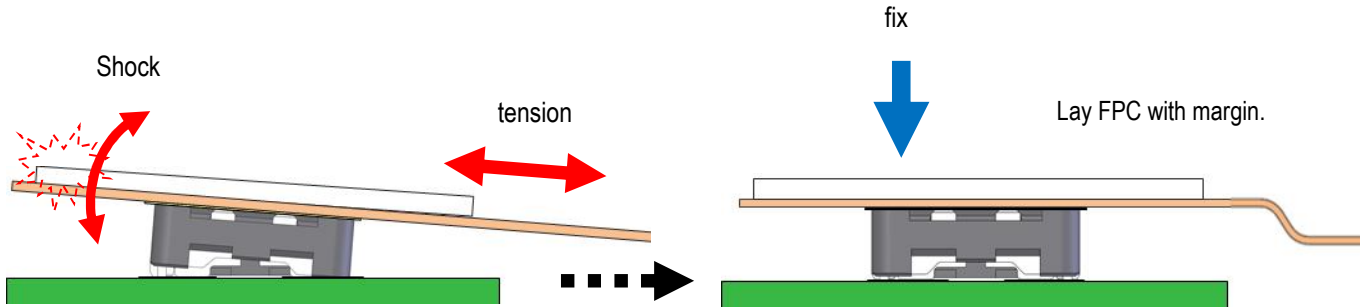

② FPC shall be used with the stiffener to prevent the connector on the FPC side from the breakage during insertion and extraction.

Recommended stiffener size: Larger than the connector external shape including footprint pattern.

Recommended thickness of the FPC and a stiffener: Thicker than 0.3 mm or more.

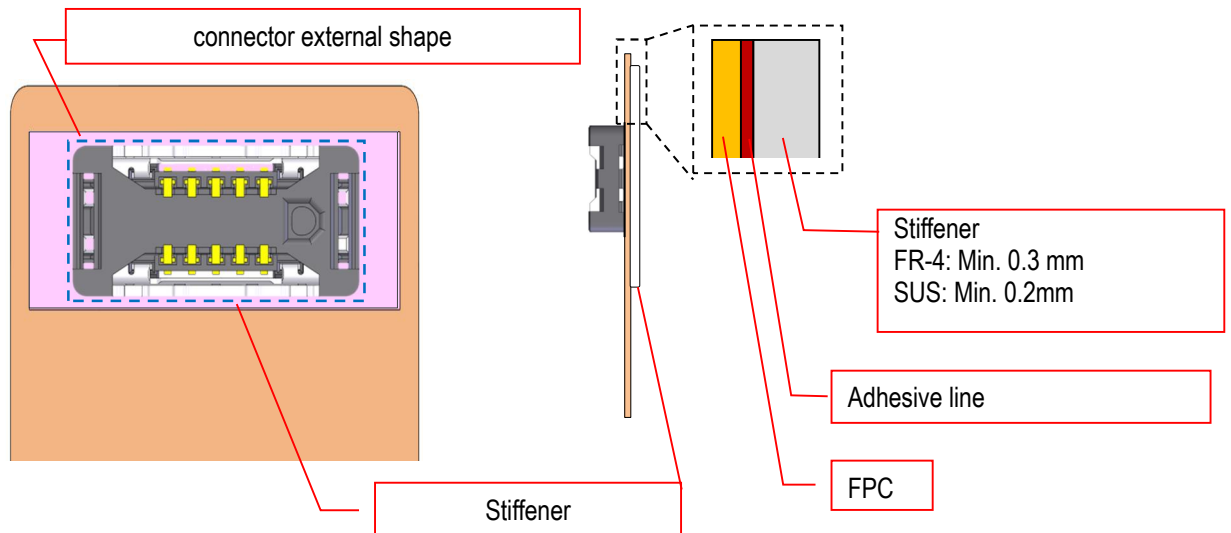

3-2. Using for board-to-board connection.

- ① To prevent the accidental removal or slant mating, spacers are recommended to fix the space in between the two printed circuit board. There spacers will also help to prevent the damage to the connectors and to the soldered area which might have been caused by the too large printed circuit board or unbalanced shape printed circuit board.

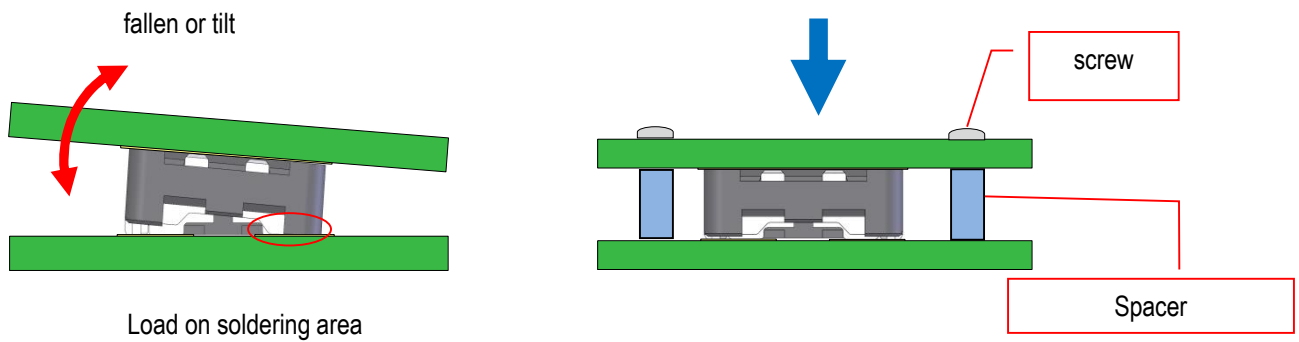

- ② Do not turn around the connector on the printed circuit board in case of using a screw.

If the printed circuit boards were fixed in a wrong position, the connectors may get damaged.

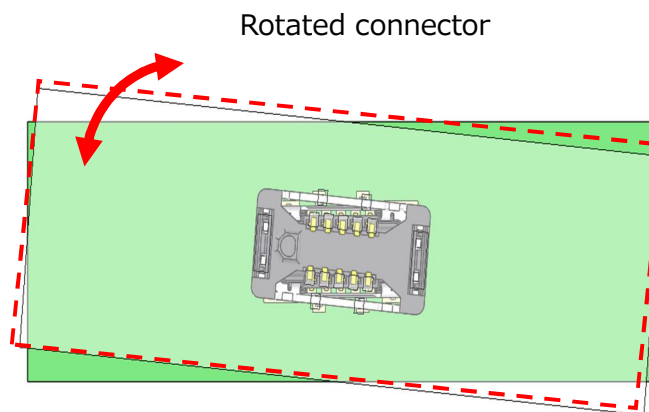

3-3. Press load

To prevent the coming off of the mated connectors (the load which a connector can apply), press the entire upper surface of the connector with the load calculated in below formula.

(Maximum Press load : number of pin×1.0N or under)

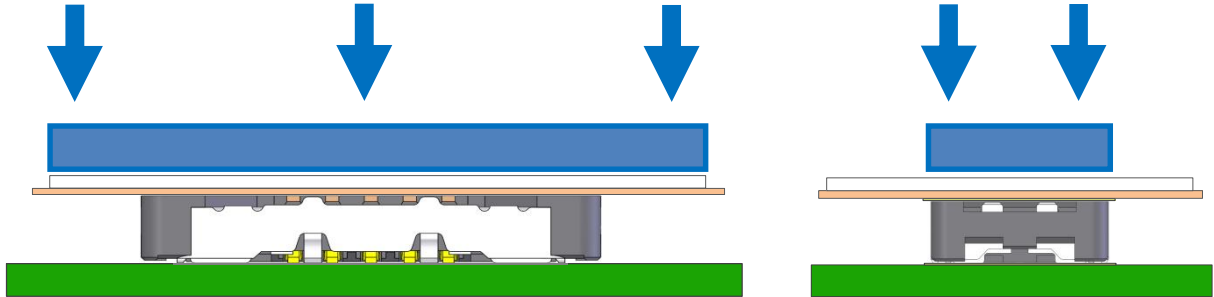

4. Mating and Unmating

4 -1. Always mate and unmate the connectors horizontally. An excessive twisting or slanting when mating and unmating will damage the connectors.

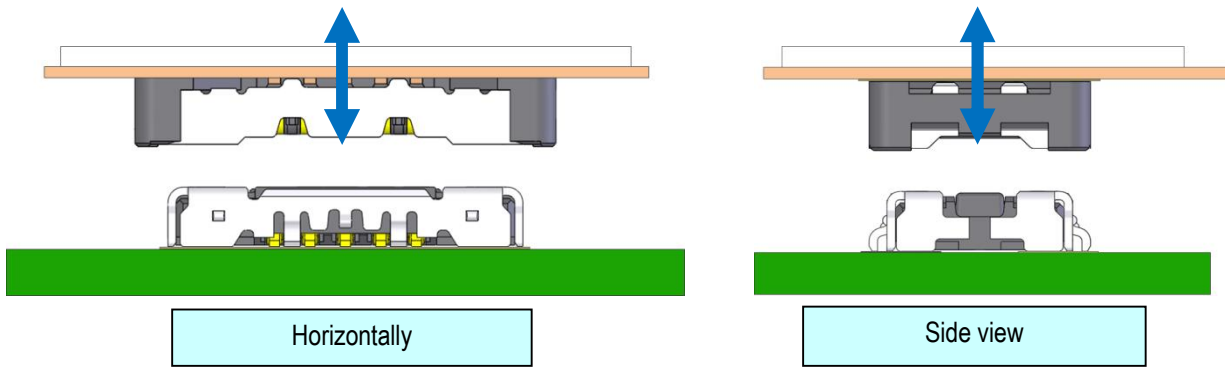

4-2. Cautions

[Caution 1]

Insertion angle shall not be slanted more than 10 degrees.
Slanted degree over 10 degrees may cause the deformation of the connector.

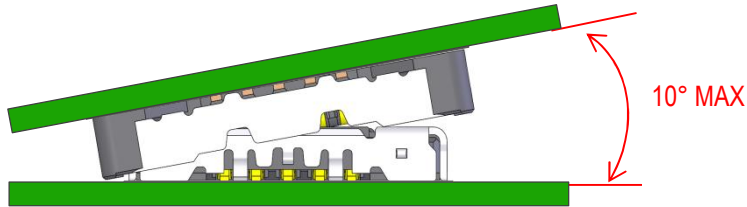

[Caution 2]

At starting the insertion, please keep the slant 10 ° or less in direction of depth.
By inserting with the slant more than 10°, deformation of the connector will occur.

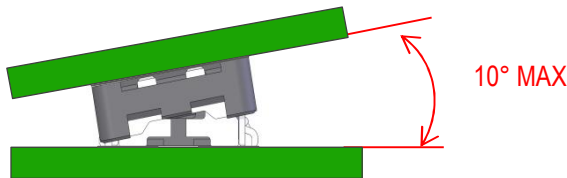

[Caution 3]

Pressing straight from upper side, the posture becomes stable by guide function of connector.
Do not insert forcibly from oblique direction.



[Caution 4]

Do not mate or unmate when the connector is turned around.

