

CABLINE®-CA II PLUS

Part No. PLUG:20788-0**T-0#, Receptacle : 20790-0**E-0##

Instruction Manual

2	S21143	April 28, 2021	R.Hatano	T.Tanigawa	H.Ikari
1	S18531	August 27, 2017	M.Nakamura	T.Kurachi	Y.Shimada
0	S17276	Apr./12'17	T.Masunaga		H.Ikari
Rev.	ECN	Date	Prepared by	Checked by	Approved by

This manual provides the insertion & withdrawal methods and cautions to handle CABLINE-CA II connector properly.

【Connector Name, Part number】

◆ The cable side connector

Product Name : CABLINE-CA II PLUS Plug

Part No. : 20788-0**T-0#

1 : Without Pull Tape

2 : With Pull Tape

◆ The PCB side connector

Product Name : CABLINE-CA II PLUS Receptacle

Part No. : 20790-0**E-0##

1 : With Boss

2 : Without Boss

“ ** ” part shows the number of the connector position.

“ # ” part shows the variation. Please refer to the drawing for details.

【Names of each part of the connector.】

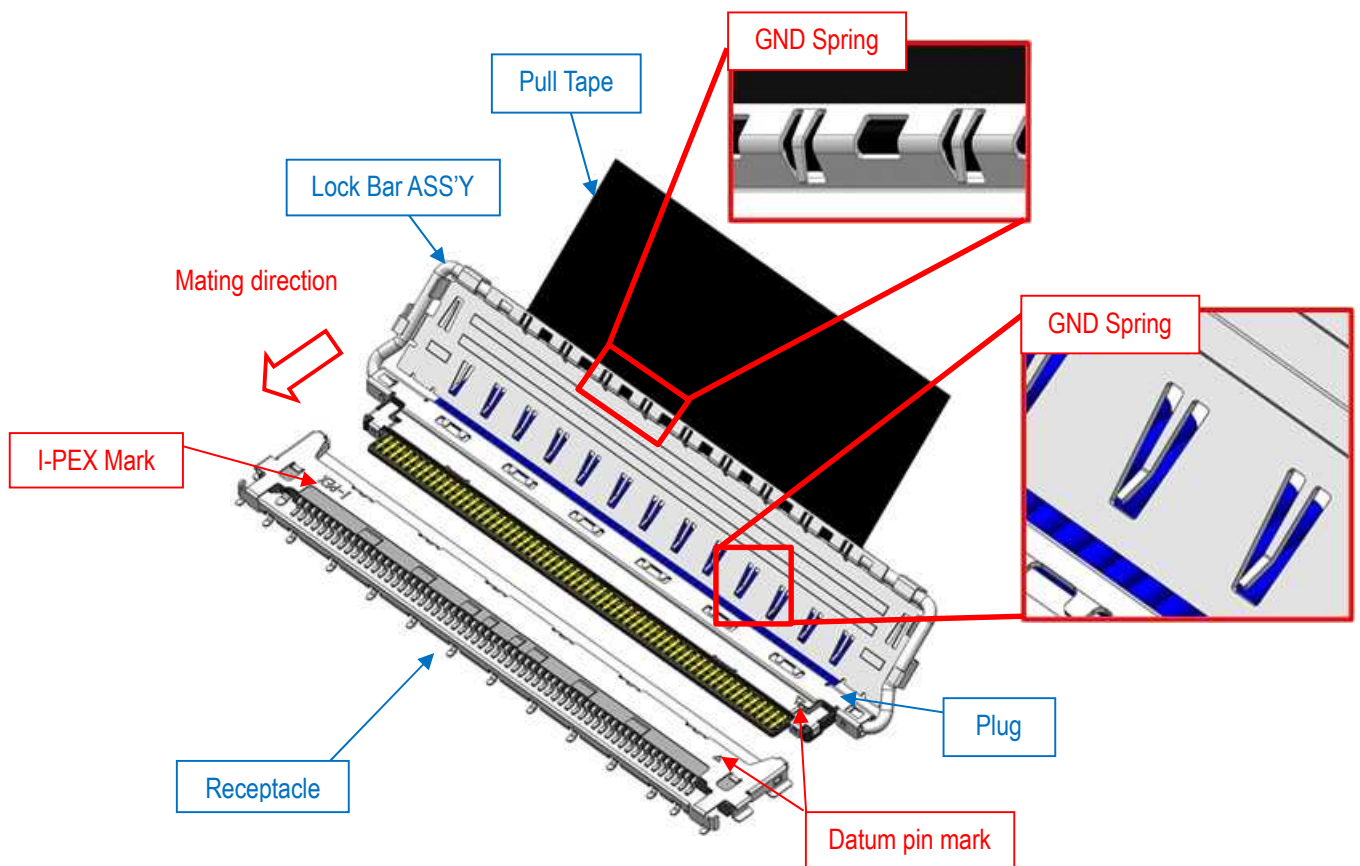

【Connector Insertion Method】

- ① Open the lock bar ass'y. (Fig.1)

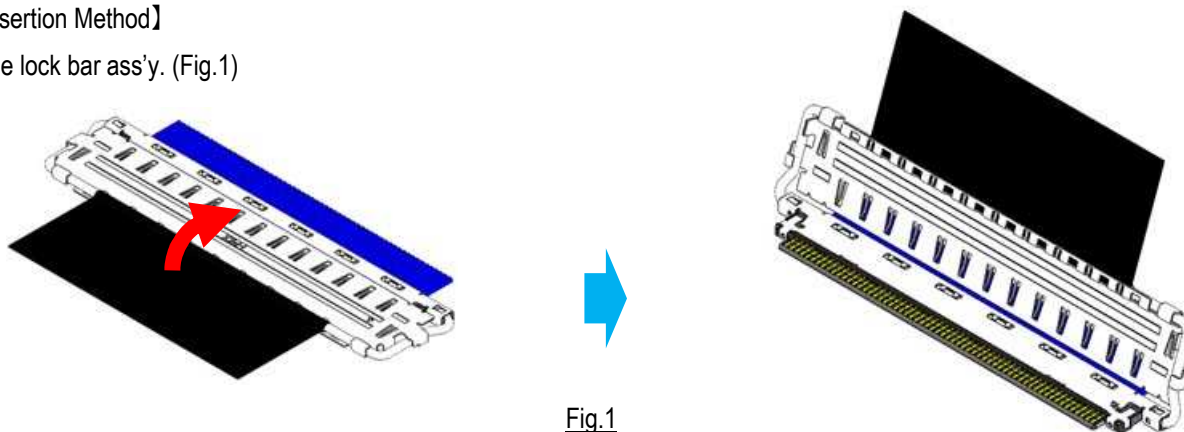

Fig.1

<Caution 1>

If cover is opened up more than its stopped position, cover edge may damage the cable. (Fig.2)

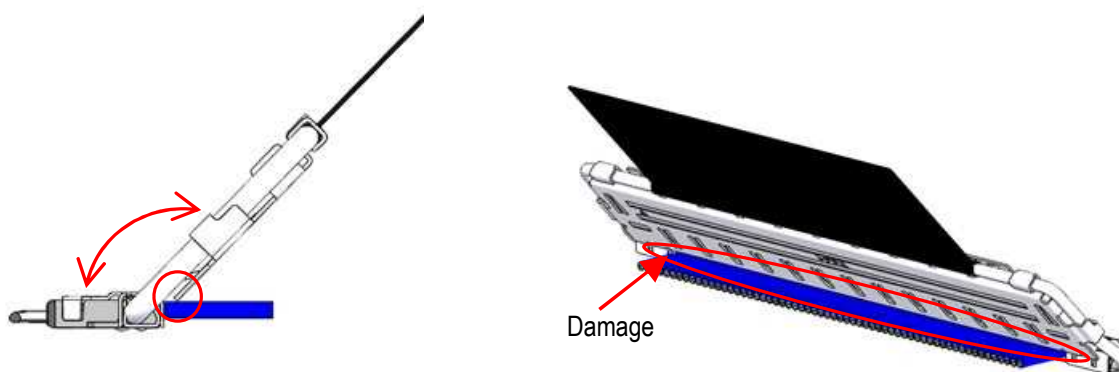

Fig.2

- ② As shown in Fig.3, please set so that the datum pin mark of Plug connector and Receptacle connector are matched.

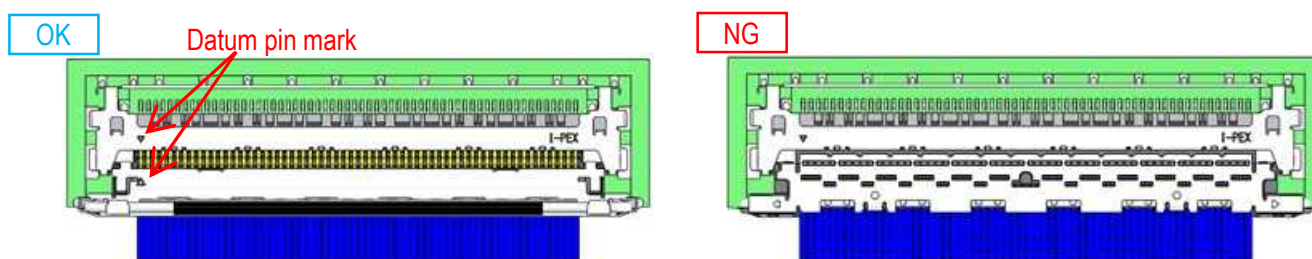

Fig.3

③ Pre-insert the plug connector into the receptacle connector.

The insertion angle in the height direction is within 8° as shown in Fig.4.

The insertion angle in the horizontal direction is within 5° as shown in Fig.5.

(If you insert it beyond the specified angle, the connector may be deformed.)

※Pre-insert without applying excessive load in the insertion direction until both sides of the plug connector overlap the receptacle connector.

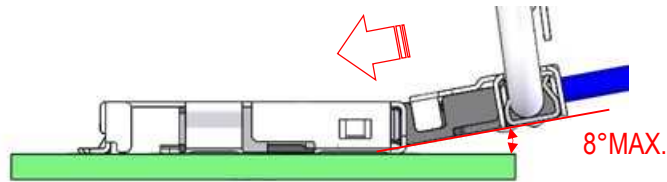

Fig.4



Fig.5

Pre-insert

OK

OK

Check both sides of the plug connector overlap the receptacle connector.



Check the plug connector and receptacle connector are parallel.

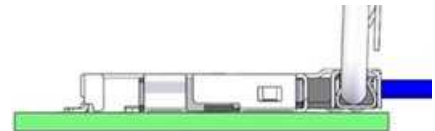

NG

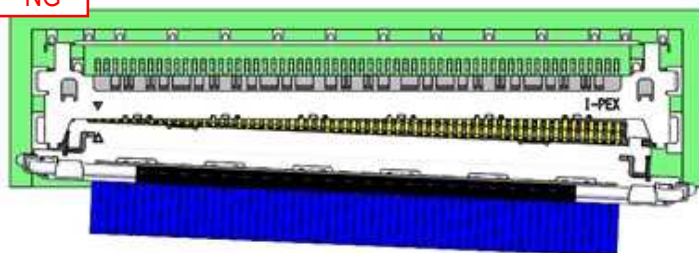
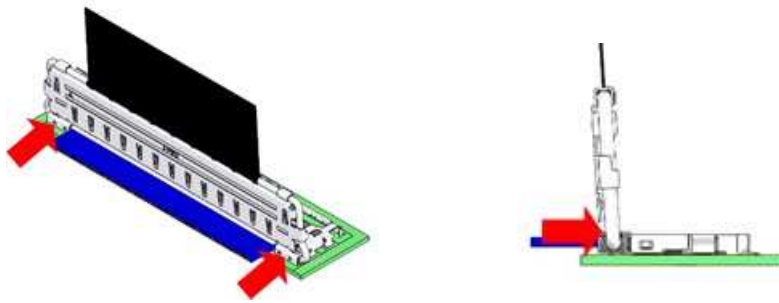

Fig.6

<Caution 2>

If Pre-insert is NG, repeat step ③.

- ④ As shown in Fig.7, push both ends of Plug connector horizontally and confirm there is no gap.



Push both end of connector horizontally

OK



Confirm there is no gap

NG



With gap

Fig.7

<Caution 3>

In inserting, please push both ends of the plug connector horizontally.

When you push one end by one end, there is possibility to cause a gap as shown in Fig.8.



Gap occurs
NG

Fig.8

<Caution 4>

Don't insert the plug connector into the receptacle connector before it has not been pre-insert as shown in Fig.9.
The connector may be damaged.

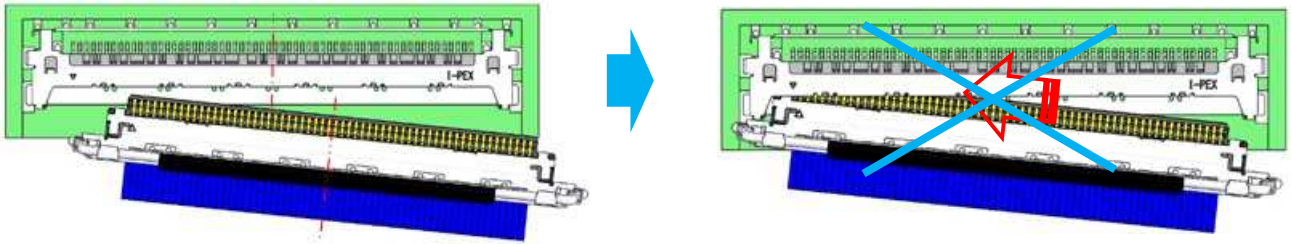
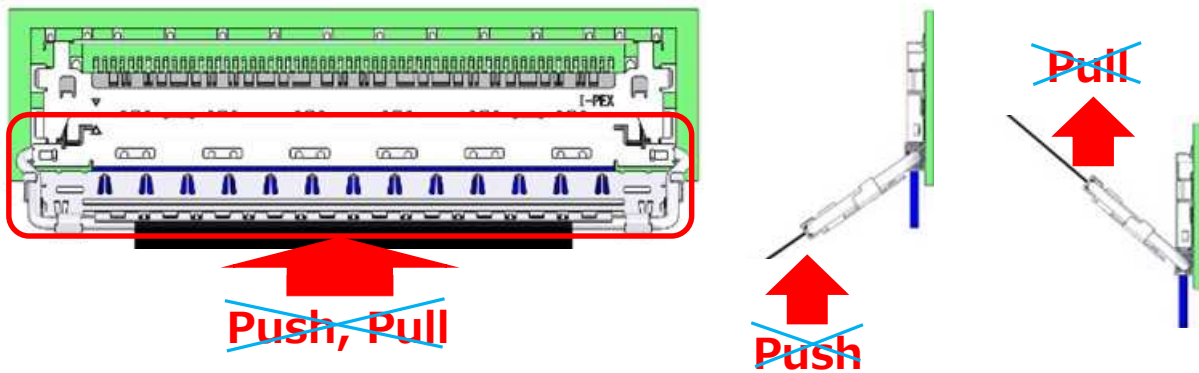

Fig.9

<Caution 5>

The lock bar and cover shall not be pushed or pulled for insertion to avoid deformation or any connector damage.



Do not push or pull Lock bar ass'y when mating the connector.

Fig.10

<Caution 6>

Please do not apply force toward the PCB side to the plug connector in insertion.
PCB will be damaged like below and it may cause the disconnection of the pattern or the short.

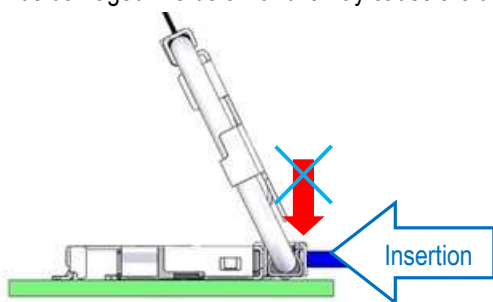

Fig.11

- ⑤ Push **two circled** area of a cover down toward the PCB direction at a same time to lock receptacle shell and lock bar.

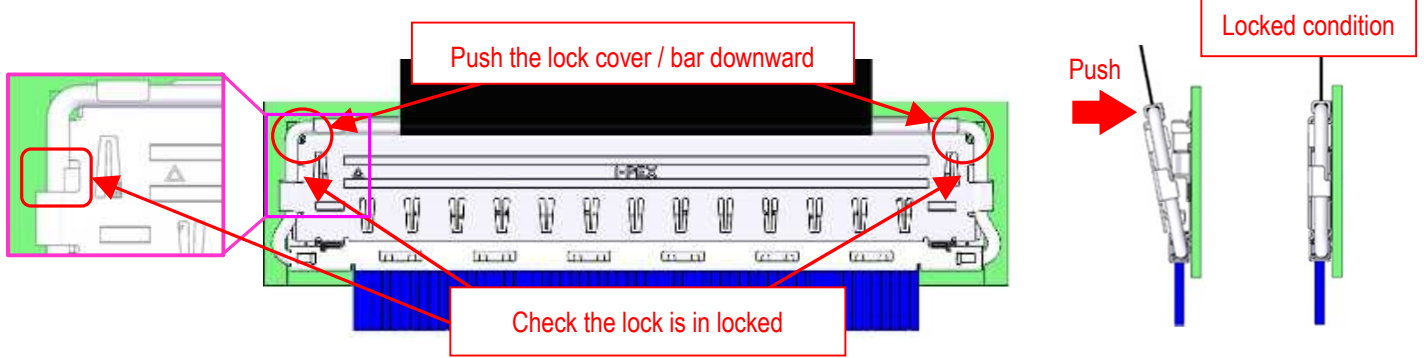

Fig.12

<Caution 7>

Do not close a cover if slant mating was confirmed. Interference of a cover and a receptacle shell may deform the connector.

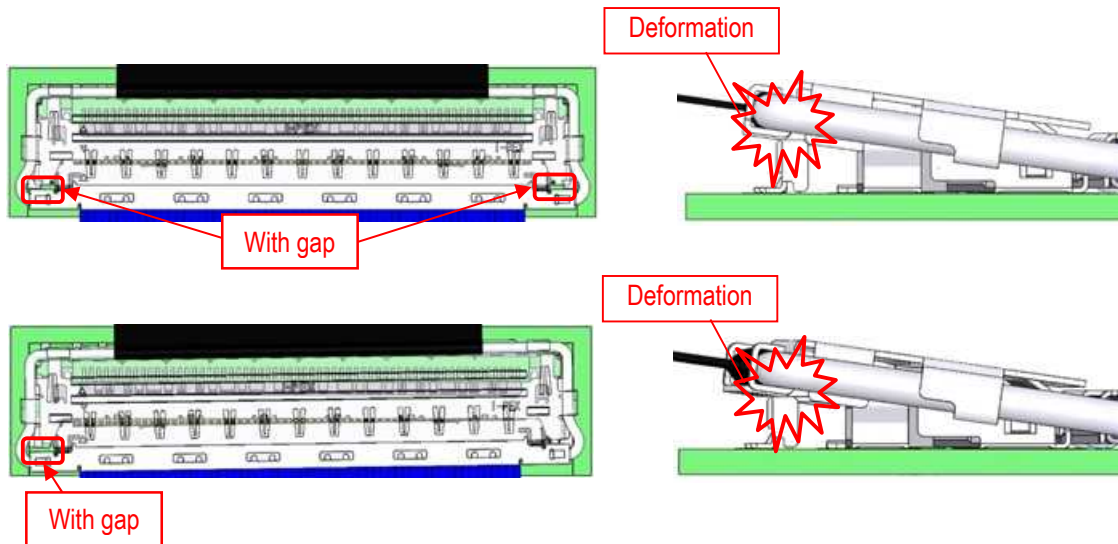

Fig.13

【Connector Withdrawal Method】

- ① Release the lock with the PCB side connector.

For the connector without Pull Tape

Lift the two circled positions of the pull bar upward to release the lock. Then, turn lock bar ass'y as shown in Fig.14.

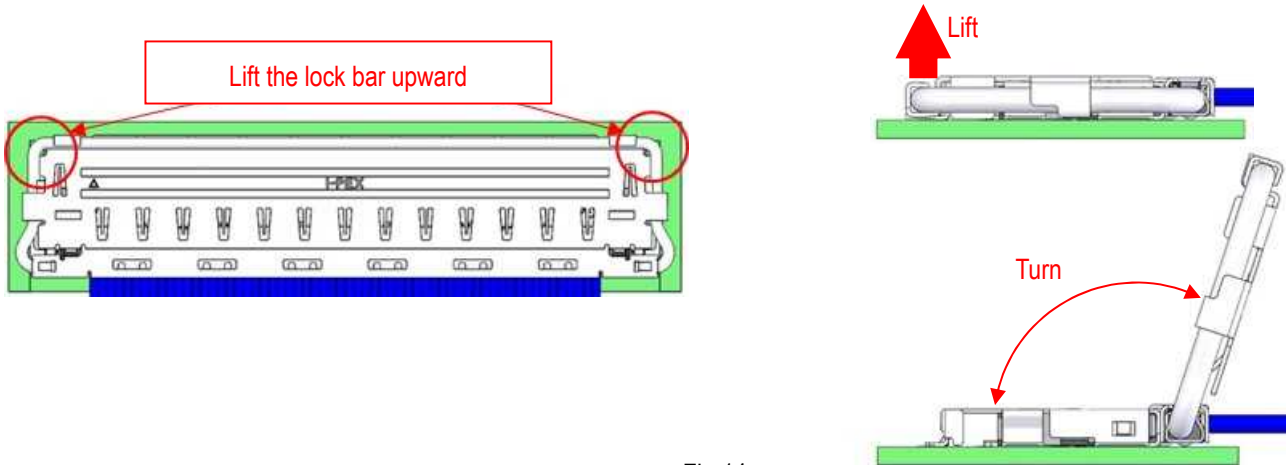

Fig.14

<Caution 8>

When releasing the lock, do not lift by the center of the lock bar ass'y.
There are possibility of lock bar ass'y and connector deformation.

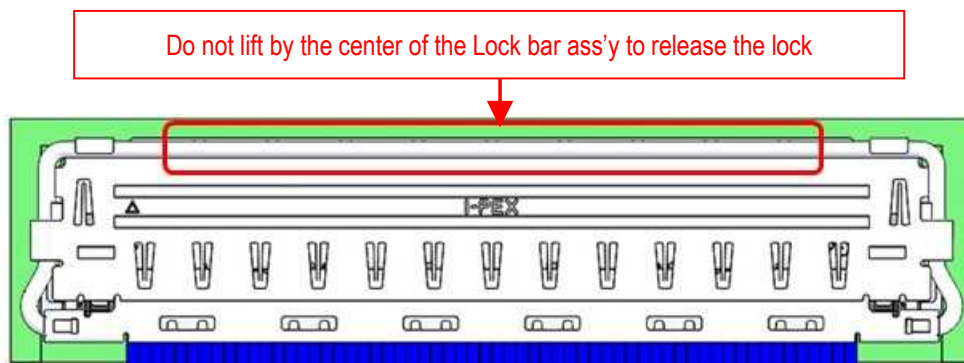

Fig.15

For the connector with Pull Tape

First, pull PULL-TAPE to the direction A and release the lock with the PCB connector.

※ In pulling PULL-TAPE to the direction × mark, there are possibilities to cause

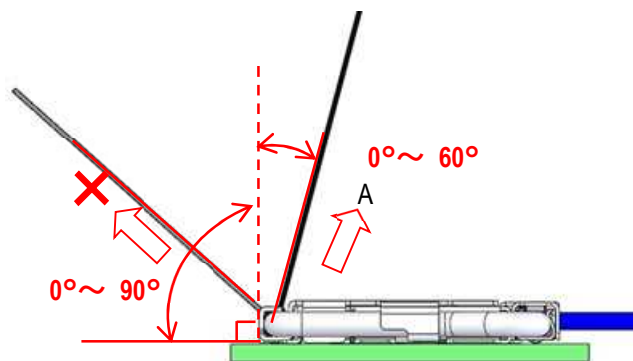

Fig.16

- ② As shown in Fig.17, hold both ends of the Plug connector and withdrawal it parallel.

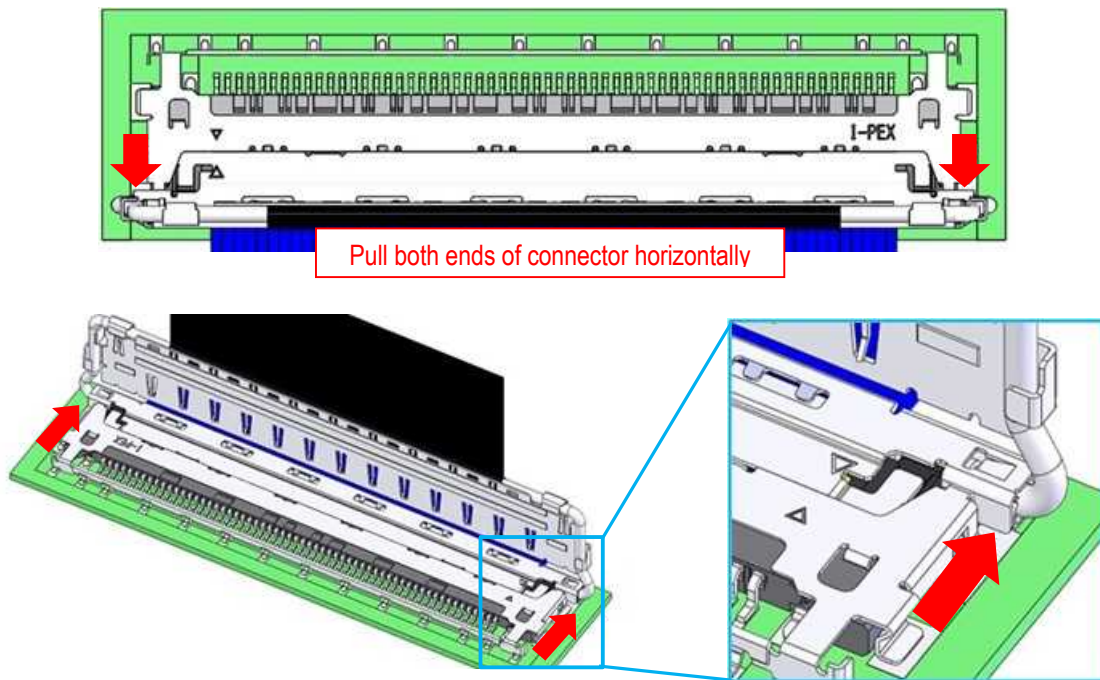

Fig.17

<Caution 9>

Please don't pull out the plug connector at an angle to the receptacle connector.

Please pull out both ends of the plug connector horizontally so that the plug connector does not become slanted during removal.

If you do not, the connector may be damaged.

NG

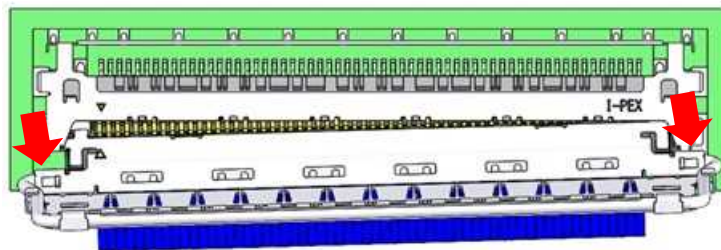

Fig.18

<Caution 10>

Please do not withdraw the connector by pulling the cable. There is possibility to beak the cable.

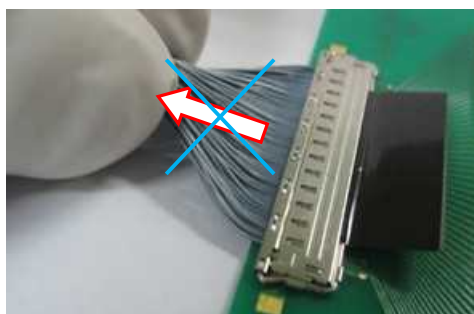

Fig.19

<Caution 11>

Do not withdraw the connector by pulling or pushing the Lock bar ass'y.
There are possibilities to cause the Lock bar ass'y and connector deformation.

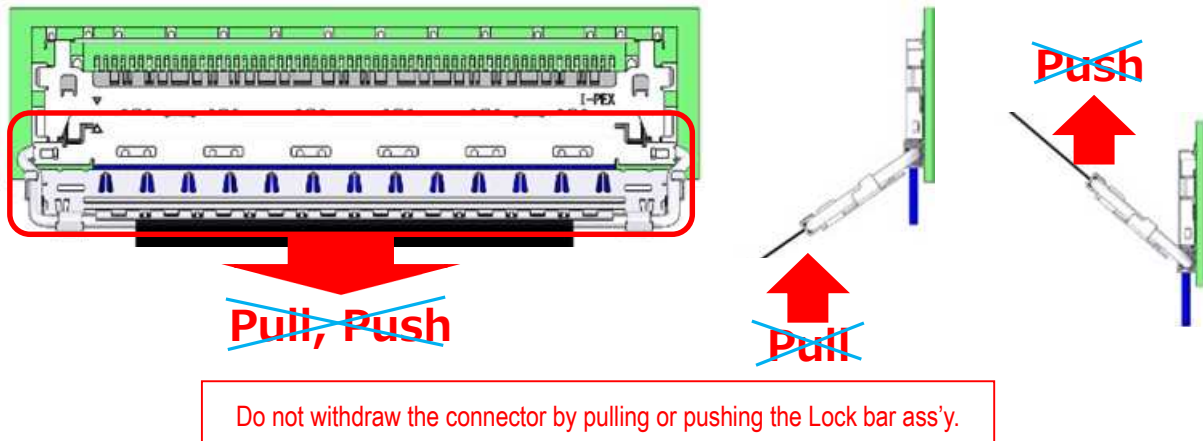

Fig.20

<Caution 12>

Please do not apply force toward the PCB side to the plug connector in withdrawal.
PCB will be damaged like below and it may cause the disconnection of the pattern or the short.

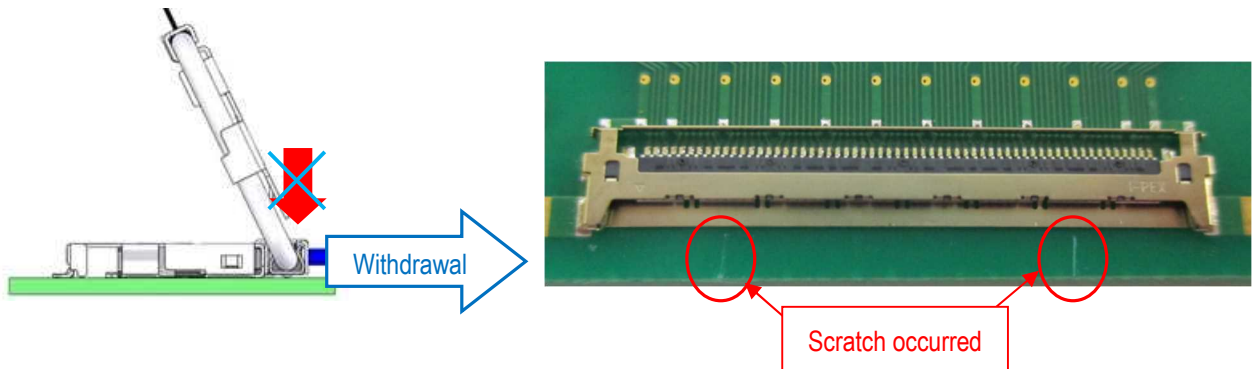

Fig.21

【Cautions in handling the connector】

- ① Please do not pull the cable or the lock bar ass'y of the mated plug connector to the vertical direction.
It may cause the receptacle connector's deformation.

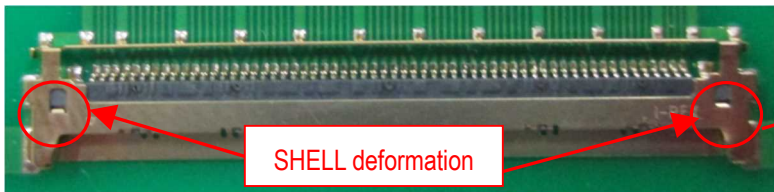
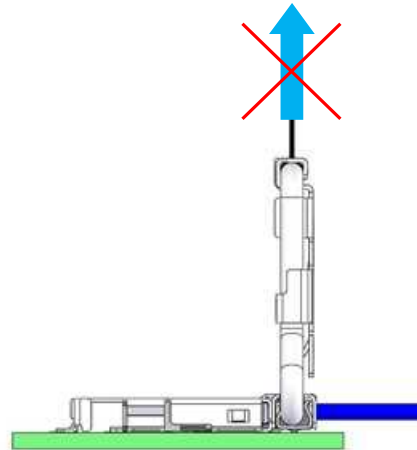
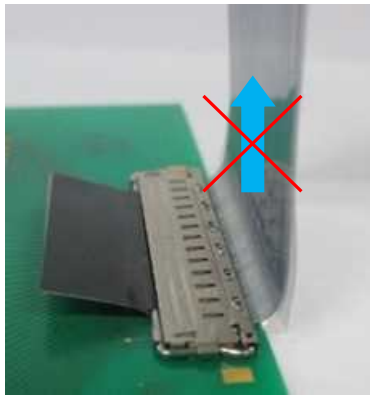

Fig.22

- ② In handling the cable, please pay attention not to apply excessive force to the connector or the cable.
It may cause the connector or the cable breakage.
- ③ Continuous stress to the connector should not remain after assembly.
It may cause the mating defect or the connector breakage.