

Recommended P/N 20615-002R-48

PART No.	PLATING	APPLICABLE CABLE	OUTER CONDUCTOR
20615-001R-48	ALL Au	AWG#38 (0.48 O.D.)	SPIRAL SHIELD
20615-002R-48	SELECTIVE Ni		

Offered as harness only.

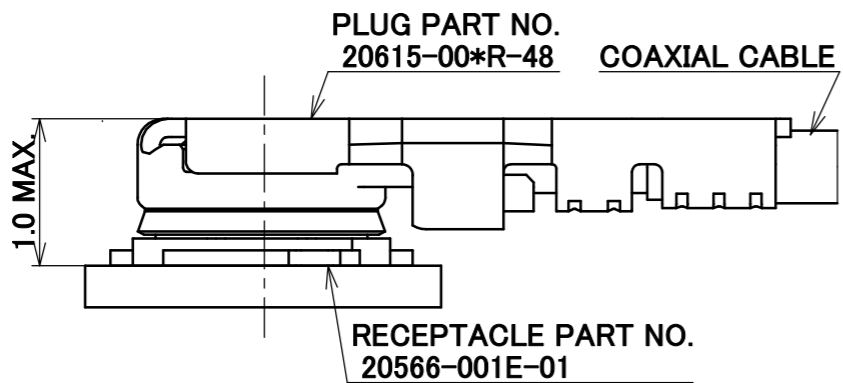
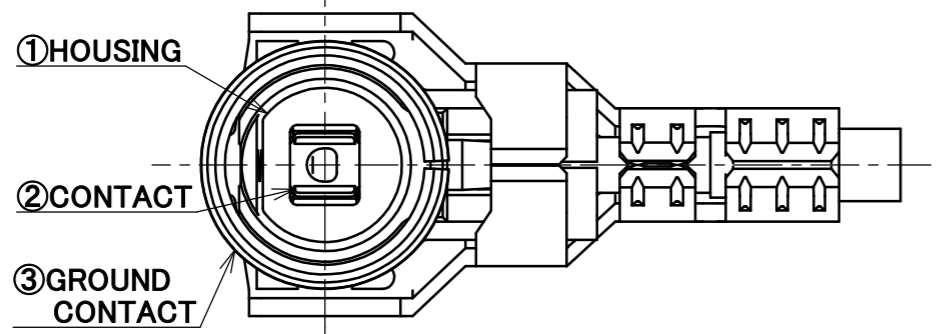
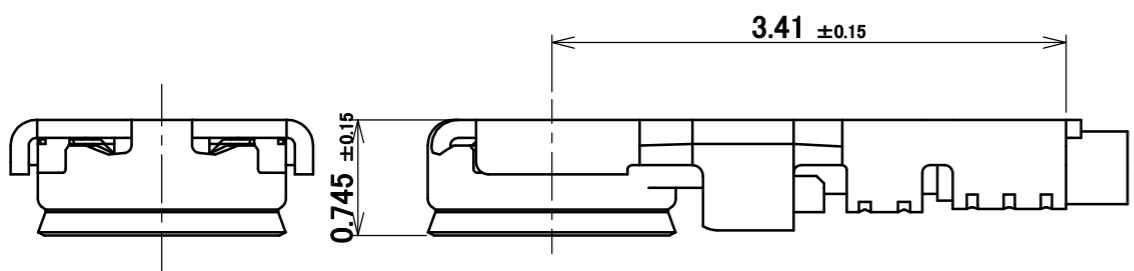
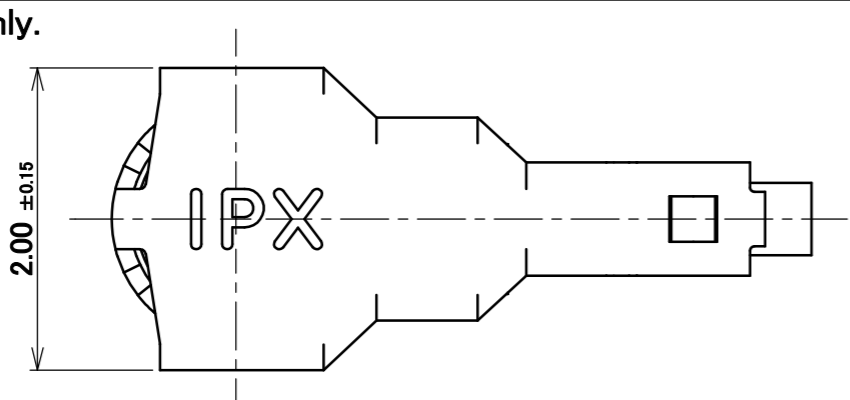

MATING CONDITION

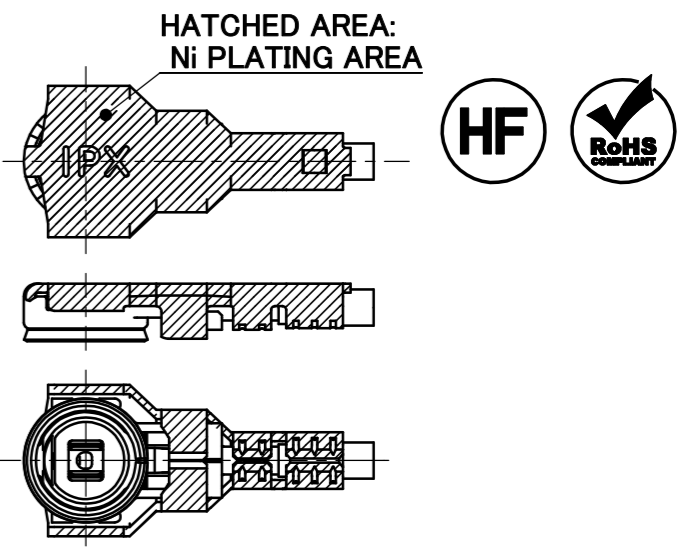
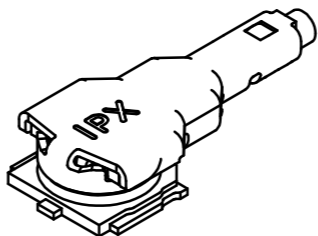

SELECTIVE Ni TYPE (PART NO. 20615-002R-48)

NOTES

- APPLICABLE CONNECTOR: 20566-001E-01
- PERMISSIBLE LOAD OF CABLE AT MATING
- MATING AND UNMATING INSTRUCTION
 - MATING
MATE THE CONNECTOR VERTICALLY AS MUCH AS POSSIBLE, ADJUSTING THE MATING AXIS OF PLUG AND RECEPTACLE. DO NOT SLANT MATE.
 - UNMATING
 - IN CASE OF UNMATING BY PULLING TOOL (PART NO. 90612-0001): USE THE PULLING TOOL AS THE FOLLOWING DRAWING, AND PULL PLUG TO VERTICAL DIRECTION AS DIRECTLY AS POSSIBLE.
 - IN CASE OF UNMATING DIRECTLY BY HAND: CATCH THE CATCHING AREA OF PLUG, AND PULL PLUG TO VERTICAL DIRECTION AS DIRECTLY AS POSSIBLE.
- PRECAUTIONS FOR CABLE POSITION
THE PLUG SHALL NOT BE PLACED WITHIN 50 DEGREES ANGLE FROM CENTER OF THE SIGNAL CONTACT. TILT THE PLUG AT LEAST 50 DEGREES FROM THE CENTER OF A SIGNAL CONTACT.

NOTE 2.

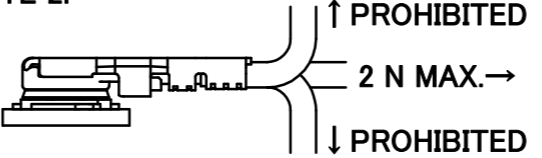

NOTE 3-2-1.

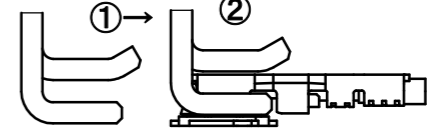

NOTE 4. ALLOWED

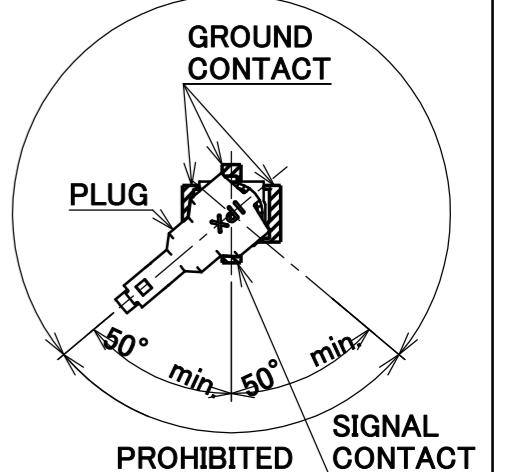

NOTE 3-1.

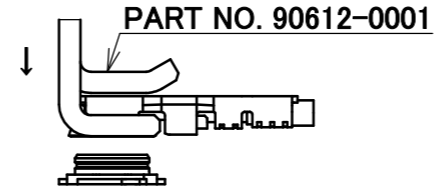

NOTE 3-2-2.

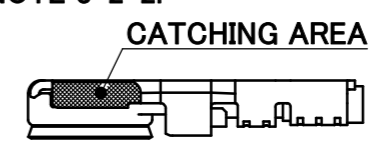

NO.	DESCRIPTION	MATERIAL	FINISH, REMARKS
3	GROUND CONTACT	PHOSPHOR BRONZE	ALL OVER Ni 1.00 μm MIN. CONTACT PART Au 0.05 μm MIN.
2	CONTACT	PHOSPHOR BRONZE	ALL OVER Ni 1.00 μm MIN. CONTACT PART Au 0.05 μm MIN.
1	HOUSING	LCP	UL94V-0, BLACK

4	Z181412	M.N	2018/12/27	Ken	ANGLE ±2° 6 OVER 30 MAX. ±0.3	PROJECTION	SERIES No. R5	CUSTOMER COPY
3	Z170699	M.N	2017/06/19	Ken	6 MAX. ±0.2 30 OVER 120 MAX. ±0.5			
GENERAL TOLERANCE.						TITLE	SCALE	UNIT
2	Z160460	M.N	2016/04/28	Ken	DWG. Y.Hashimoto DATE 2014/03/27			
1	Z141054	Y.H	2014/09/14	Tom	CHK. K.Yotsutani DATE 2014/03/27	DWG. No. 20615	SIZE A3	SHEET 1/3 REV. 4
0	Z140278	Y.H	2014/03/27		APP. T.Takano DATE 2014/03/27			

ITEMS	SPECIFICATION	
	PLUG PART No.	20615-001R-48 (ALL Au PLATING TYPE)
RECOMMENDED APPLICABLE CONNECTOR PART No.	20566-001E-01	
RATING VOLTAGE	60 V AC (R.M.S)	
RATING FREQUENCY	DC~6 GHz	
OPERATING TEMPERATURE	233~363 K (-40°C~+90°C)	
VSWR	1.3 MAX. AT 0.1 ~ 3 GHz, 1.5 MAX. AT 3 ~ 6 GHz	
MAIN CONTACT RESISTANCE	INITIAL: 20 mohm MAX. / AFTER TEST: \triangle R 20 mohm MAX.	
GROUND CONTACT RESISTANCE	INITIAL: 20 mohm MAX. / AFTER TEST: \triangle R 20 mohm MAX.	
INSULATION RESISTANCE	INITIAL: 500 Mohm MIN. / AFTER TEST: 100 Mohm MIN.	
DIELECTRIC WITHSTANDING VOLTAGE	200 V AC, 1 MINUTE	
DURABILITY	30 CYCLES	
UNMATING FORCE (INITIAL / AFTER TEST)	INITIAL: 4 N MIN. / AFTER TEST: 2 N MIN.	
CRIMP STRENGTH	7 N MIN.	
PRODUCT SPECIFICATION	PRS-1939	PRS-2032
TEST REPORT	TR-14026	TR-15029
INSTRUCTION MANUAL	HIM-13003	

ANGLE	$\pm 2^\circ$	6 OVER 30 MAX.	± 0.3	PROJECTION 	SERIES No. R5	CUSTOMER COPY
6 MAX.	± 0.2	30 OVER 120 MAX.	± 0.5			
GENERAL TOLERANCE.				TITLE MHF [®] 5 PLUG (0.48)	SCALE -	
DWG.	DATE					
CHK.	DATE					
APP.	DATE					
DWG. No.				20615	SIZE A3	SHEET 2/3
					REV. 4	

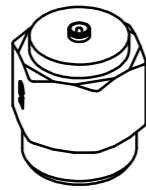

MHF 5 SMA ADAPTOR
PART NO. 90543-0001



FRONT SIDE

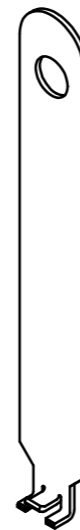

BACK SIDE

MHF 5 PUSHING AND PULLING TOOL
PART NO. 90612-0001



MHF 5 PUSHING TOOL
PART NO. 90624-0001

ANGLE	±2°	6 OVER 30 MAX.	±0.3	PROJECTION ⊕	SERIES No. R5	CUSTOMER COPY	
6 MAX.	±0.2	30 OVER 120 MAX.	±0.5				
GENERAL TOLERANCE.				TITLE MHF® 5 PLUG (0.48)	SCALE 2:1	UNIT mm	
DWG.	DATE						
CHK.	DATE						
APP.	DATE						
				DWG. No.	20615	SIZE A3	
						SHEET 3/3	REV. 4

