

# MINIFLEX® 3-BFN LONG ACTUATOR TYPE

Part No. 20538-0\*\*E-0#

## Packing Standard

8	S19549	September 23, 2019	S.Shigekoshi	M.Muro	H.Ikari
7	S15521	November 6, 2015	R.T		Y.S
6	S15313	July 21, 2015	R.T		E.K
5	S14517	December 16, 2014	Y.S		E.K
Rev.	ECN	Date	Prepared by	Checked by	Approved by

1. 製品名称 (NAME) : MINIFLEX3-BFN ASS'Y 【LONG ACTUATOR TYPE】  
製品番号 (ITEM) : 20538-0\*\*E-0##







## 2. 梱包材料 (PACKING MATERIAL)

芯数 (Pos.)	インボステープ (EMBOSS TAPE) P/N 950420		リール (REEL) P/N 950305		外装カートン (PACKING CARTON) P/N 950000
	テープ幅 (TAPE WIDTH)	厚み (THICKNESS)	リール径 (DIAMETER)	リール幅 (WIDTH)	
33P	24.0	2.5	φ 380	29.4	406×406×214 OUTER
35P					
39P					
41P					
45P					
49P					
51P					
55P	32.0			37.4	
57P					
61P					
65P					

## 3. 梱包数量 (PACKING QTY.)

芯数 (Pos.)	インボステープ入数(リール1本当たり) QTY. IN EMBOSS TAPE (1 REEL)	外装カートン入数(1箱当たり) QTY. IN PACKING CARTON (1 CARTON)
33P	4000	4000 × 5 = 20000 (5 リール(REELS))
35P		
39P		
41P		
45P		
49P		
51P		
55P		4000 × 4 = 16000 (4 リール(REELS))
57P		
61P		
65P		

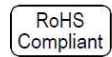
## 4. 現品票 (LABEL)

		20090909011300-00001	
P/N	①	CHECK	捆包卷盘  料带封带  捆包料带 
Q'TY	②	⑥	
LOT	③		
	NAME: ④	REMARK	  MADE IN JAPAN 
	DAI-ICHI SEIKO CO., LTD.		

①... Part number : Ex. 20538-0\*\*E-01

②... QTY.

③... Products lot No.

It is constituted from ten figures.(See below.)

    N    N    N    N    N    N    N    N    N    N    

    A    B    C    D

    A : Last two figures of the Christian era (two figures)

    B : Month (two figures)

    C : Day (two figures)

    D : It is code number that I-PEX uses. (four figures)

Example : 141201F010

It means that the product was manufactured on Dec./01/2014.

④... Item : Ex. MINIFLEX3-BFN LONG ACTUATOR TYPE ASS'Y

⑤... QR Code

⑥... Check stamp

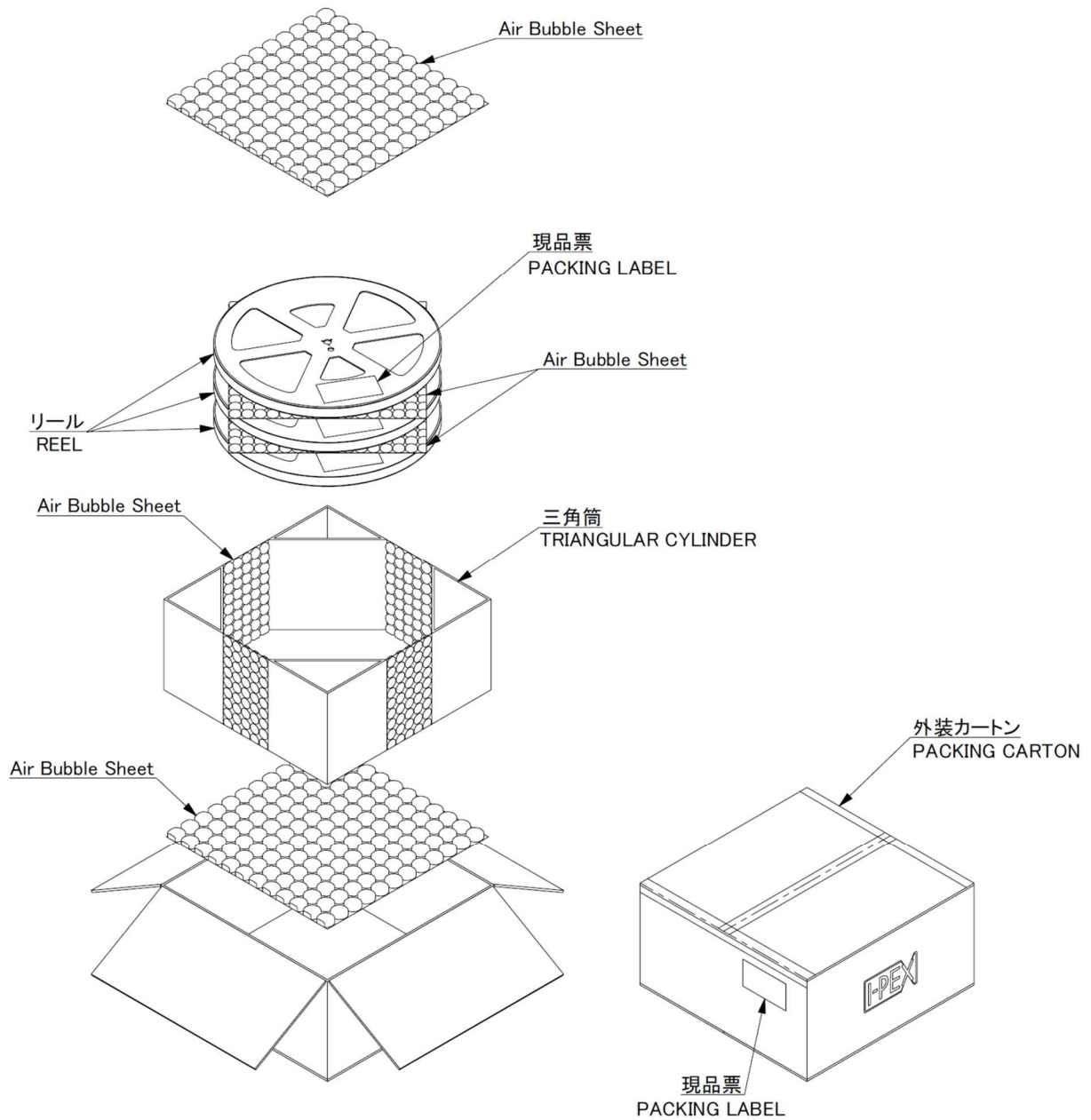

図 1.(Fig.1)