

MINIFLEX® 2-BF LK TYPE

Part No. 20817-120E-01

Packing Standard

Rev.	ECN	Date	Prepared by	Checked by	Approved by
1	S19560	September 24, 2019	S.Shigekoshi	M.Muro	H.Ikari
0	S18202	March 20, 2018	A.Koyanagi	T.Masunaga	H.Ikari

MINIFLEX2-BF LK TYPE Packing Standard

1. 製品名称 (NAME) : MINIFLEX 2-BF LK TYPE ASS'Y
製品番号 (ITEM) : 20817-120E-01







2. 梱包材料 (PACKING MATERIAL)

芯数 (Pos.)	インボステープ° (EMBOSS TAPE) P/N 950462		リール (REEL) P/N 950305		外装カートン (PACKING CARTON) P/N 950000
	テープ幅 (TAPE WIDTH)	厚み (THICKNESS)	リール径 (DIAMETER)	リール幅 (WIDTH)	
120P	44.0	2.83	φ380	49.4	406×406×214 OUTER

3. 梱包数量 (PACKING QTY.)

芯数 (Pos.)	インボステープ° 入数(リール 1 本あたり) QTY. IN EMBOSS TAPE (1 REEL)	外装カートン入数(1 箱あたり) QTY. IN PACKING CARTON (1 CARTON)
120P	4000	4000 × 3 = 12000 (3 リール(REELS))

4. 現品票 (LABEL)

		20090909011300-00001	
P/N	①	CHECK	捆包卷盘  料带封带  捆包料带 
Q'TY	②	⑥	
LOT	③		
	NAME: ④	REMARK	  MADE IN JAPAN 
	DAI-ICHI SEIKO CO., LTD.		

① ... Part number : Ex. 20817-120E-01

② ... QTY.

③ ... Products lot No.

It is constituted from ten figures.(See below.)

 N N N N N N N N N N

 A B C D

 A : Last two figures of the Christian era (two figures)

 B : Month (two figures)

 C : Day (two figures)

 D : It is code Number that I-PEX uses. (four figures)

Example : 180320J010

It means that the Product was manufactured on Mar./20/2018.

④ ... Item : Ex. MINIFLEX 2-BF LK TYPE ASS'Y

⑤ ... QR Code

⑥ ... Check stamp

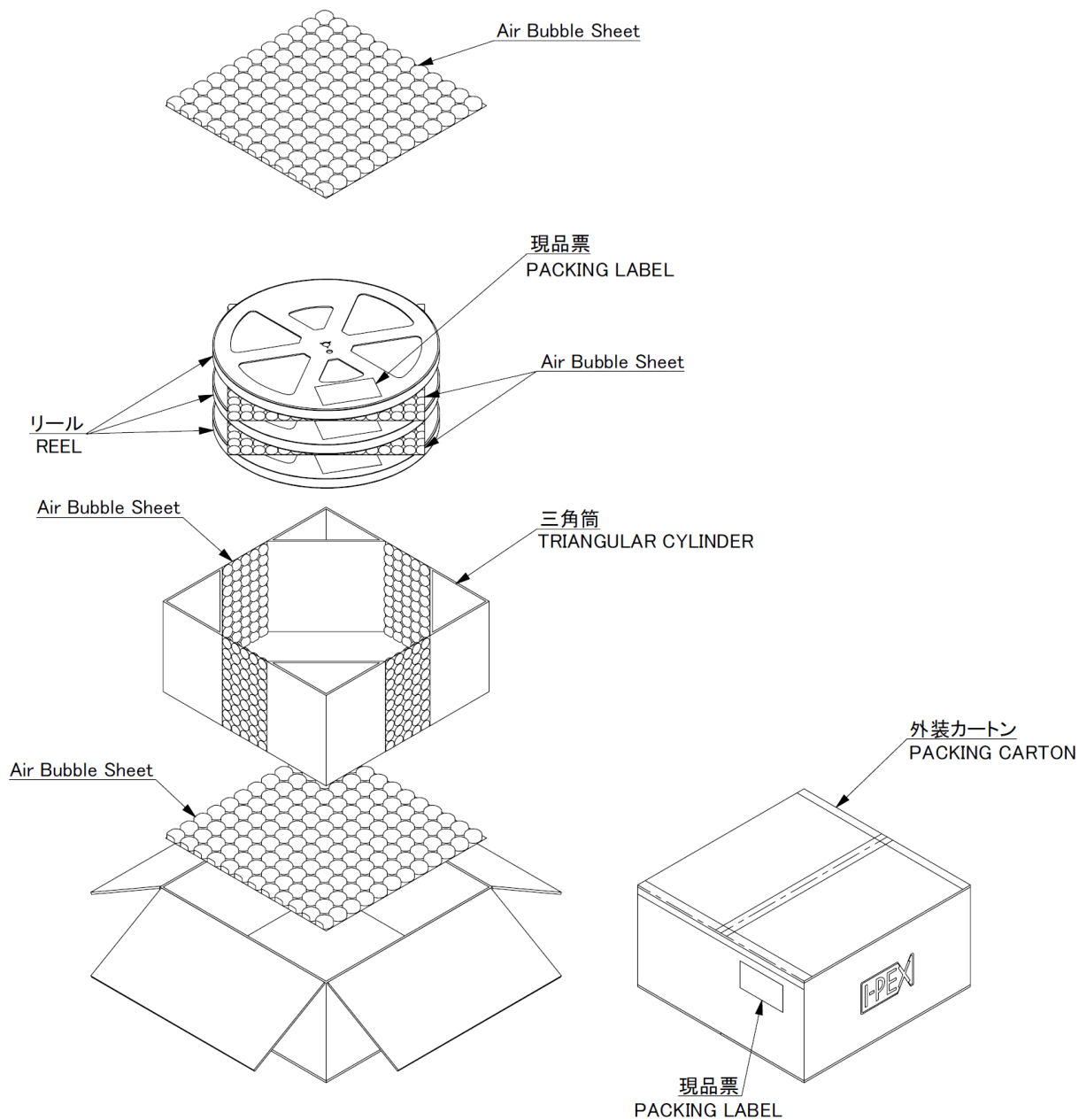

図 1.(Fig.1)