

NOVASTACK® 4

窄款低背設計, 0.4 mm 間距, 高度 0.6 mm, 深度 1.88 mm

Product Specifications:

Board Pitch (mm)	0.4	
Wiping Length (mm)	0.19 (10~50 P), 0.13 (52~80 P)	
Mated Size (mm)	Height	0.6 +/- 0.1
	Width	Formula: $2.50 + (0.4 * ?p/2)$
	Depth	1.88
Current Rating	Signal	0.3 A/pin
	Power	-
Pin Counts	Range	6 - 80
	Available	6, 10, 24, 30, 34, 40

*若有規格外 Pin 數需求, 請與當地負責業務窗口聯繫。

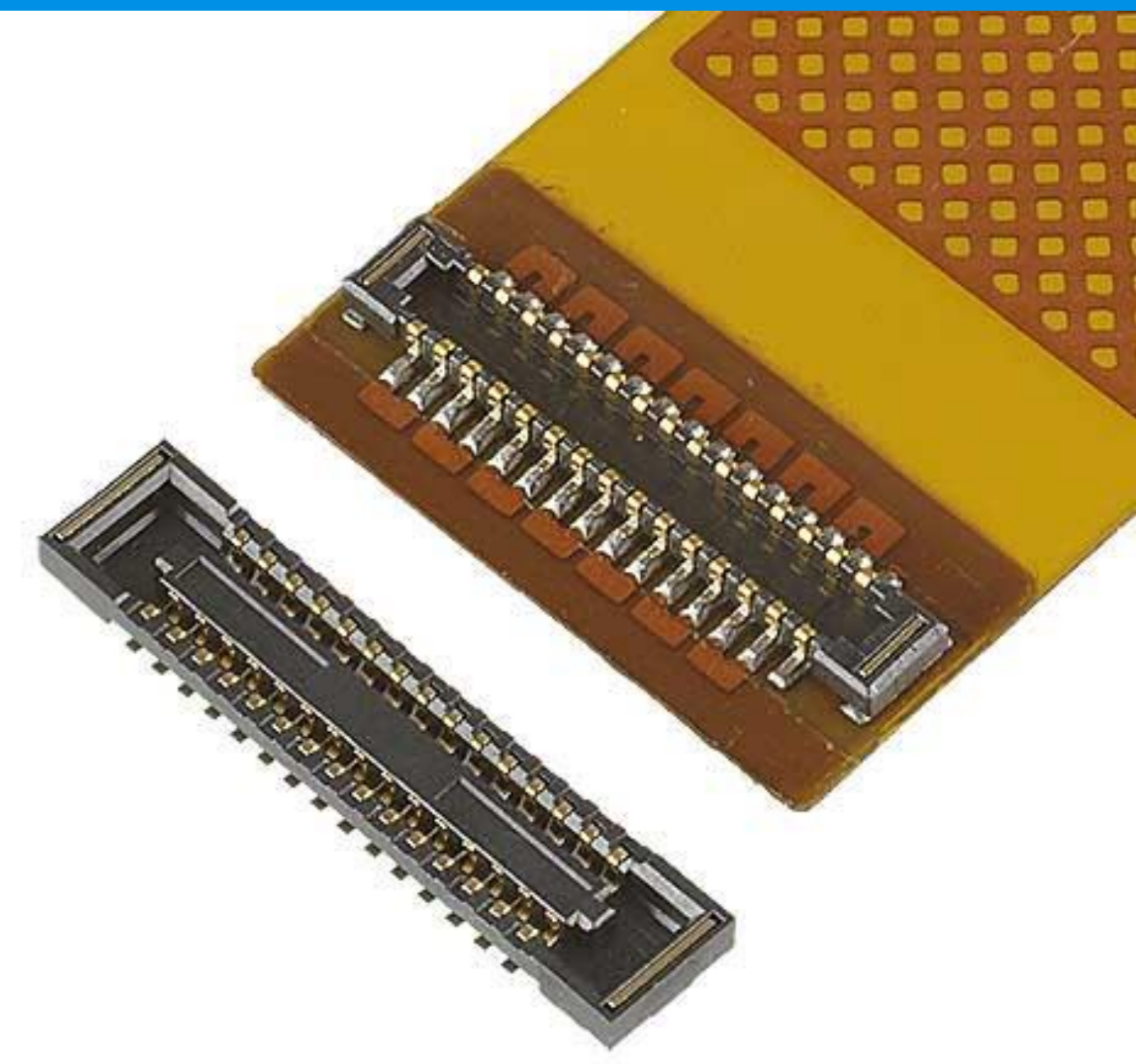

▶ 超窄款式, 深度 1.88 mm

RED: 正在研制

極數	6	10	16	20	24	26	30	34	40	80
其他同行	-	9.5	11.78	13.3	14.82	15.58	17.1	18.62	20.9	36.1
I-PEX	6.96	8.46	10.72	12.22	13.72	14.48	15.98	17.48	19.74	34.78
削減率	-	10.9%	9.0%	8.1%	7.4%	7.1%	6.5%	6.1%	5.6%	3.7%

(Unit: mm²)

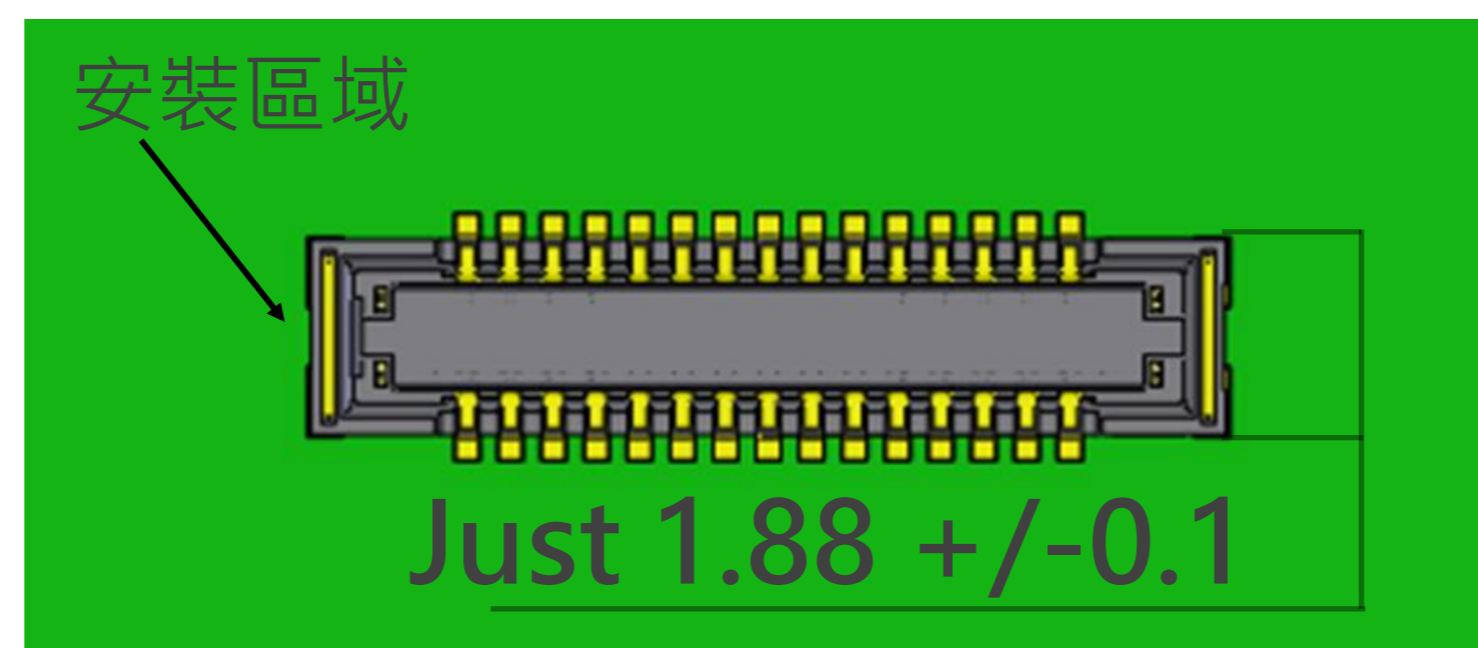

安裝區域節省 4 ~ 11%

▶ 穩定的保持力和插入時的手感

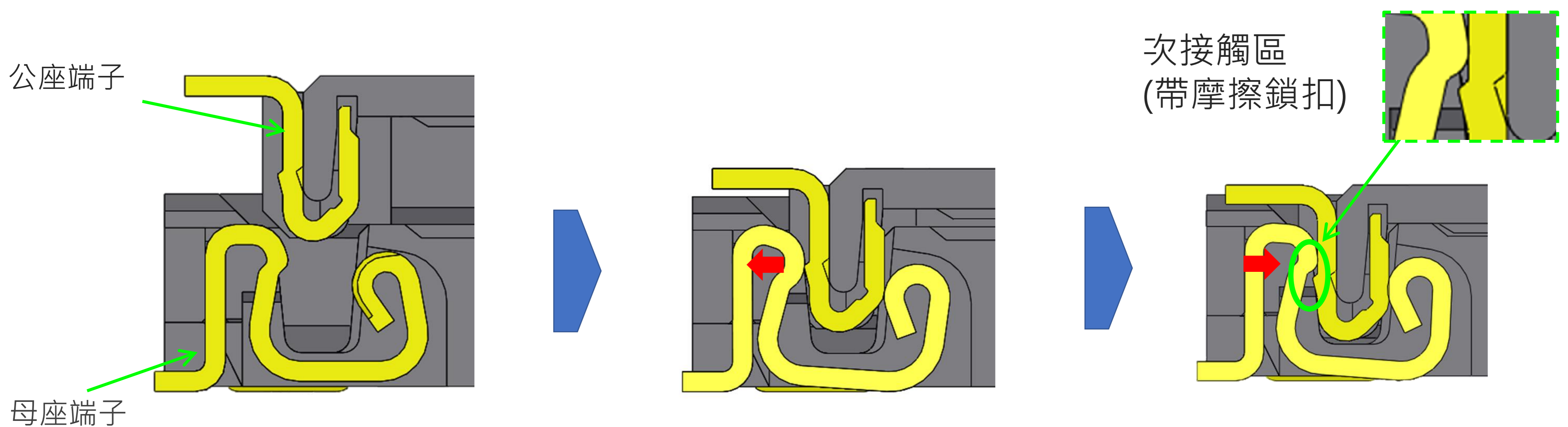

▶ W-point 接觸結構, 實現了高接觸可靠性

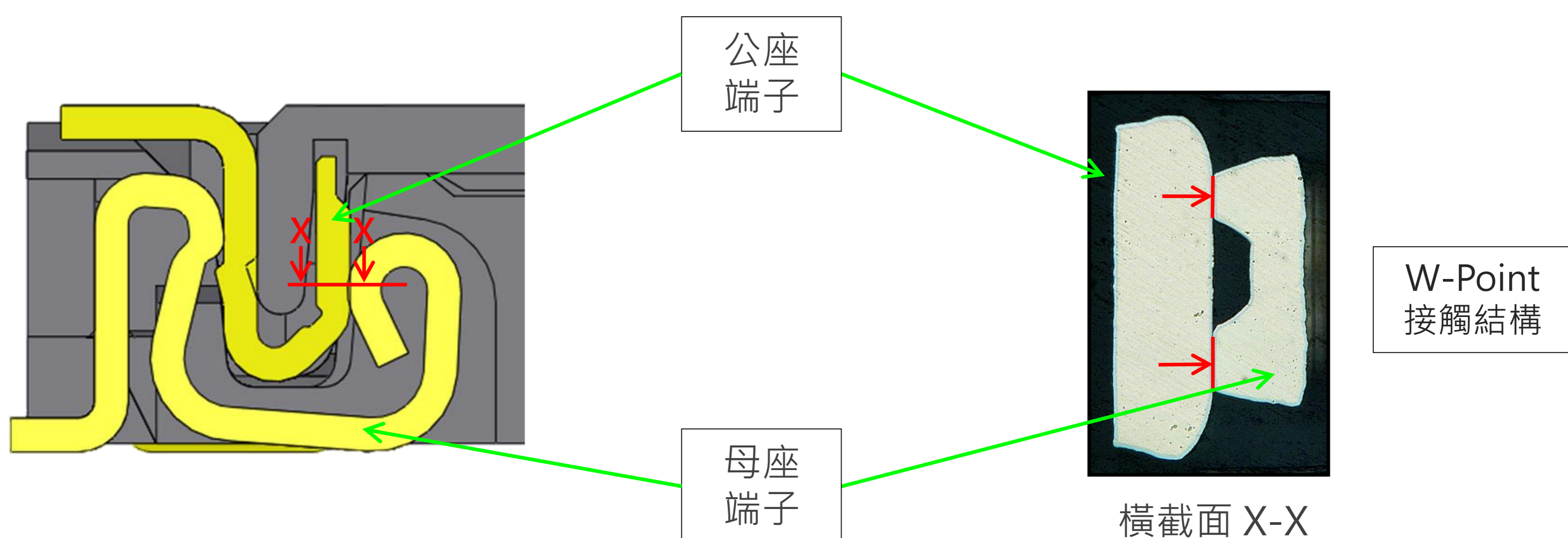

Component Parts Details

Plug Assembly

Recommended P/N		20641-0**E				
PART No.	Pos.	A	B	C	D	E
20641-006E	6	0.80	2.92	2.40	2.47	3.38
20641-010E	10	1.60	3.72	3.20	3.27	4.18
◆ 20641-014E	14	2.40	4.52	4.00	4.07	4.98
◆ 20641-016E	16	2.80	4.92	4.40	4.47	5.38
◆ 20641-020E	20	3.60	5.72	5.20	5.27	6.18
20641-024E	24	4.40	6.52	6.00	6.07	6.98
20641-030E	30	5.60	7.72	7.20	7.27	8.18
20641-034E	34	6.40	8.52	8.00	8.07	8.98
20641-040E	40	7.60	9.72	9.20	9.27	10.18
◆ 20641-080E	80	15.60	17.72	17.20	17.27	18.18

◆ MARK MEANS NOT AVAILABLE.

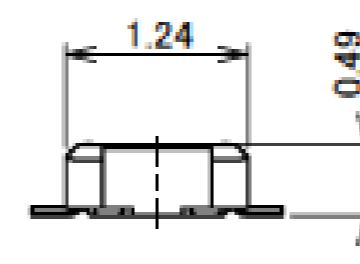
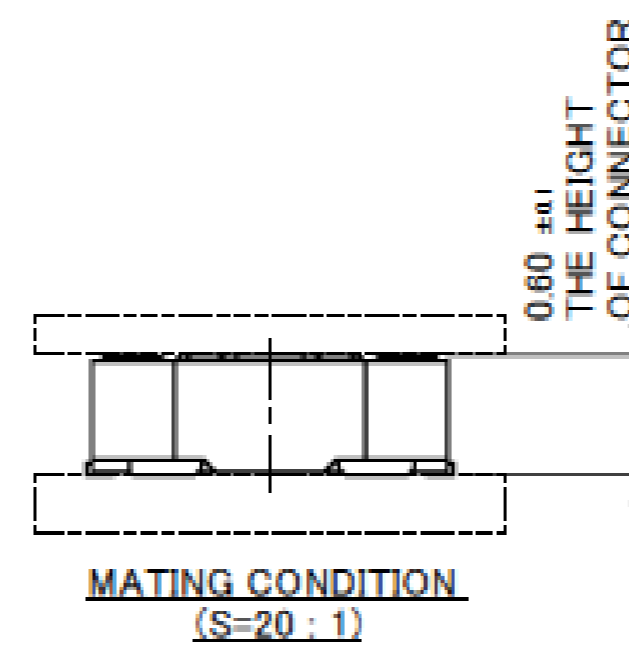
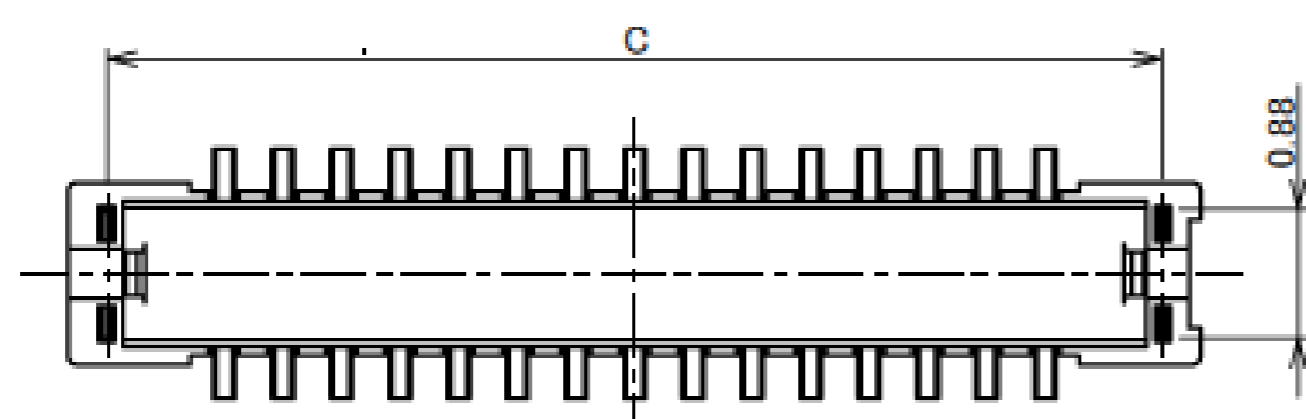
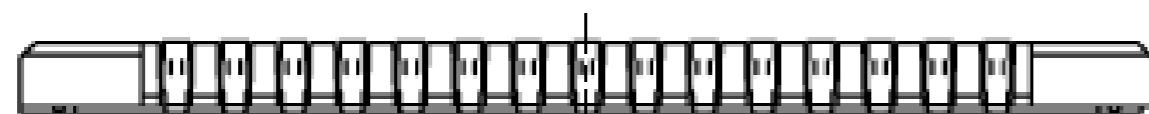
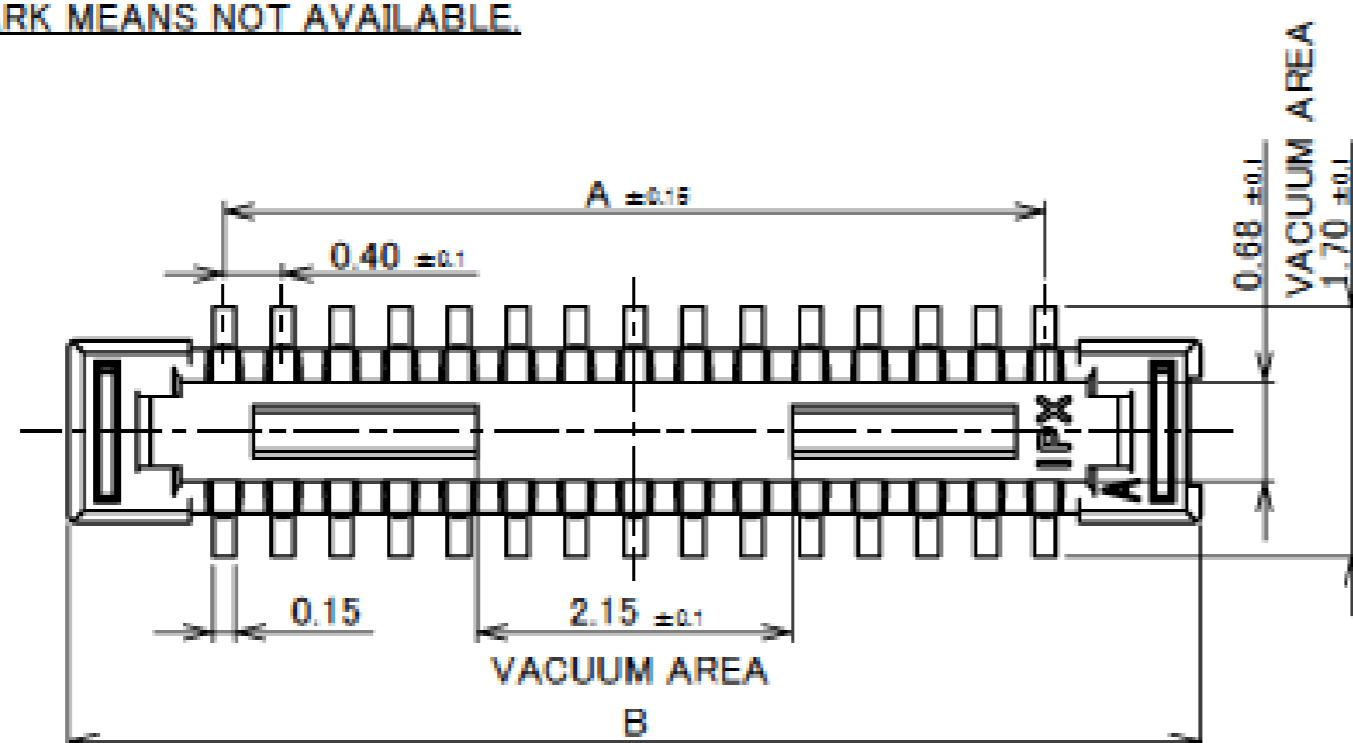

Halogen Free

RoHS Compliant

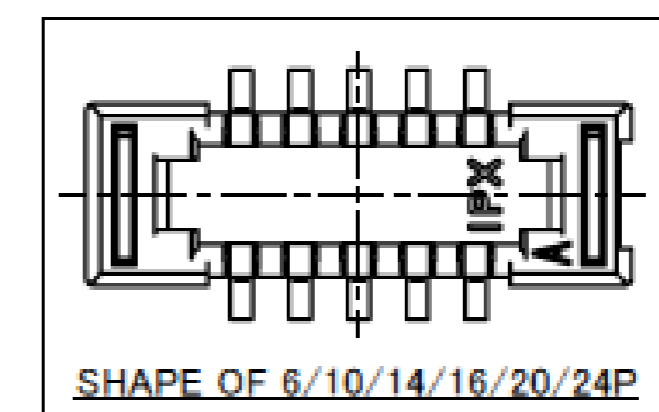
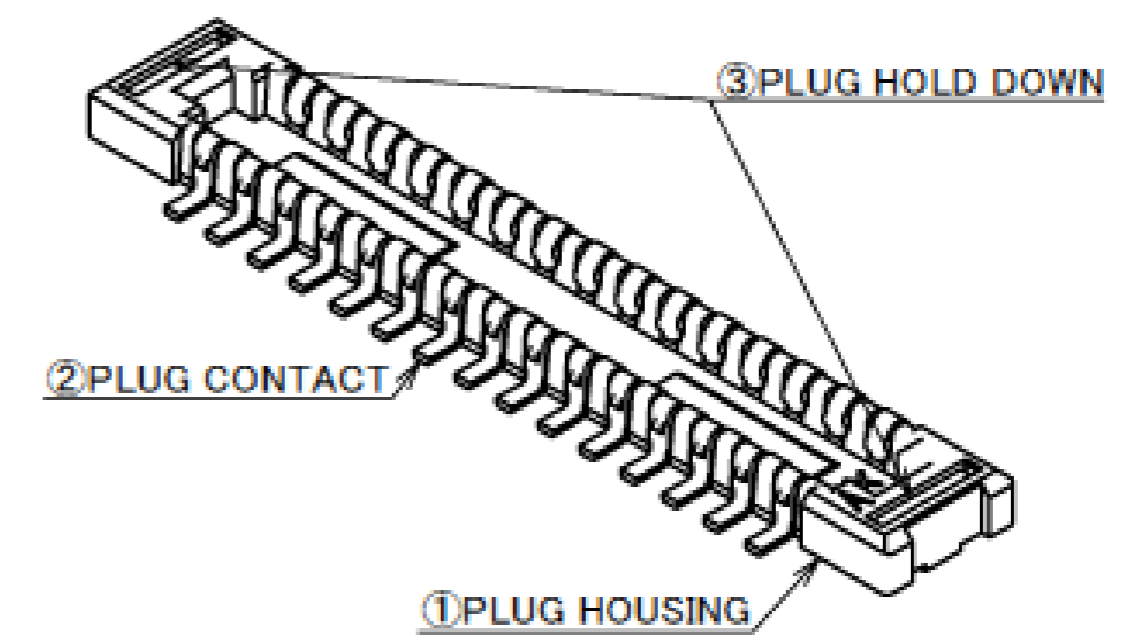

NO	DISCRPTION	MATERIAL	FINISH , REMARKS
3	HOLD DOWN	BRASS	ALL OVER Ni 1.27 μm MIN. SOLDERING PART Au 0.02 μm MIN.
2	CONTACT	PHOSPHOR BRONZE	ALL OVER Ni 1.27 μm MIN. CONTACT PART Au 0.02 μm MIN. SOLDERING PART Au 0.02 μm MIN.
1	HOUSING	LCP	UL94V-0 BLACK

Plug Assembly

Cautions for Handling the Component

1. Using for PCB to FPC connection.

Usage of a FPC stiffener is recommended to prevent plug from damages during insertion and extraction of a FPC.

Recommended stiffener size :

Larger than plug external figure including footprint patterns. (See below)

Recommended FPC and stiffener thickness:

Minimum 0.3 mm

[Thickness example: 0.1 mm FPC + 0.05 mm adhesive bond + 0.15 mm Stiffener (FR-4) = total 0.3 mm]

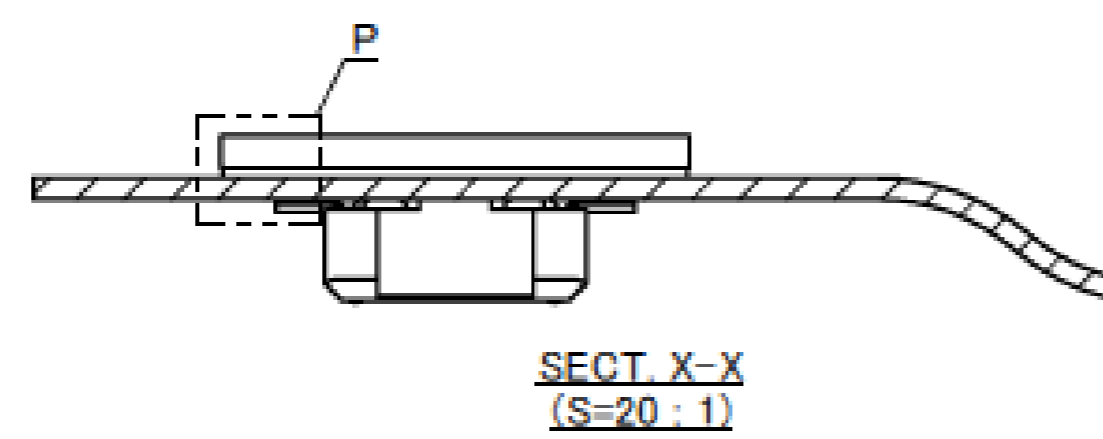
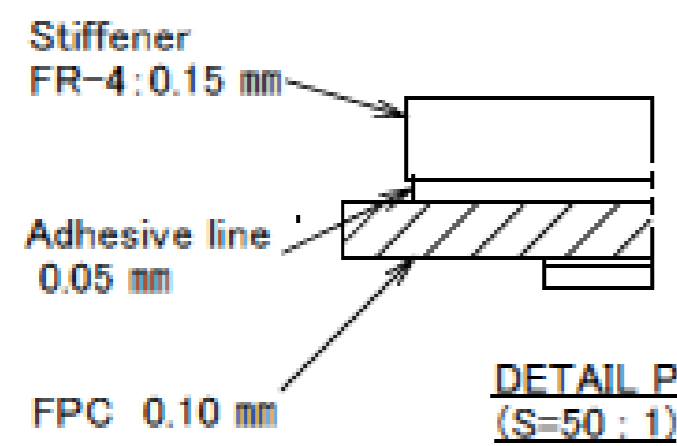
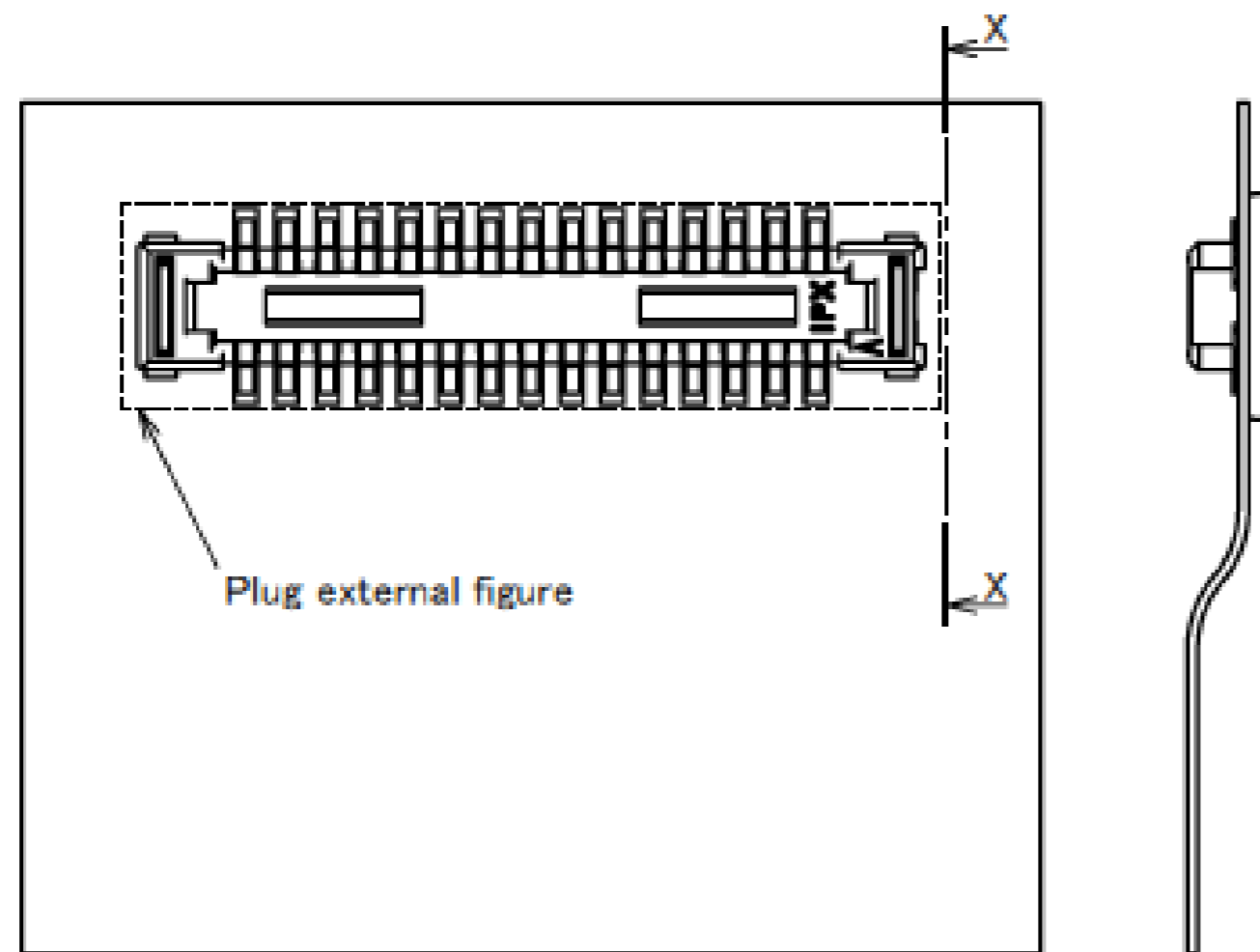

2. Warp of PCB or FPC

PCB /FPC warping is maximum 0.03 mm, with both ends of the plug.

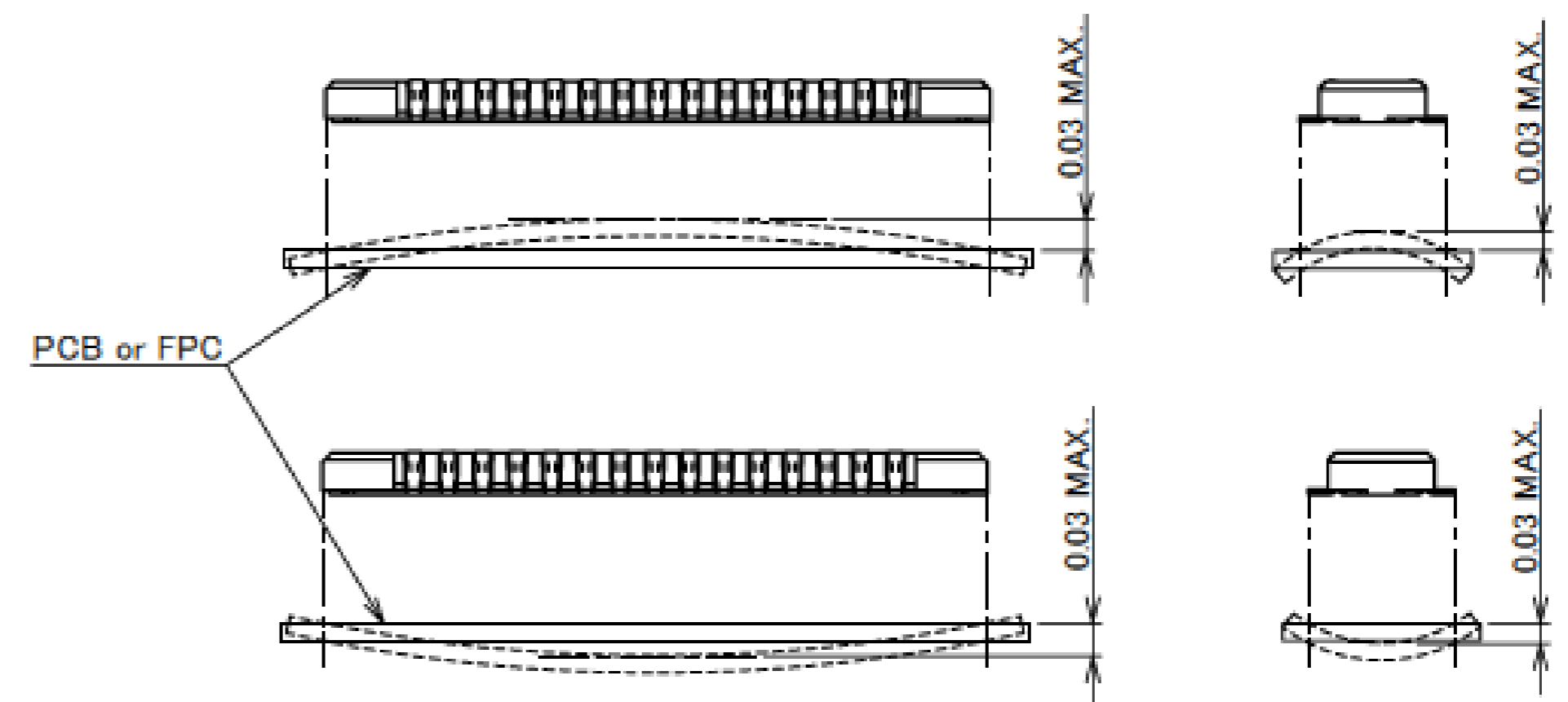

Rev.11

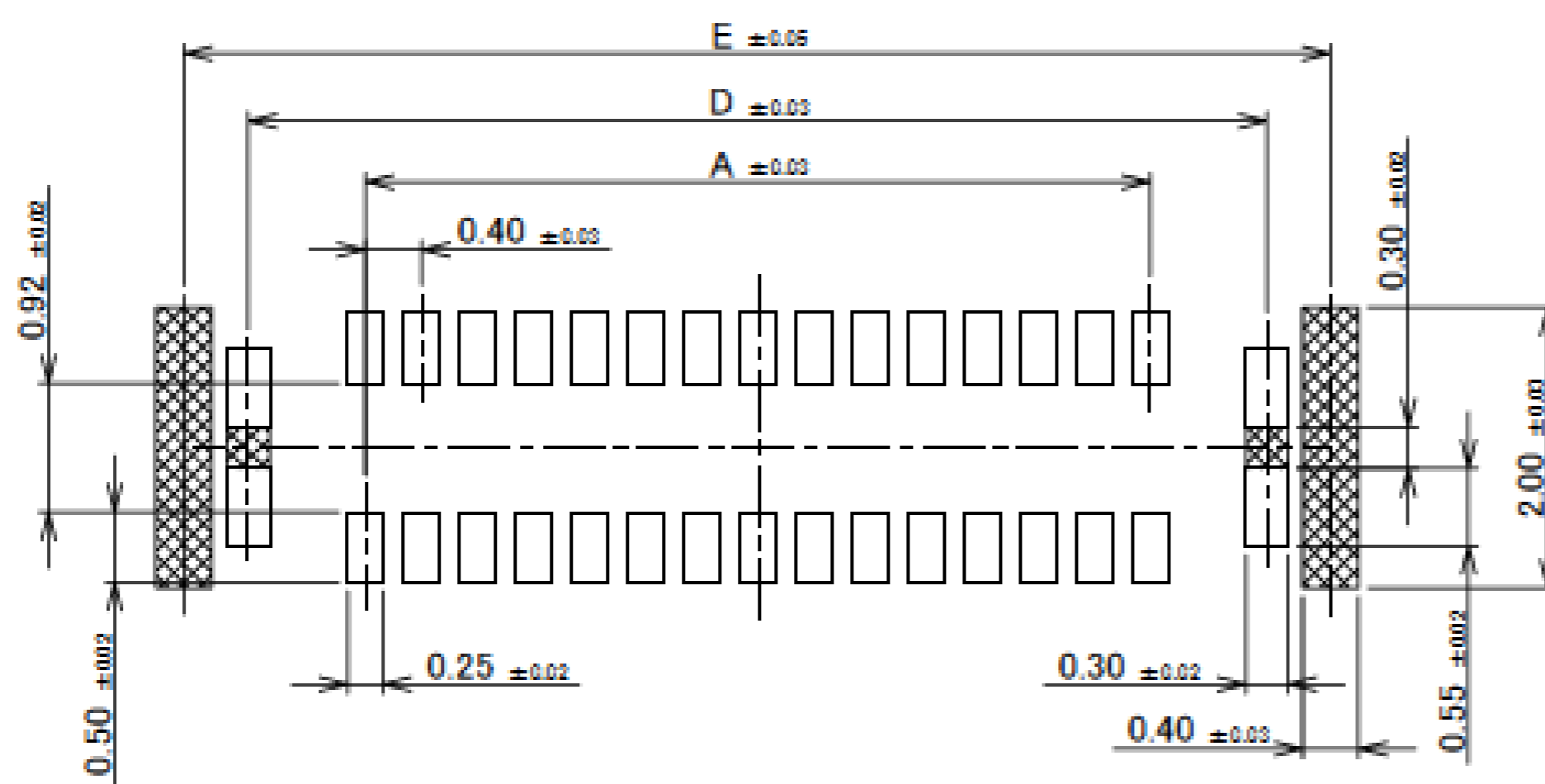

RECOMMENDED PATTERN LAYOUT

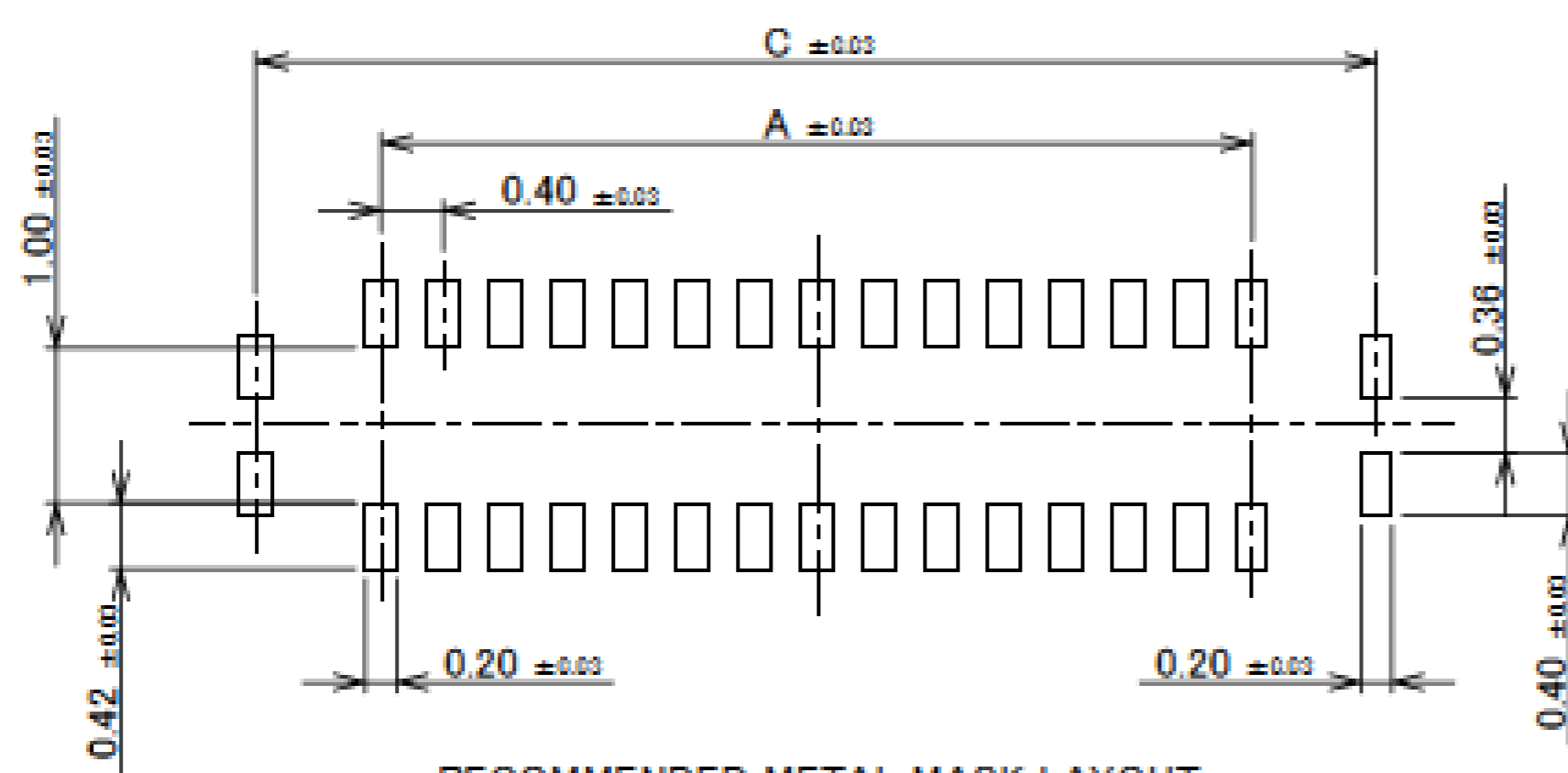

RECOMMENDED METAL MASK LAYOUT
THICKNESS: 0.12 mm

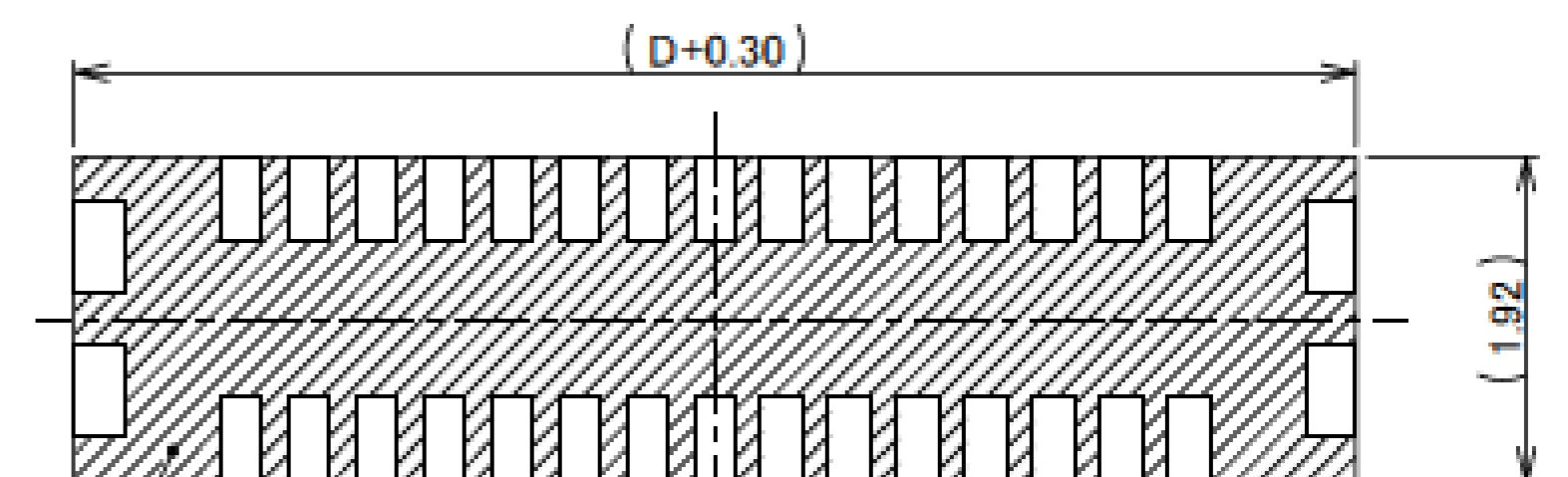

NOTE 1

NOTES

1. THIS AREA CANNOT MOUNT ANOTHER COMPONENTS.

Rev.11

Plug Assembly

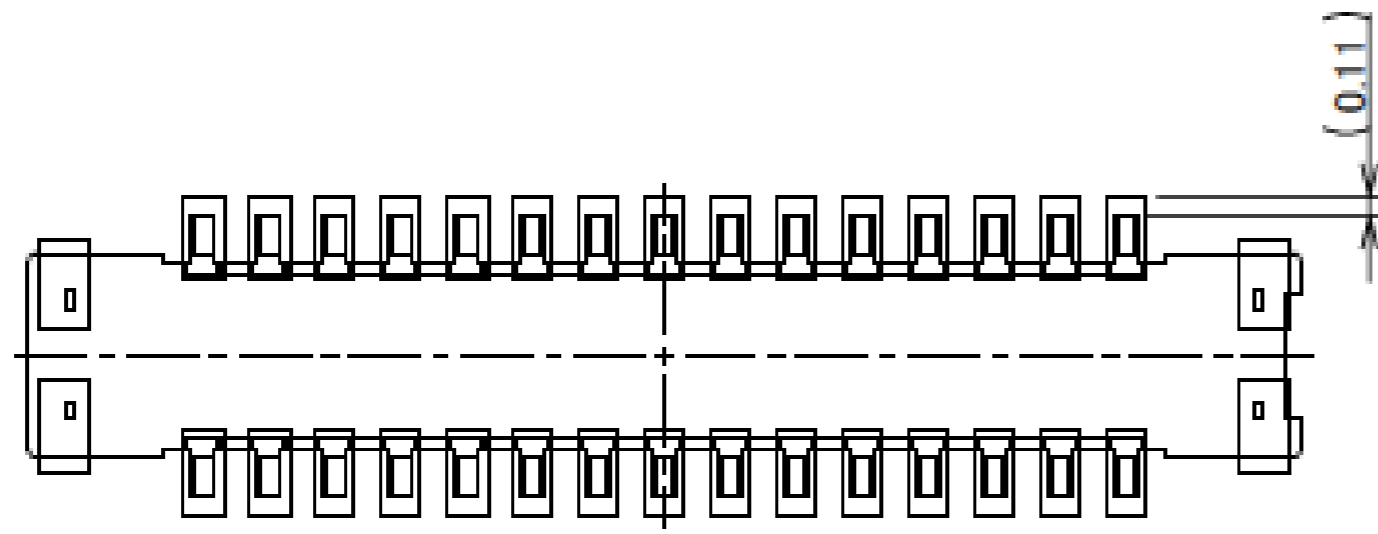

CONNECTOR ON RECOMMENDED FOOTPRINT PATTERN

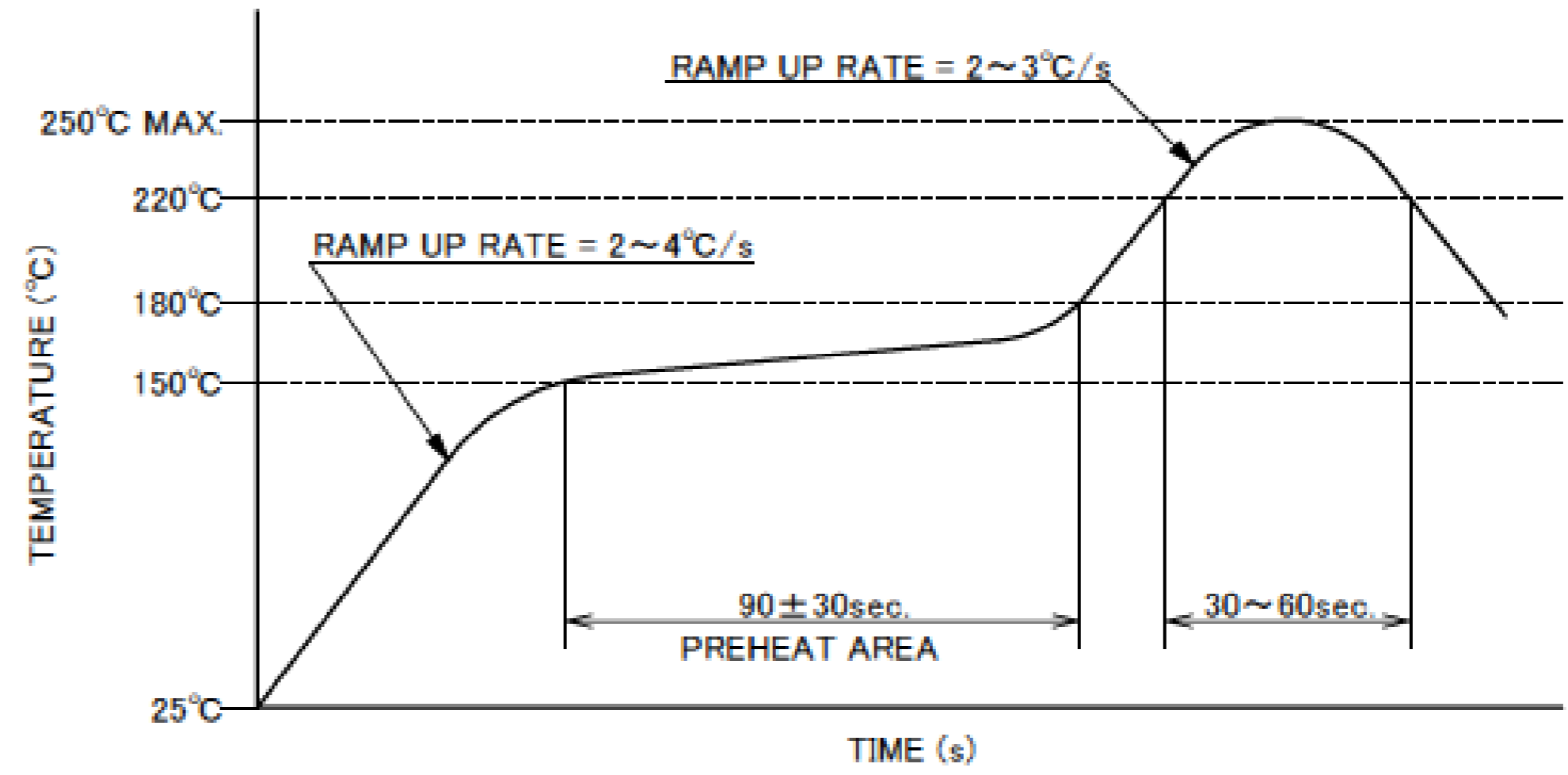

REFLOW TEMPERATURE PROFILE
SENJU METAL INDUSTRY CO., LTD. : M705-SHF(Sn96.5 Ag3.0 Cu0.5)

Rev.11

ITEMS	SPECIFICATION
APPLICABLE CONNECTOR PART No.	20642-0**1E
RATING VOLTAGE	60V AC (PER CONTACT PIN)
RATING AMPERAGE (FOR SIGNAL CONTACT)	0.3A AC/DC (PER CONTACT PIN)
OPERATING TEMPERATURE	233~358K(-40°C~+85°C)
OPERATING HUMIDITY	85% MAX.(NON-CONDENSING)
CONTACT RESISTANCE (FOR SIGNAL CONTACT)	INITIAL : 80mohm MAX. / AFTER TEST : \triangle 20mohm MAX.
INSULATION RESISTANCE	INITIAL : 1,500Mohm MIN. / AFTER TEST : 500Mohm MIN.
DIELECTRIC WITHSTANDING VOLTAGE	AC250V 1min
DURABILITY	30 CYCLES
MATING FORCE (INITIAL)	6P : 10.0N MAX. 30P : 36.0N MAX. 10P : 12.0N MAX. 34P : 40.8N MAX. 24P : 28.8N MAX. 40P : 48.0N MAX.
UNMATING FORCE (AFTER TEST)	6P : 1.2N MIN. 30P : 6.0N MIN. 10P : 2.0N MIN. 34P : 6.8N MIN. 24P : 4.8N MIN. 40P : 8.0N MIN.
COPLANARITY	0.08 MAX.
PRODUCT SPECIFICATION	PRS-1998
TEST REPORT	TR-14088
PACKING STANDARD	PST-14060
INSTRUCTION MANUAL	HIM-14018
APPEARANCE CRITERIA No.	QLS-A***

Rev.11

Receptacle Assembly

Recommended P/N		20642-0**E			
PART No.	Pos.	A	B	C	
20642-006E	6	0.80	3.70	3.38	
20642-010E	10	1.60	4.50	4.18	
◆ 20642-014E	14	2.40	5.30	4.98	
◆ 20642-016E	16	2.80	5.70	5.38	
◆ 20642-020E	20	3.60	6.50	6.18	
20642-024E	24	4.40	7.30	6.98	
20642-030E	30	5.60	8.50	8.18	
20642-034E	34	6.40	9.30	8.98	
20642-040E	40	7.60	10.50	10.18	
◆ 20642-080E	80	15.60	18.50	18.18	

◆ : MARK MEANS NOT AVAILABLE.

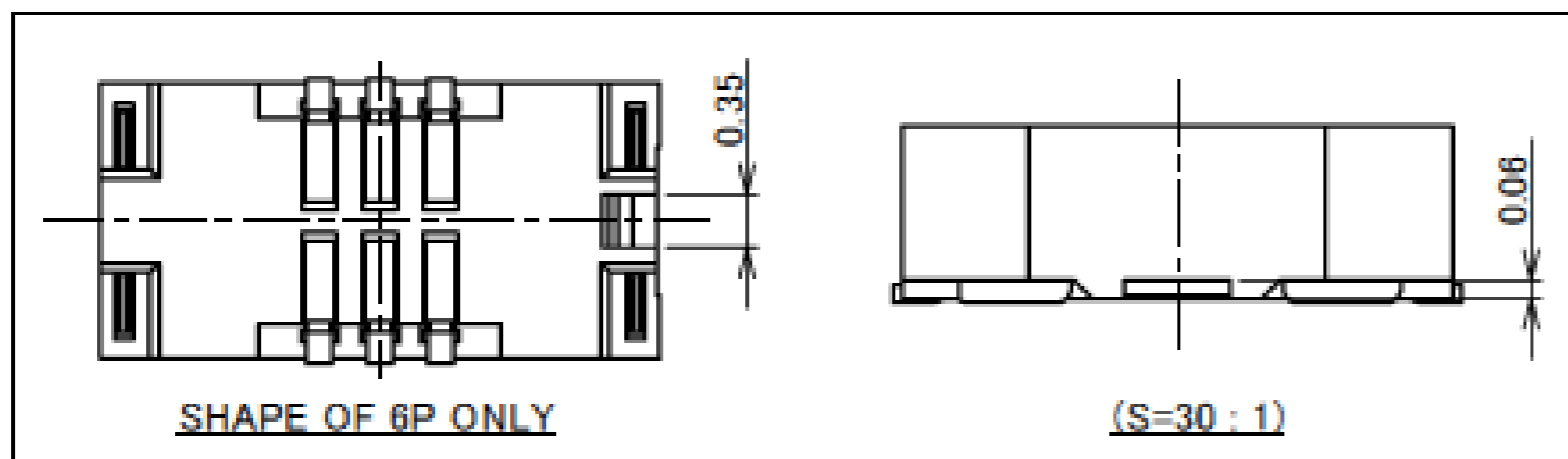
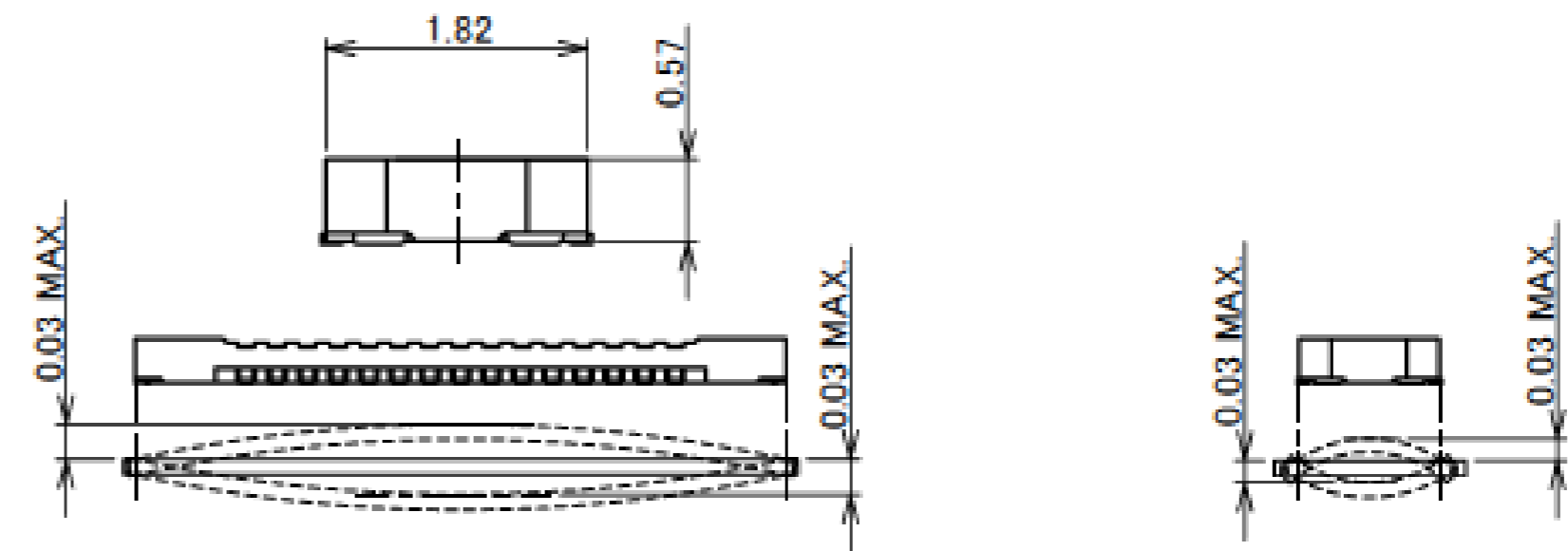
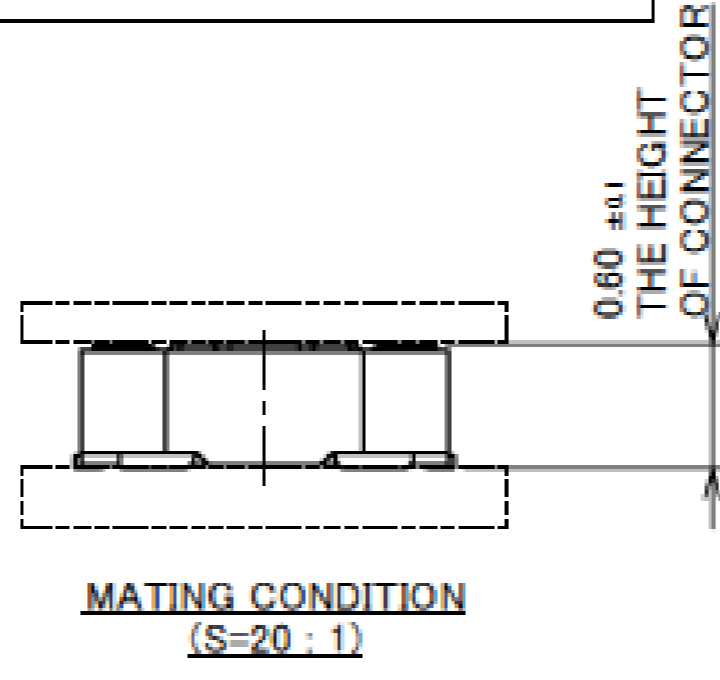
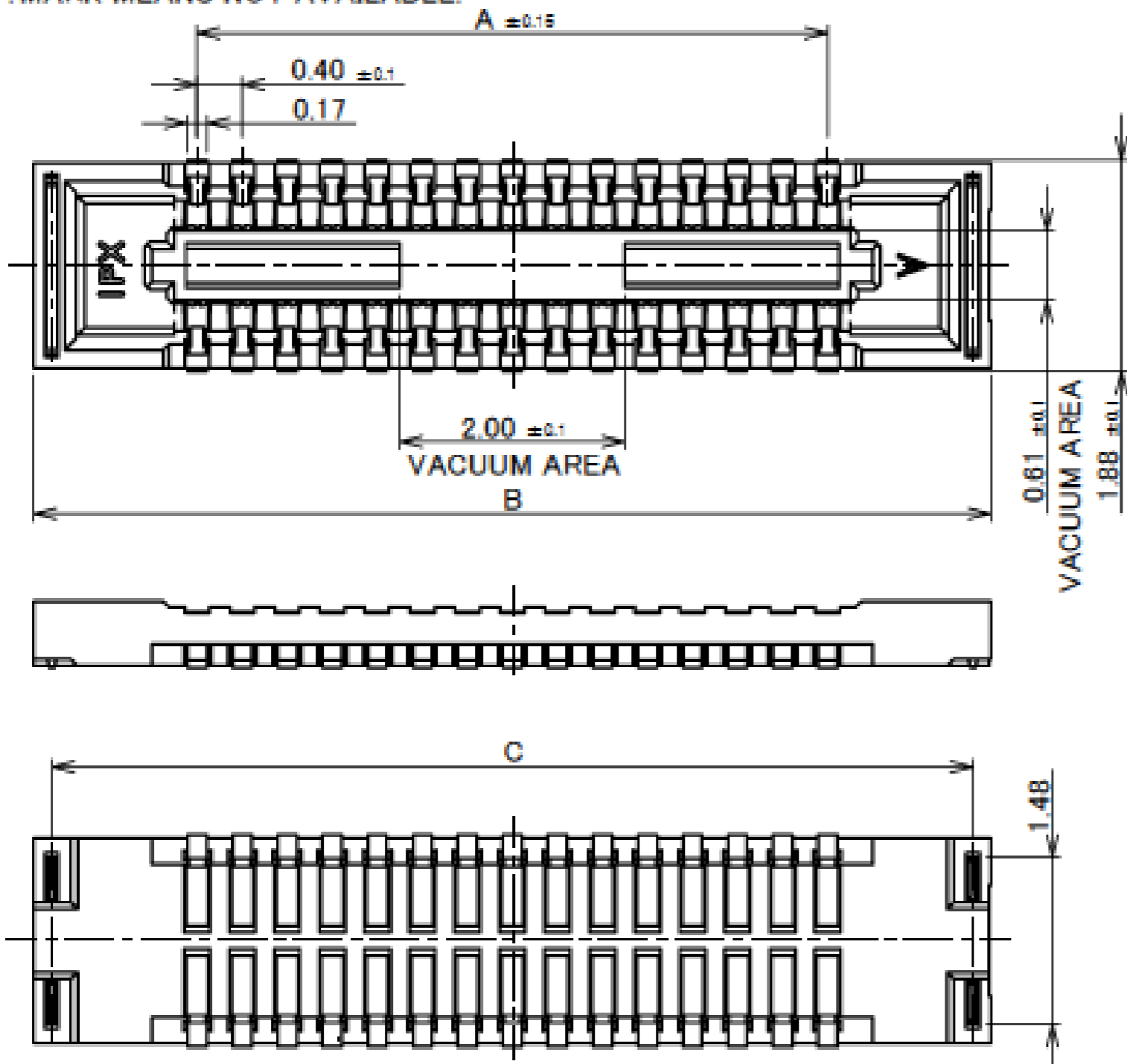
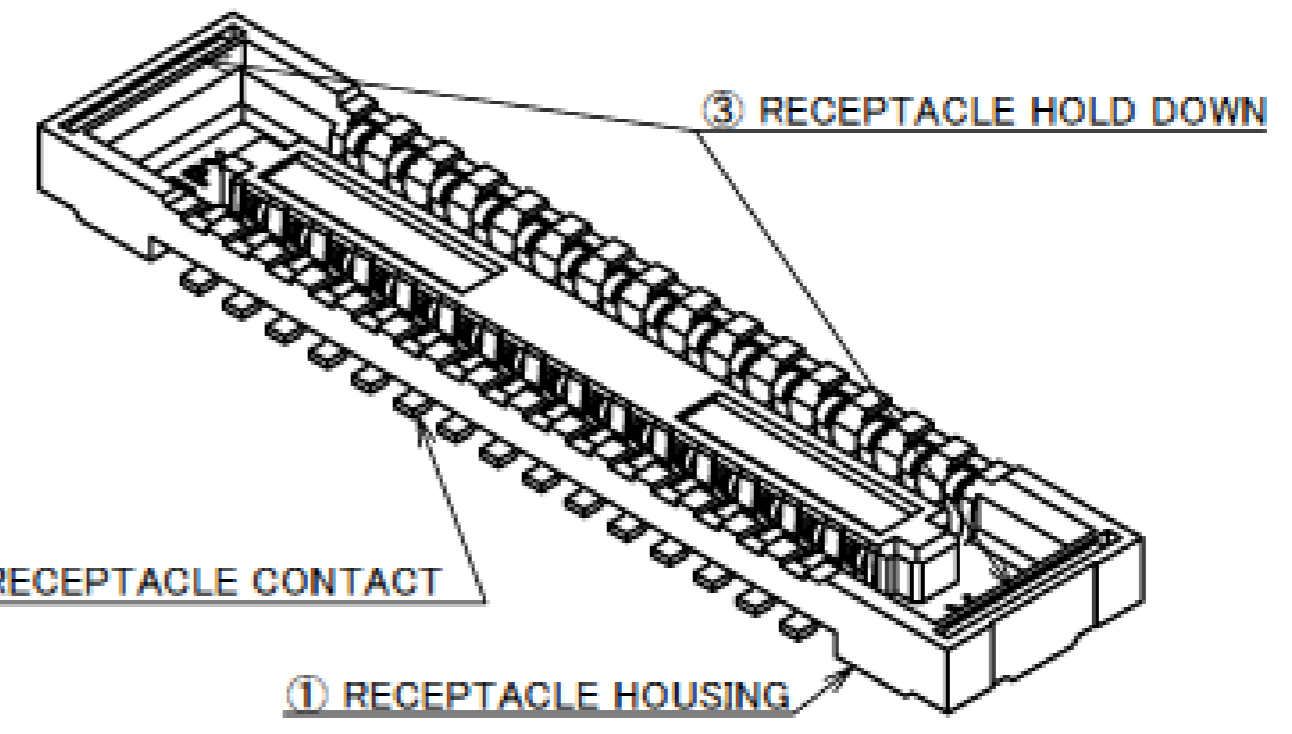
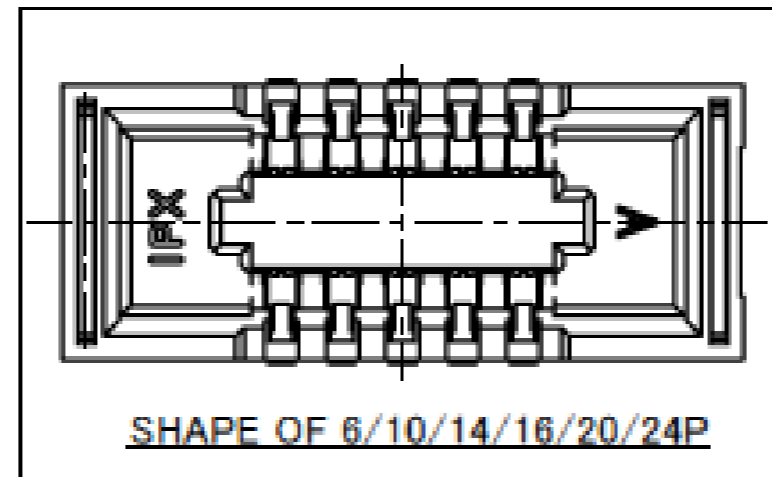
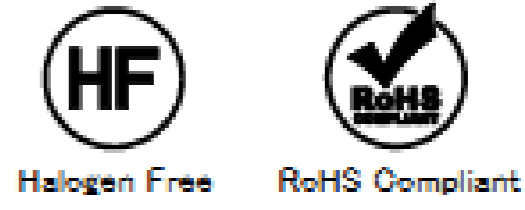

NO	DISCRIPTION	MATERIAL	FINISH , REMARKS
3	HOLD DOWN	BRASS	ALL OVER Ni 1.27 μm MIN. SOLDERING PART Au 0.02 μm MIN.
2	CONTACT	PHOSPHOR BRONZE	ALL OVER Ni 1.27 μm MIN. CONTACT PART Au 0.03 μm MIN. SOLDERING PART Au 0.02 μm MIN.
1	HOUSING	LCP	UL94V-0 BLACK

Rev.10

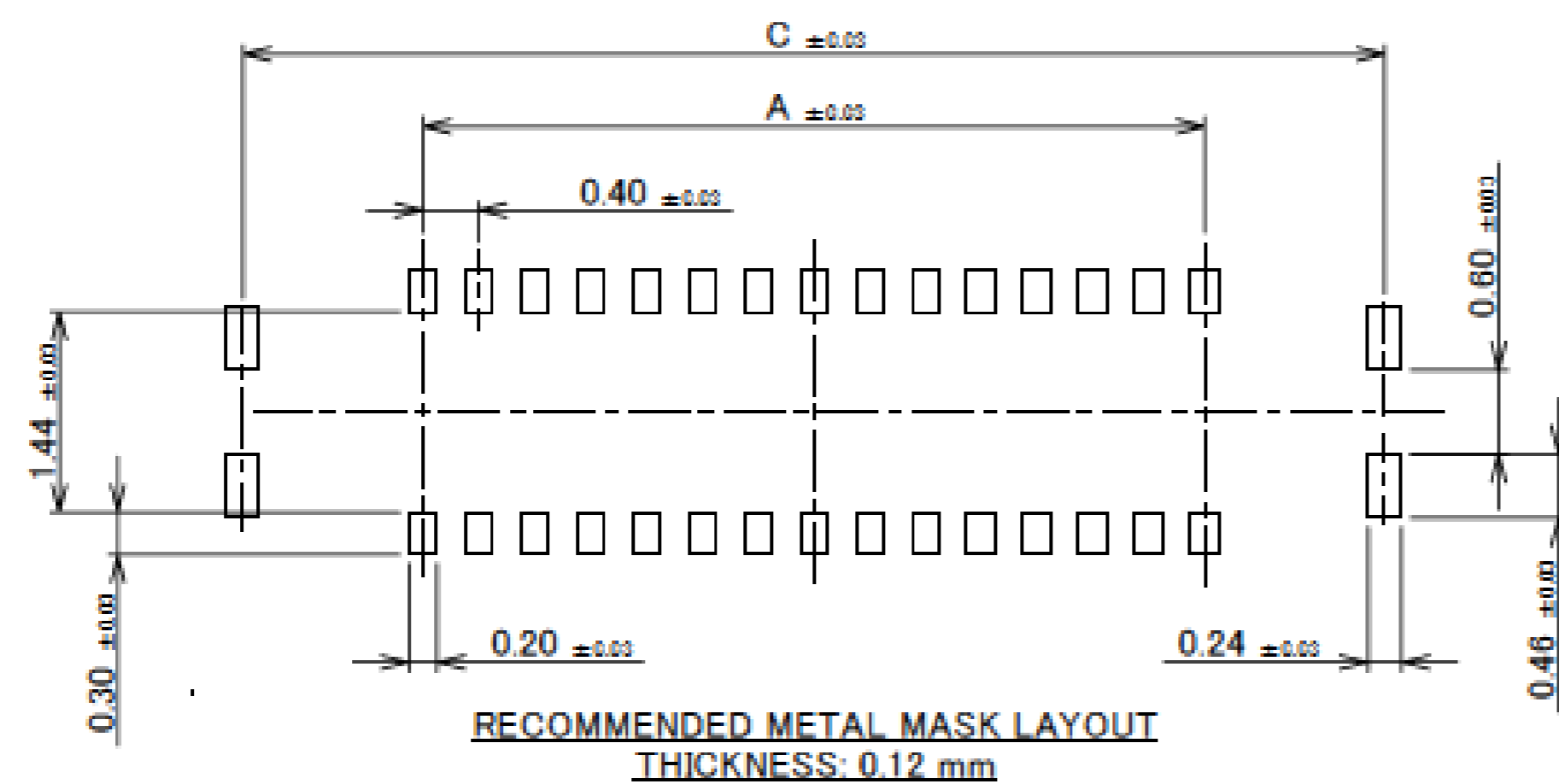
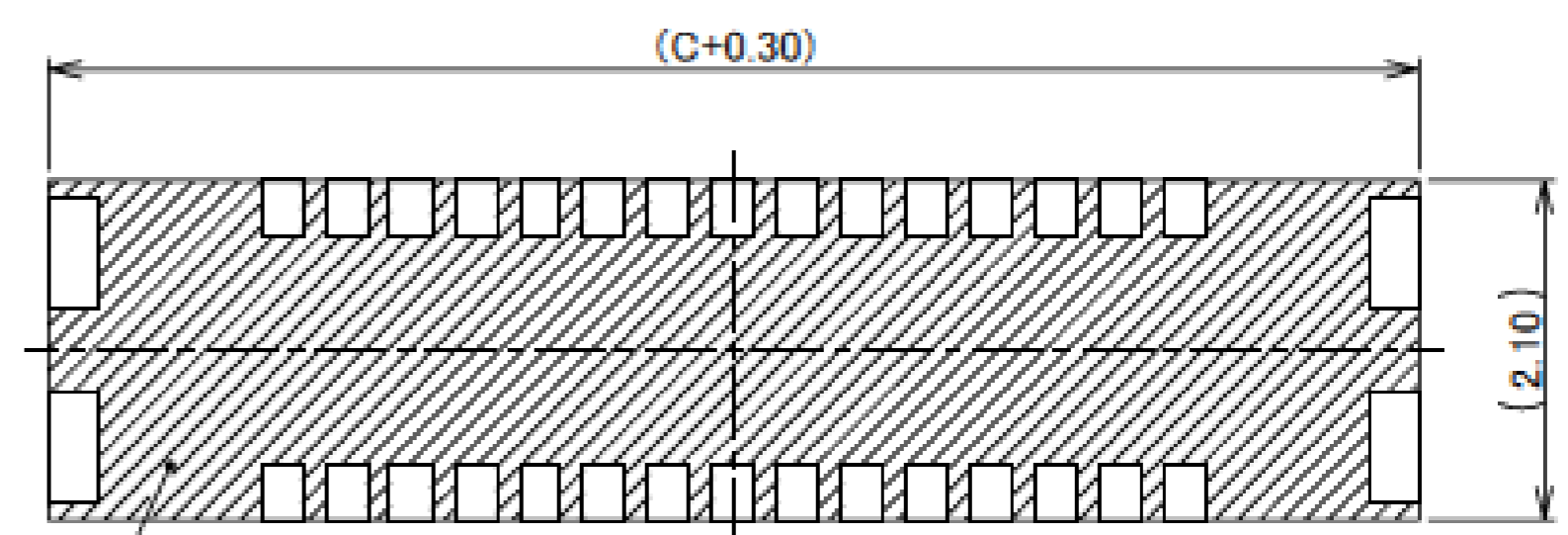
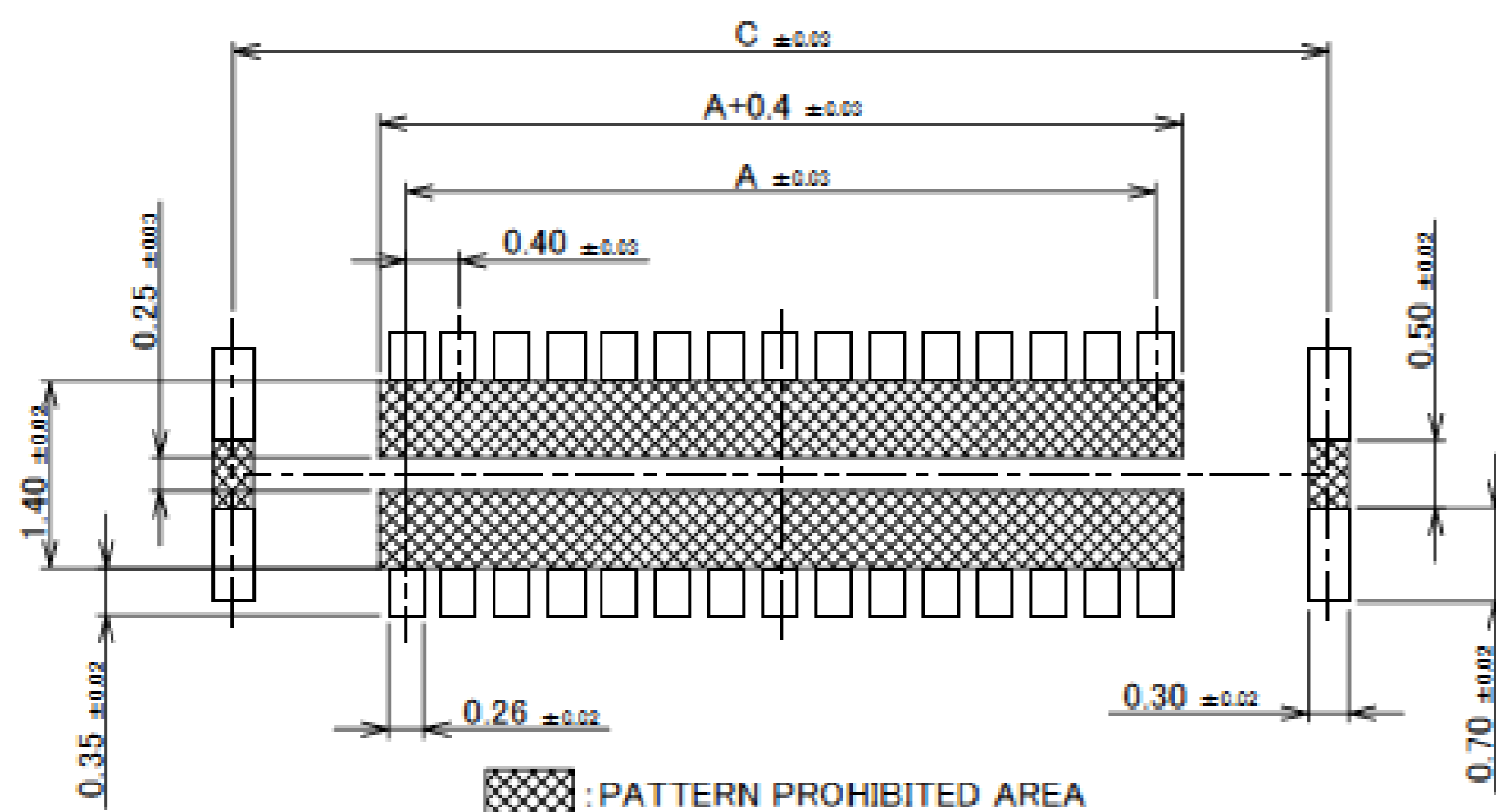

NOTES.
1. THIS AREA CANNOT MOUNT ANOTHER COMPONENTS.

Rev.10

Receptacle Assembly

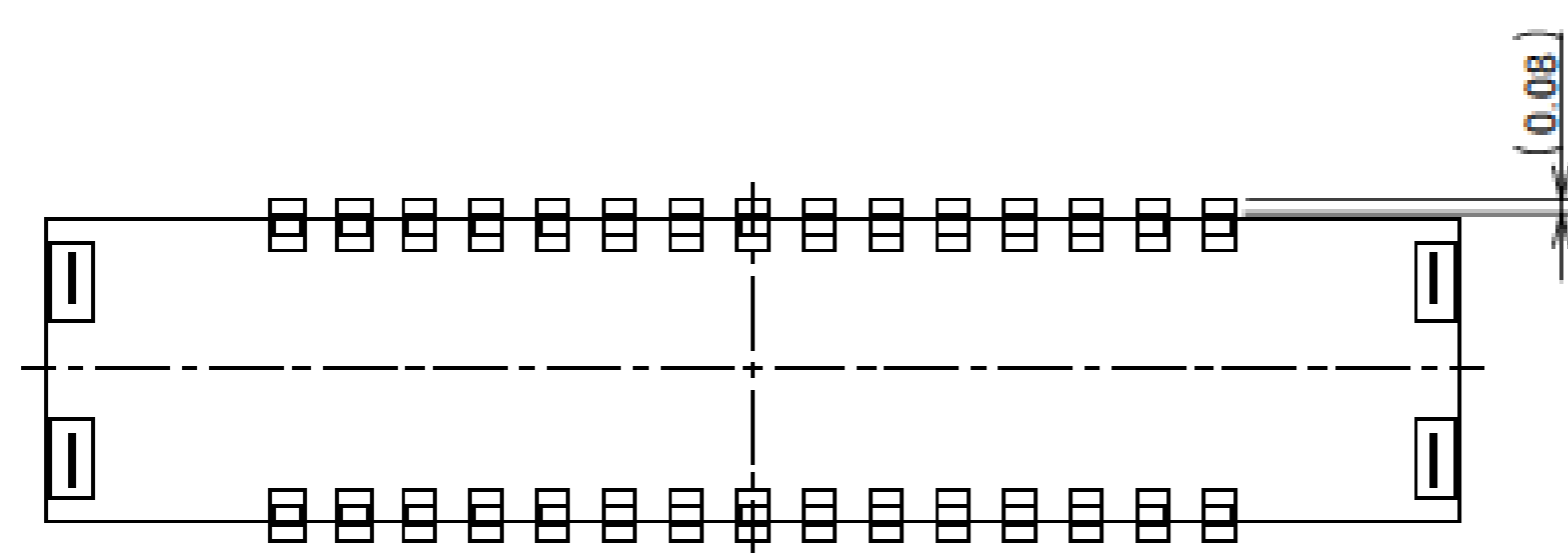

CONNECTOR ON RECOMMENDED FOOTPRINT PATTERN

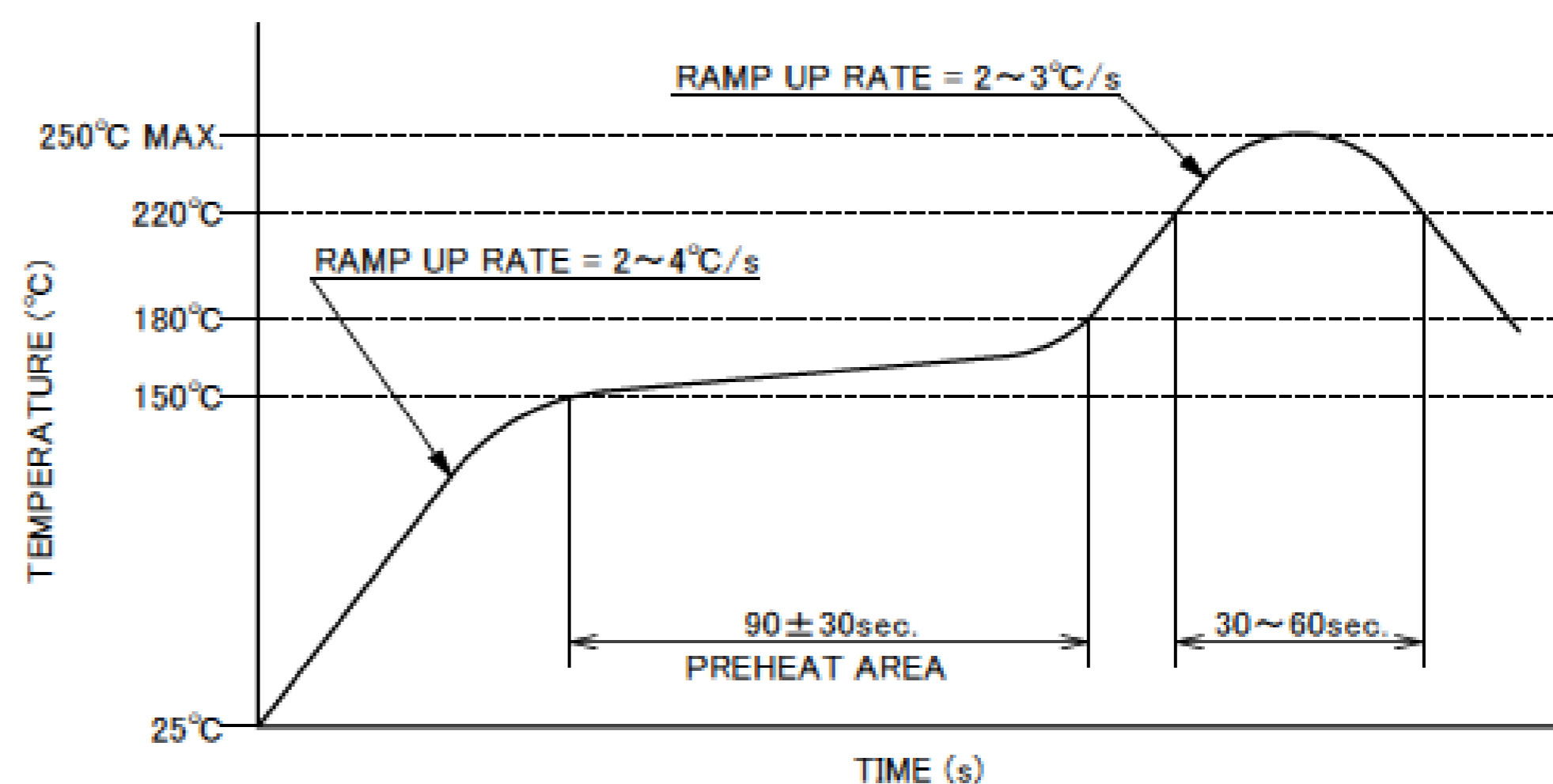

REFLOW TEMPERATURE PROFILE
SENJU METAL INDUSTRY CO., LTD. : M705-SHF(Sn96.5 Ag3.0 Cu0.5)

Rev.10

ITEMS	SPECIFICATION
APPLICABLE CONNECTOR PART No.	20641-0**E
RATING VOLTAGE	60V AC (PER CONTACT PIN)
RATING AMPERAGE (FOR SIGNAL CONTACT)	0.3A AC/DC (PER CONTACT PIN)
OPERATING TEMPERATURE	233~358K(-40°C~+85°C)
OPERATING HUMIDITY	85% MAX.(NON-CONDENSING)
CONTACT RESISTANCE (FOR SIGNAL CONTACT)	INITIAL : 80mohm MAX. / AFTER TEST : $\leq 120\text{mohm}$ MAX.
INSULATION RESISTANCE	INITIAL : 1,500Mohm MIN. / AFTER TEST : 500Mohm MIN.
DIELECTRIC WITHSTANDING VOLTAGE	AC250V 1min
DURABILITY	30 CYCLES
MATING FORCE (INITIAL)	6P : 10.0N MAX. 30P : 36.0N MAX. 10P : 12.0N MAX. 34P : 40.8N MAX. 24P : 28.8N MAX. 40P : 48.0N MAX.
UNMATING FORCE (AFTER TEST)	6P : 1.2N MIN. 30P : 6.0N MIN. 10P : 2.0N MIN. 34P : 6.8N MIN. 24P : 4.8N MIN. 40P : 8.0N MIN.
COPLANARITY	0.08 MAX.
PRODUCT SPECIFICATION	PRS-1998
TEST REPORT	TR-14088
PACKING STANDARD	PST-14061
INSTRUCTION MANUAL	HIM-14018
APPEARANCE CRITERIA No.	QLS-A***

Rev.10

Custom Connectors Available

 RF Connector

MHF® series



Micro-coaxial/Twinax/
Discrete Wire Connector



CABLINE® series



Optical Module

LIGHTPASS® series



NOVASTACK® series



Board-to-Board Connector

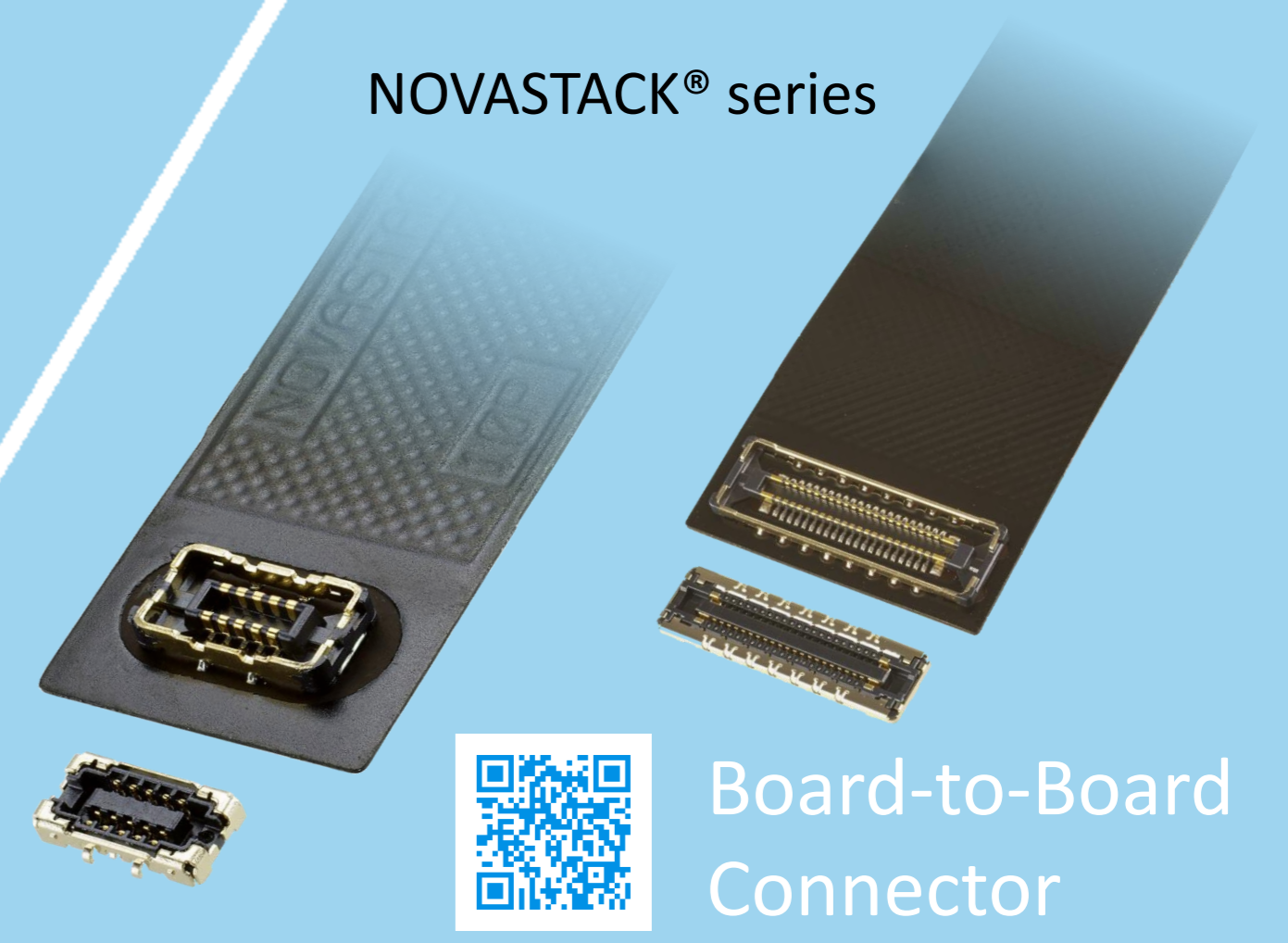

Power Connector/
Terminal

AP series

ISH® series



MINIFLEX® series

EVAFLEX® series



FPC FFC Connector



Inquiry



MINIDOCK® series



I/O Connector

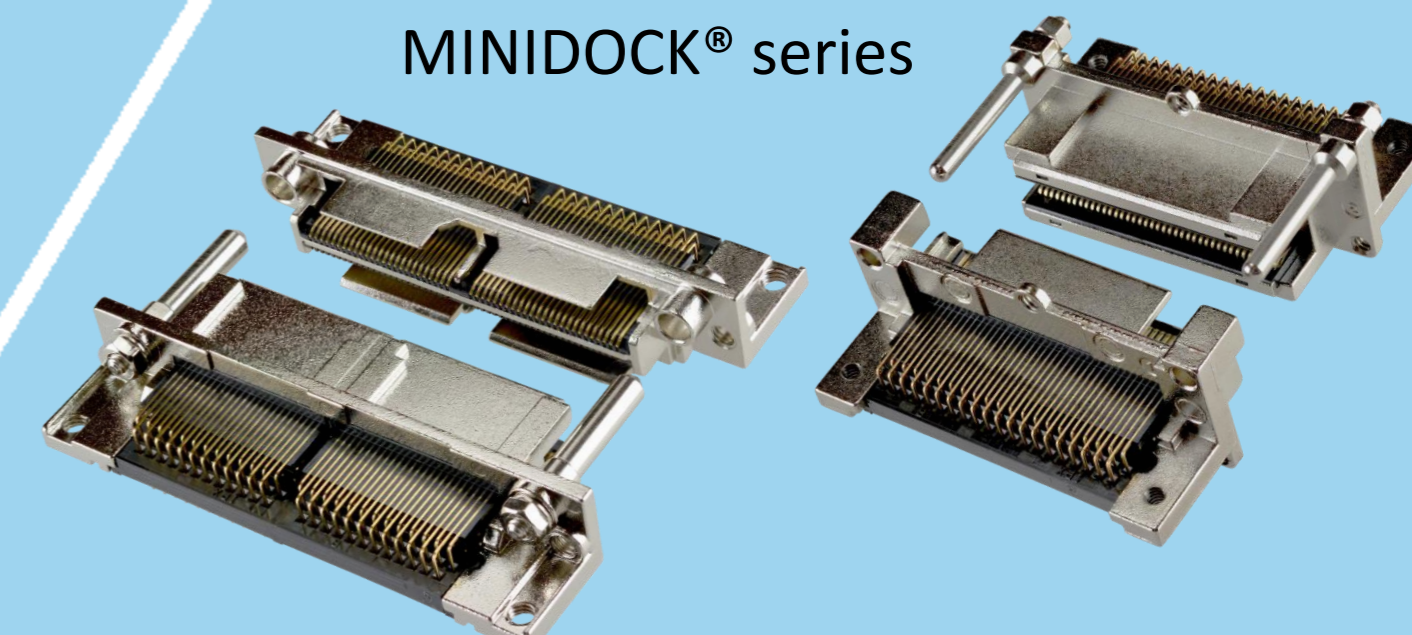

I-PEX, MHF, CABLINE, LIGHTPASS, NOVASTACK, ISH, IARPB, MINIFLEX, EVAFLEX, MINIDOCKS and ZenShield are registered trademarks of I-PEX Inc. Please note that the contents in the catalog might be changed without prior notification. I-PEX Inc. assumes no responsibility for any inaccuracies or obligation to update information on these documents. Please be sure to read and understand the latest "Precautions for Use" and "Instruction Manual" before you use our products. We shall not be responsible for any defects, damages or troubles in case you use our products without following the precautions for use. Please feel free to contact our sales representatives when you use our products for any applications that require very high reliability and safety, or that relate to human life (ex. nuclear power control, aerospace, transportation, medical equipment, safety equipment etc.).

Contact your sales representative or more detailed information.

www.i-pex.com



I-PEX

© I-PEX Inc. 2024
All rights reserved