

NOVASTACK® 35-HDP

支持高速传输 (20+ Gbps/lane) 全屏蔽构造, 带电源端子, 0.35 mm 间距, 高度: 0.7 mm

Product Specifications:

Board Pitch (mm)	0.35	
Wiping Length (mm)	Signal contact : 0.11, Power contact : 0.13	
Mated Size (mm)	Height	0.7 +/- 0.05
	Width	Formula: $4.89 + (0.35 * ?p/2)$
	Depth	3.7
Current Rating	Signal	0.3 A/pin
	Power	2.2 A/pin x 4
Pin Counts	Range	6 - 76 (signal) + 4 (power)
	Available	28,34,42,56,62 /+ 4

Applicable Standards (Reference Only):

USB4 (20 Gbps/lane) USB 3.1 Gen 2 (10 Gbps)
eDP HBR 3 (8.1 Gbps) eDP HBR 2 (5.4 Gbps)
HDMI 2.0 (6 Gbps) V-By-One HS 1.4 (4 Gbps)
MiPi standards

*如您需要了解未列出或不在范围内的Pin数, 请咨询我们。

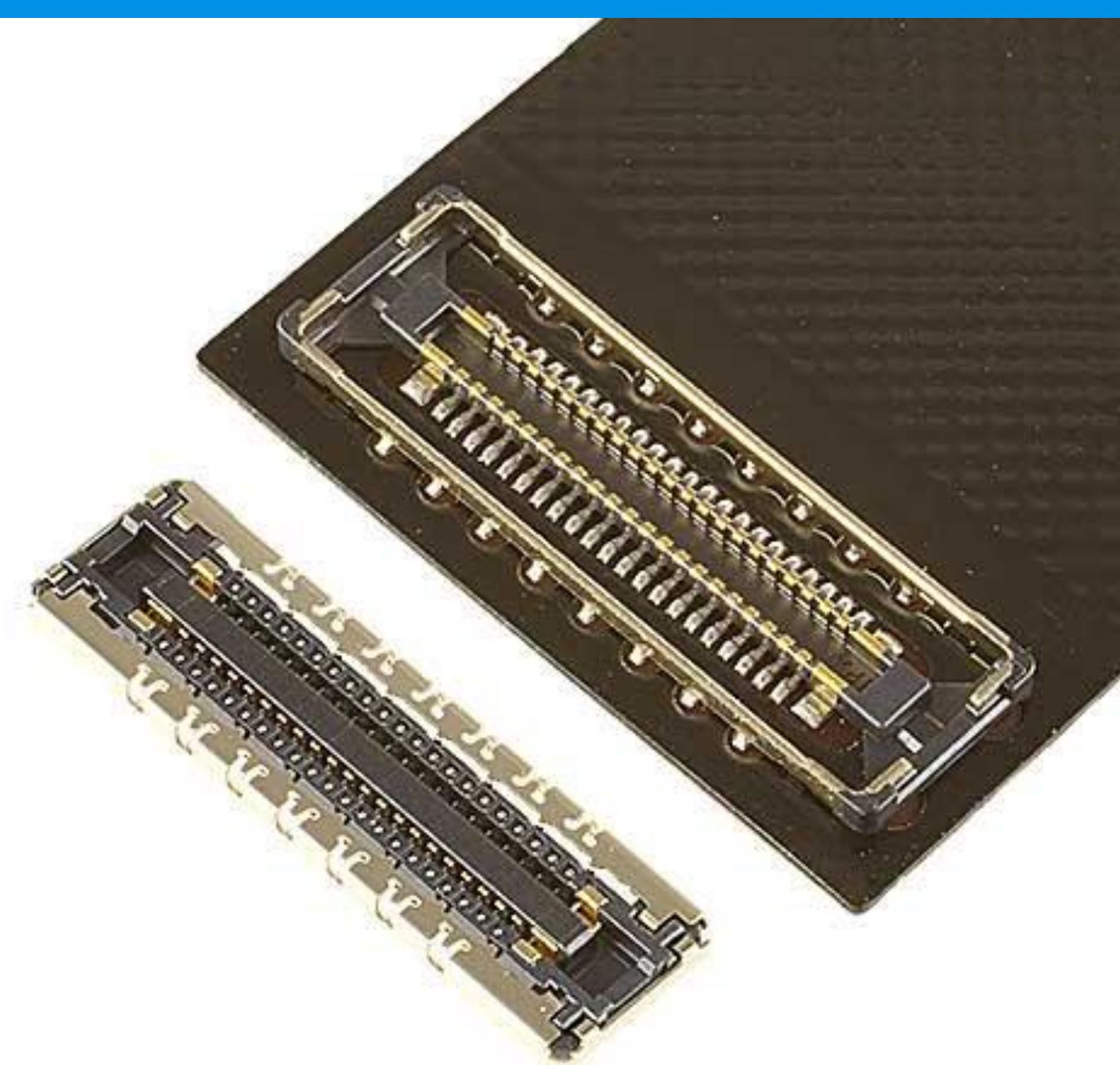

▶ ZenShield® 的全屏蔽设计和多点接地, 有效防止 EMI 外泄

○ Ground SMT points

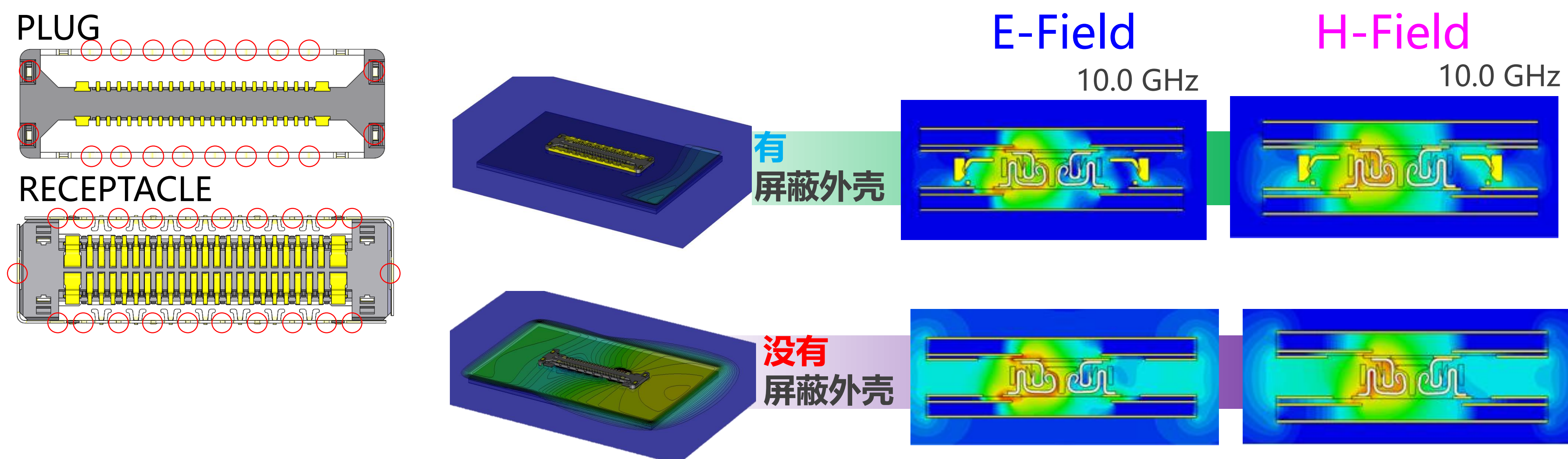

▶ 高速率传输, USB4 / Thunderbolt 4 (20+ Gbps / lane) 应用的理想之选

的眼图

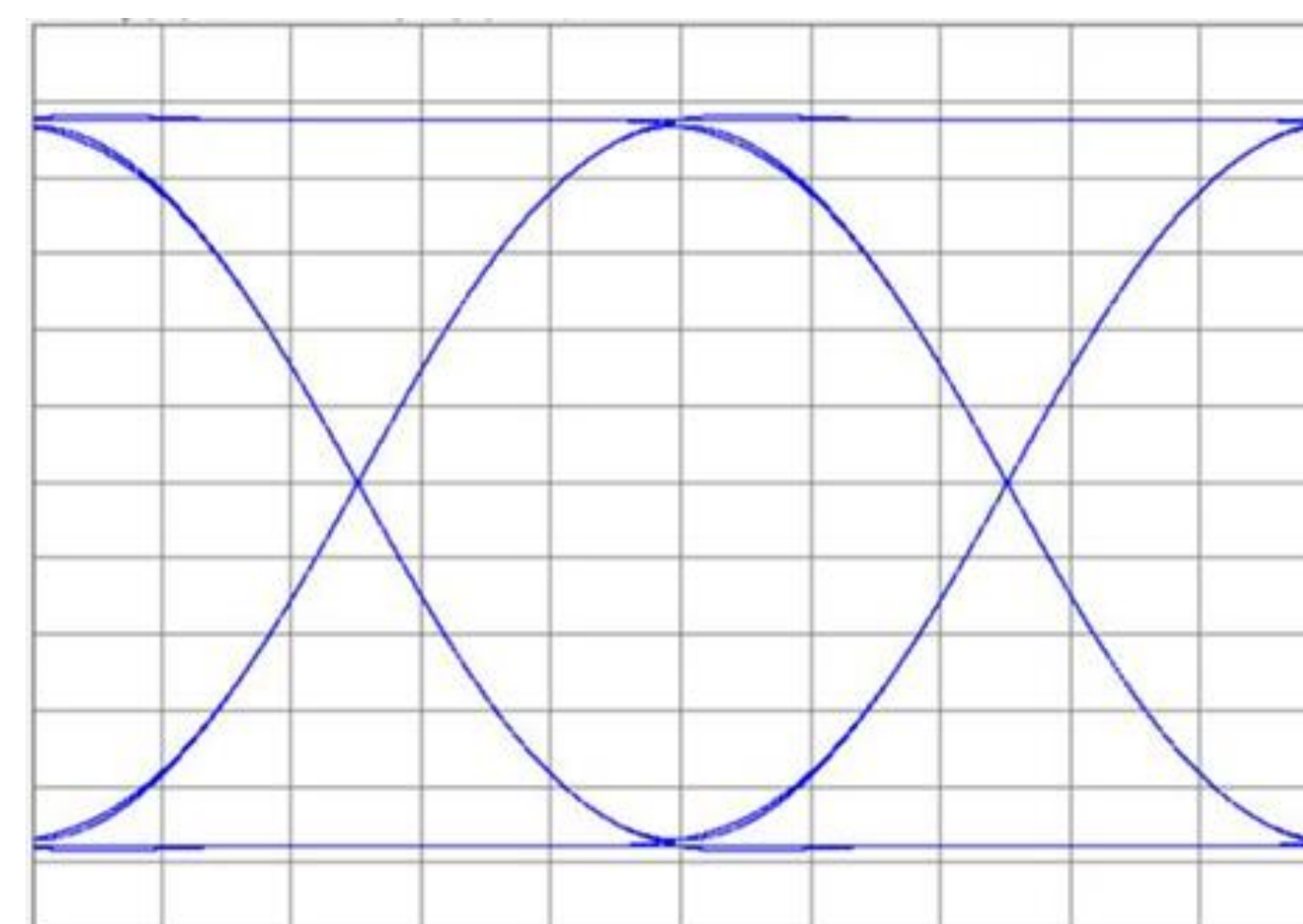
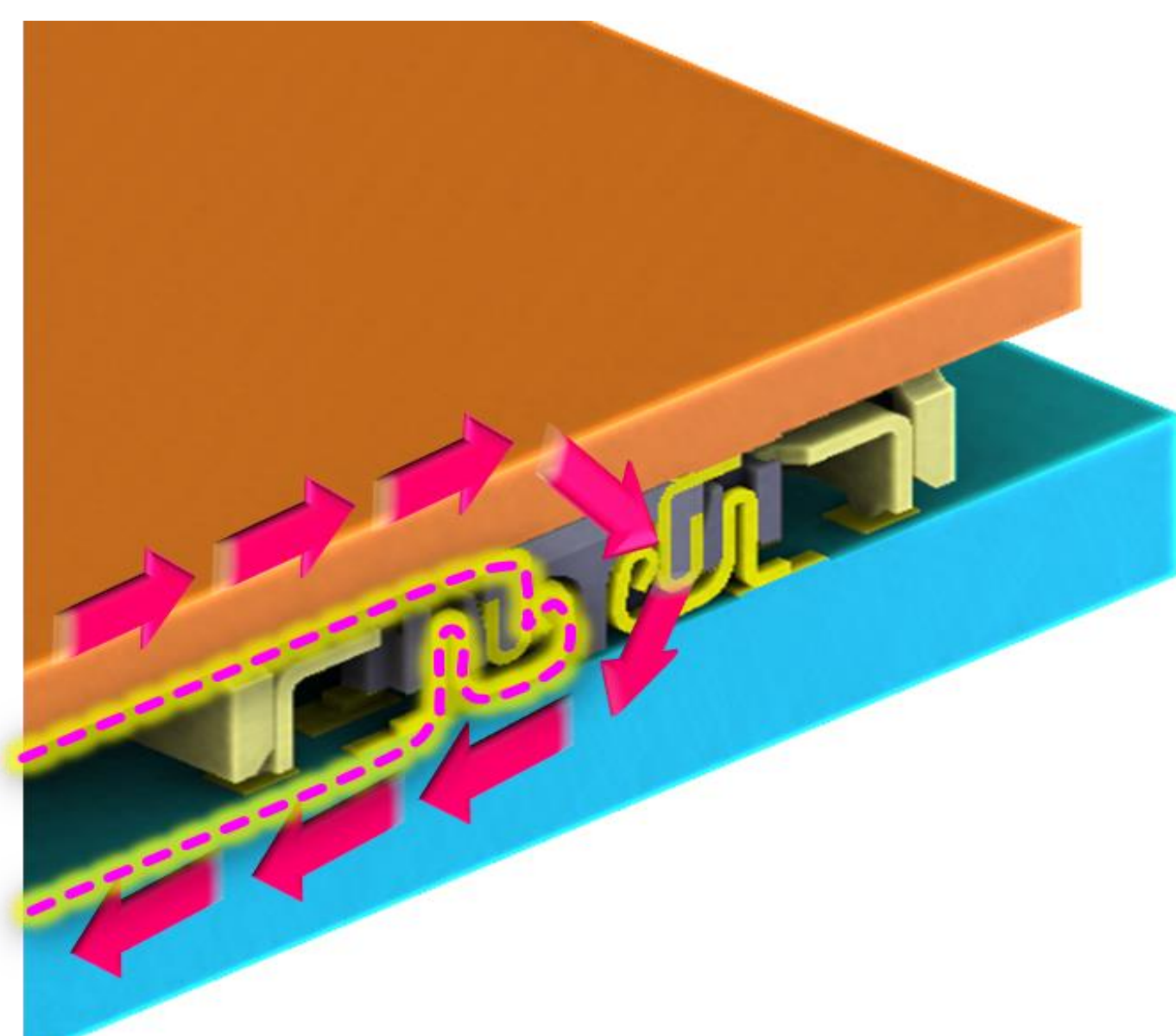

Bit rate : 25 Gbps
Rise time : 20 ps (10-90 %)
Input voltage : 800 mVp-p

*Please contact I-PEX for more test details.

▶ 电源端子支持大电流传输, 2.2 A/Pin x 4

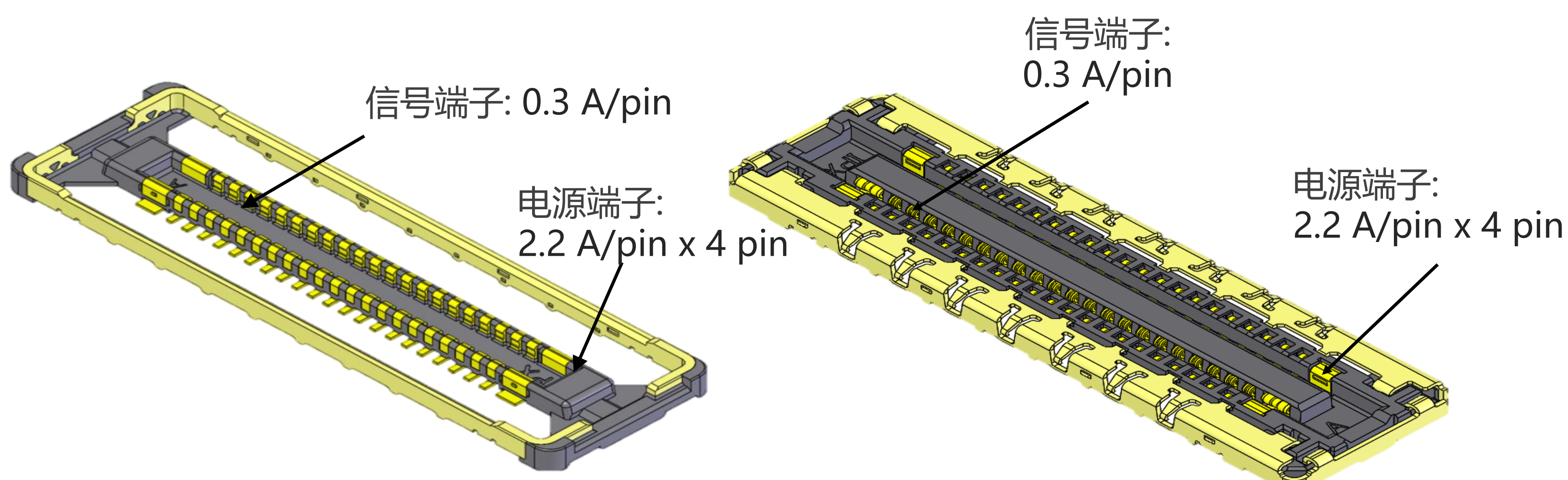

Component Parts Detail

Plug Assembly

Recommended P/N		20697-0**E-01#						
PART No.	SIGNAL POS.	POWER POS.	A	B	C	D	E	
20697-028E-01	28P	4P	9.79	7.99	5.60	4.55	9.19	
20697-034E-01	34P	4P	10.84	9.04	6.65	5.60	10.24	
20697-042E-01#	42P	4P	12.24	10.44	8.05	7.00	11.64	
20697-056E-01#	56P	4P	14.69	12.89	10.50	9.45	14.09	
20697-062E-01#	62P	4P	15.74	13.94	11.55	10.50	15.14	

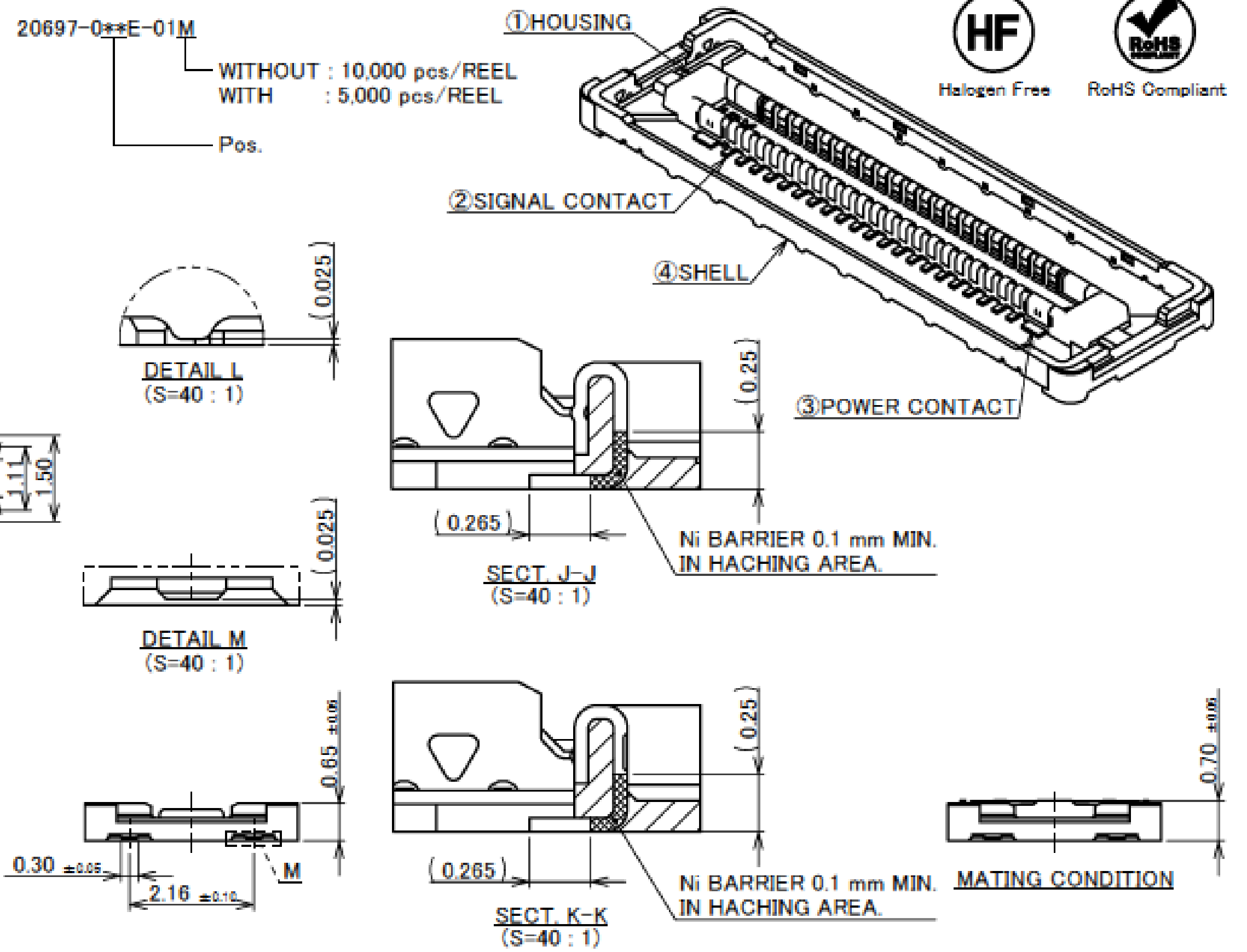
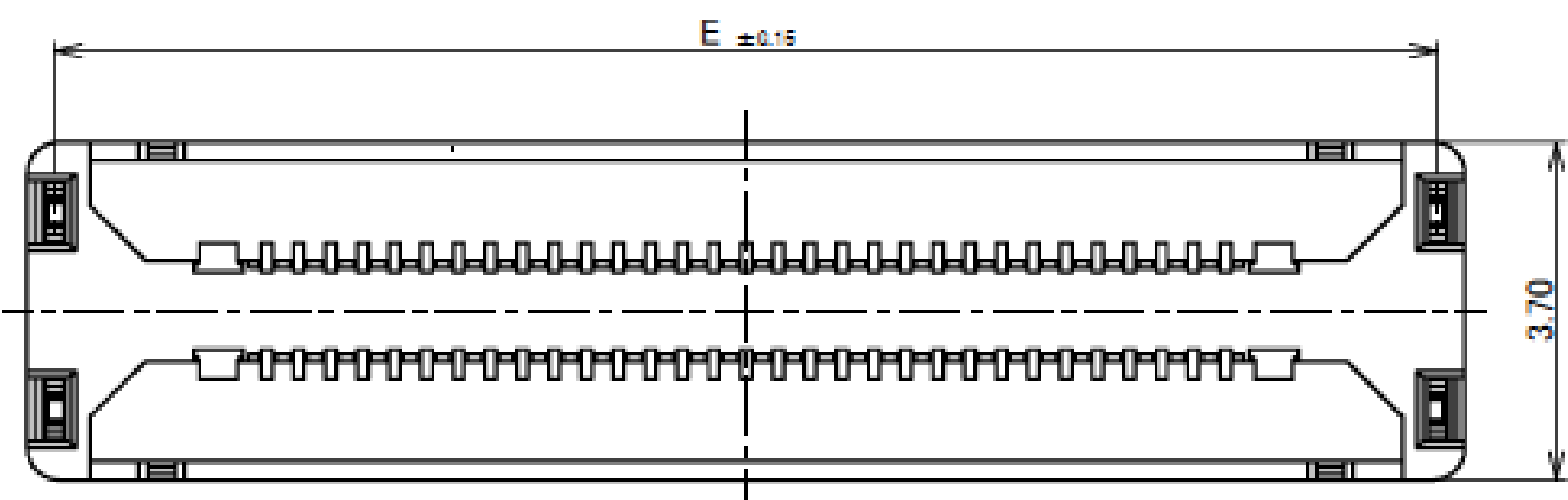
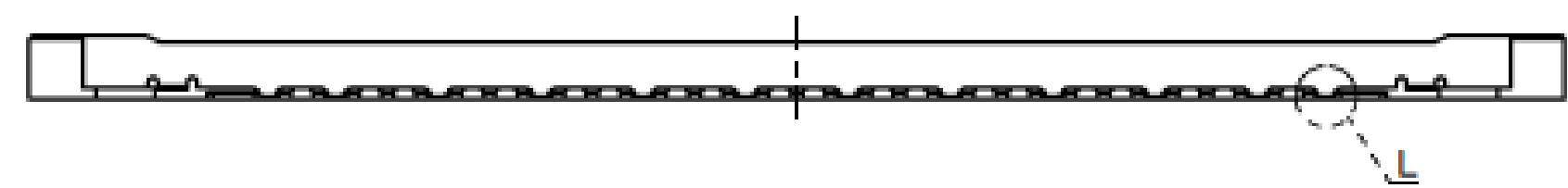
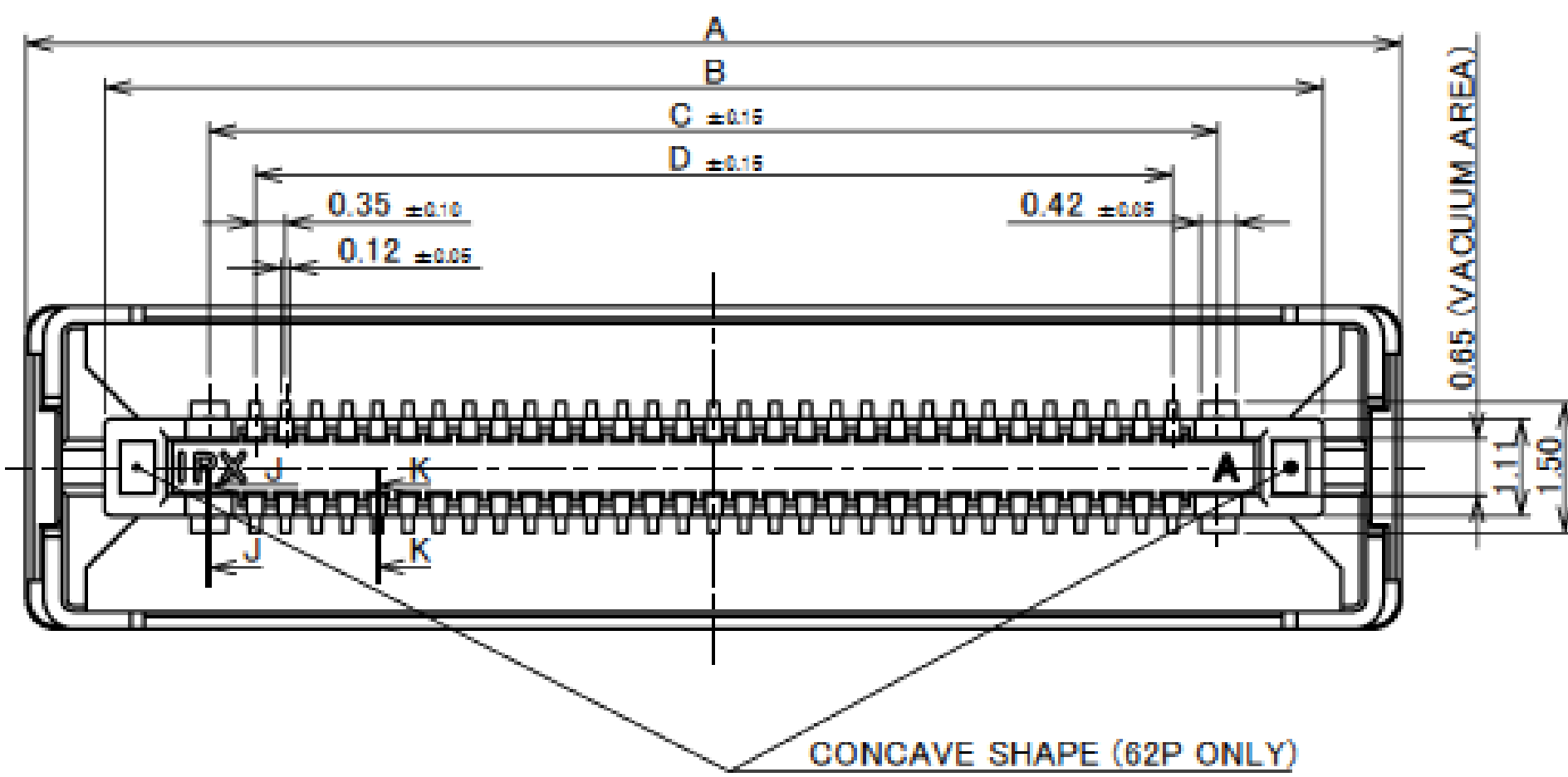

NO.	DISCRIPTION	MATERIAL	FINISH, REMARKS
4	SHELL	PHOSPHOR BRONZE	ALL OVER Ni 1.27 μ m MIN. Au 0.01 μ m MIN.
3	POWER CONTACT	CORSON ALLOY	ALL OVER Ni 1.27 μ m MIN. CONTACT PART Au 0.05 μ m MIN. SOLDERING PART Au 0.02 μ m MIN.
2	SIGNAL CONTACT	CORSON ALLOY	ALL OVER Ni 1.27 μ m MIN. CONTACT PART Au 0.05 μ m MIN. SOLDERING PART Au 0.02 μ m MIN.
1	HOUSING	LCP	UL94V-0, BLACK

Plug Assembly

PART No.	SIGNAL POS.	POWER POS.
20697-028E-01	28P	4P
20697-034E-01	34P	4P
20697-042E-01#	42P	4P
20697-056E-01#	56P	4P
20697-062E-01#	62P	4P

20697-0**E-01M
 WITHOUT : 10,000 pcs/REEL
 WITH : 5,000 pcs/REEL
 Pos.

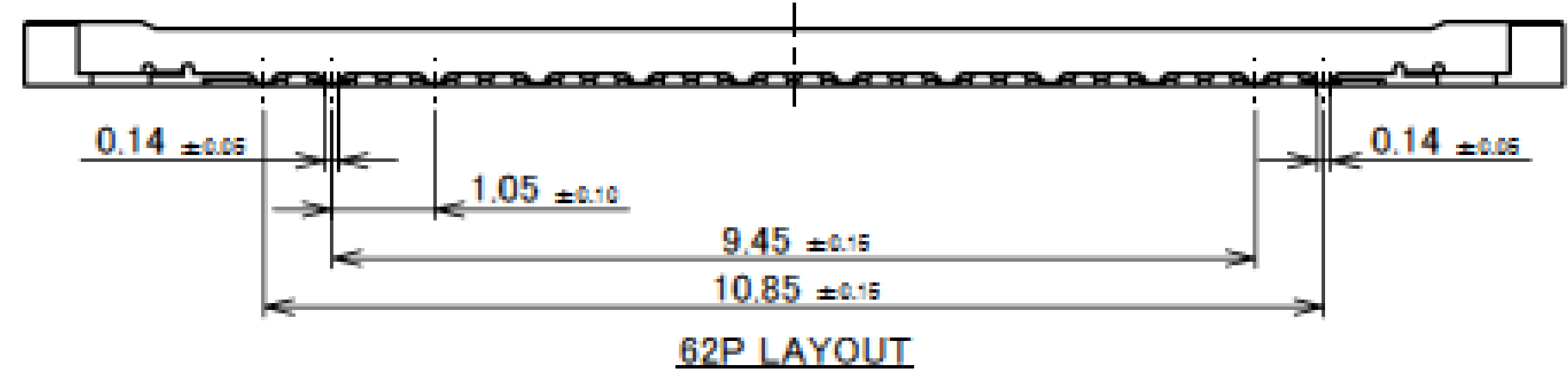
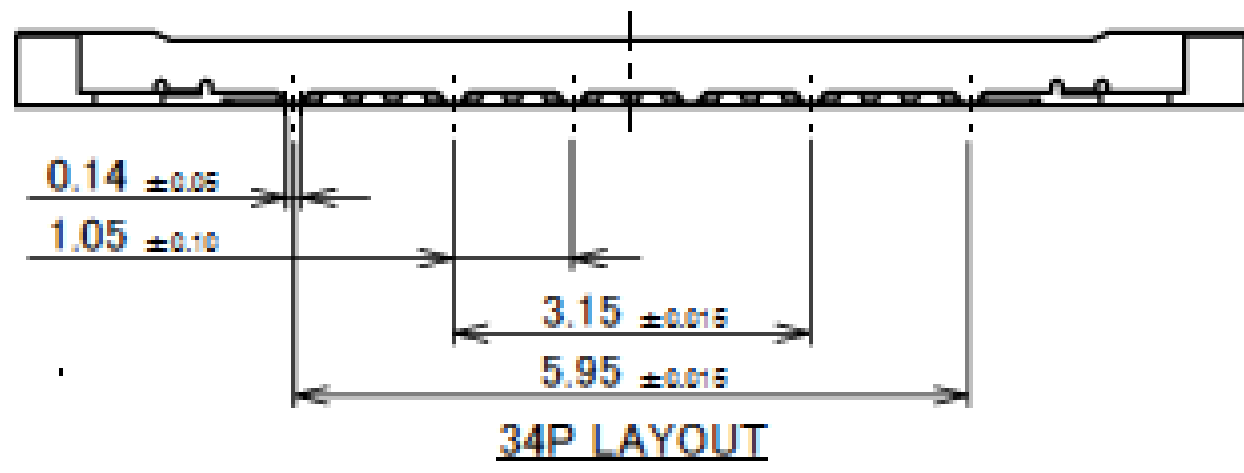
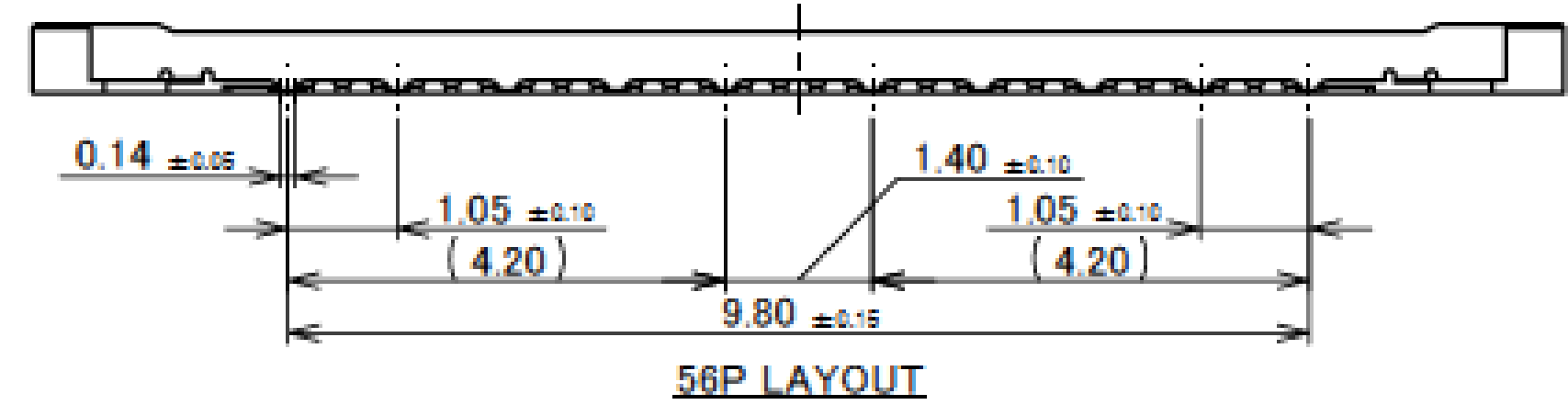
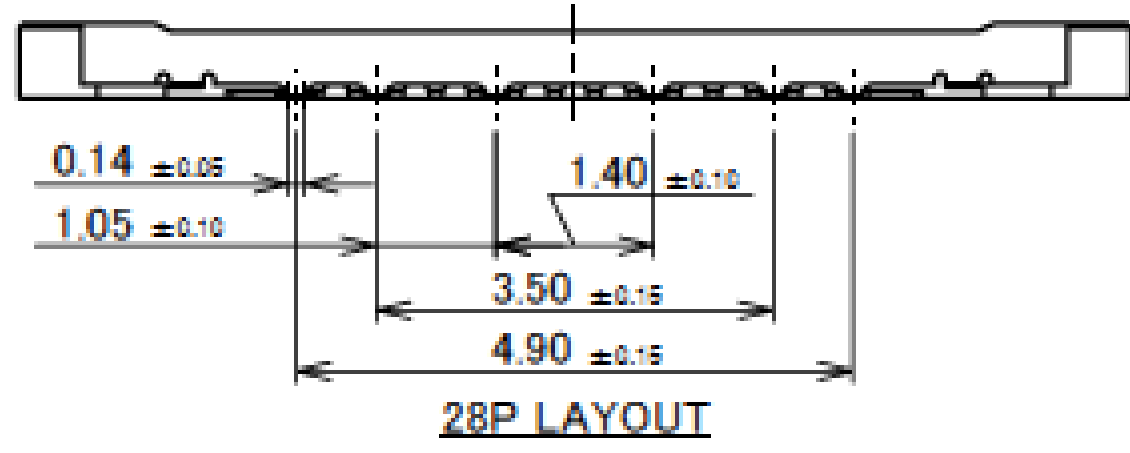
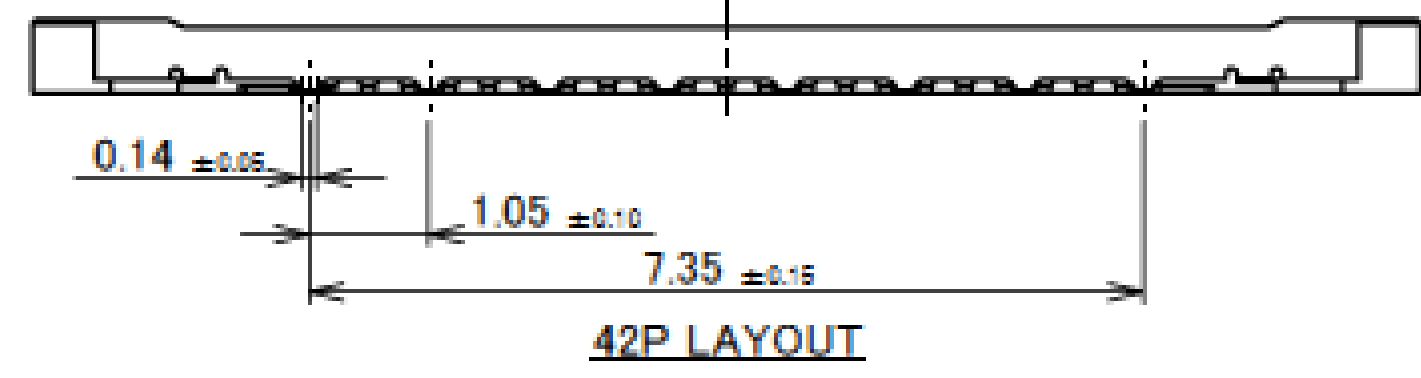

Rev.7

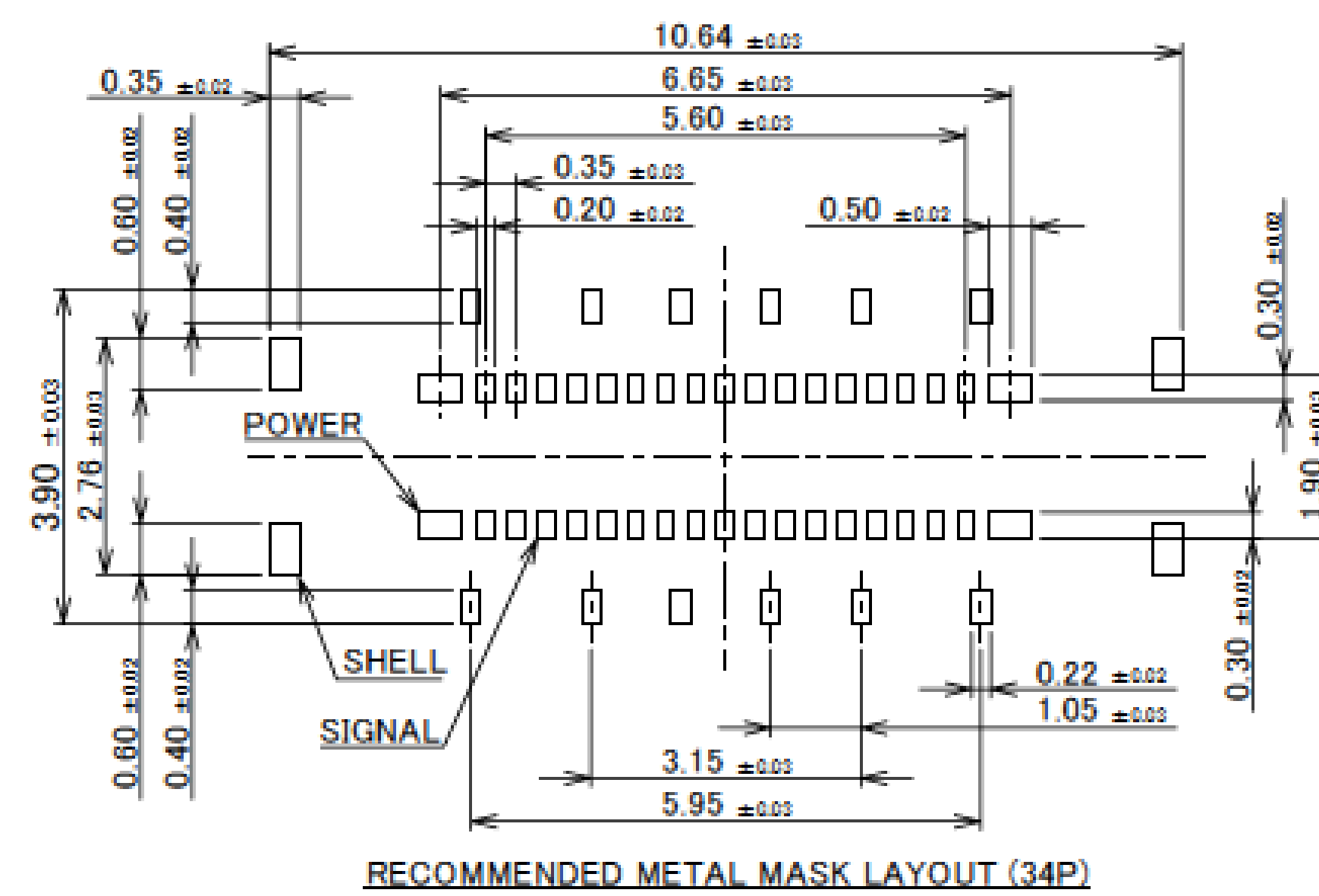
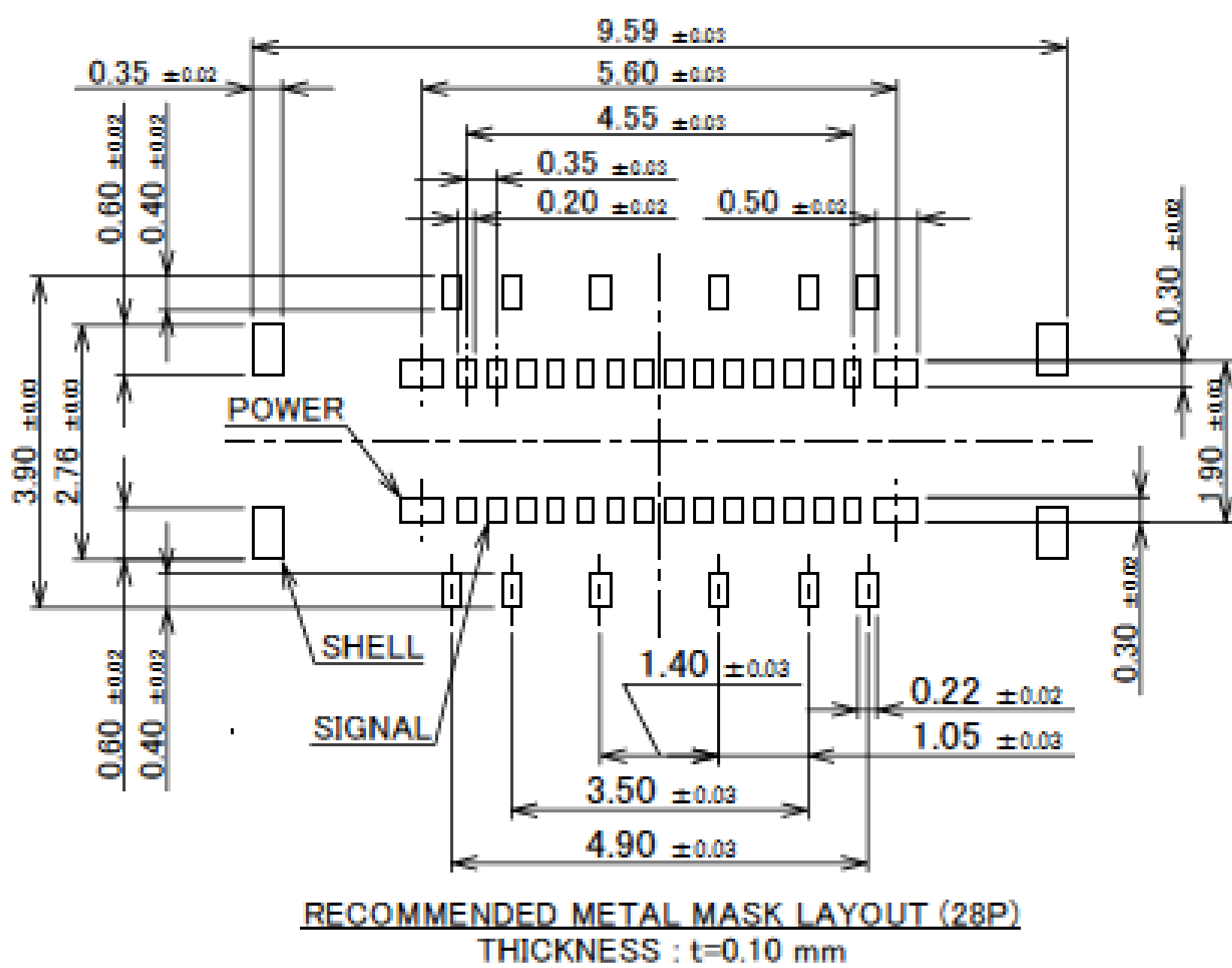
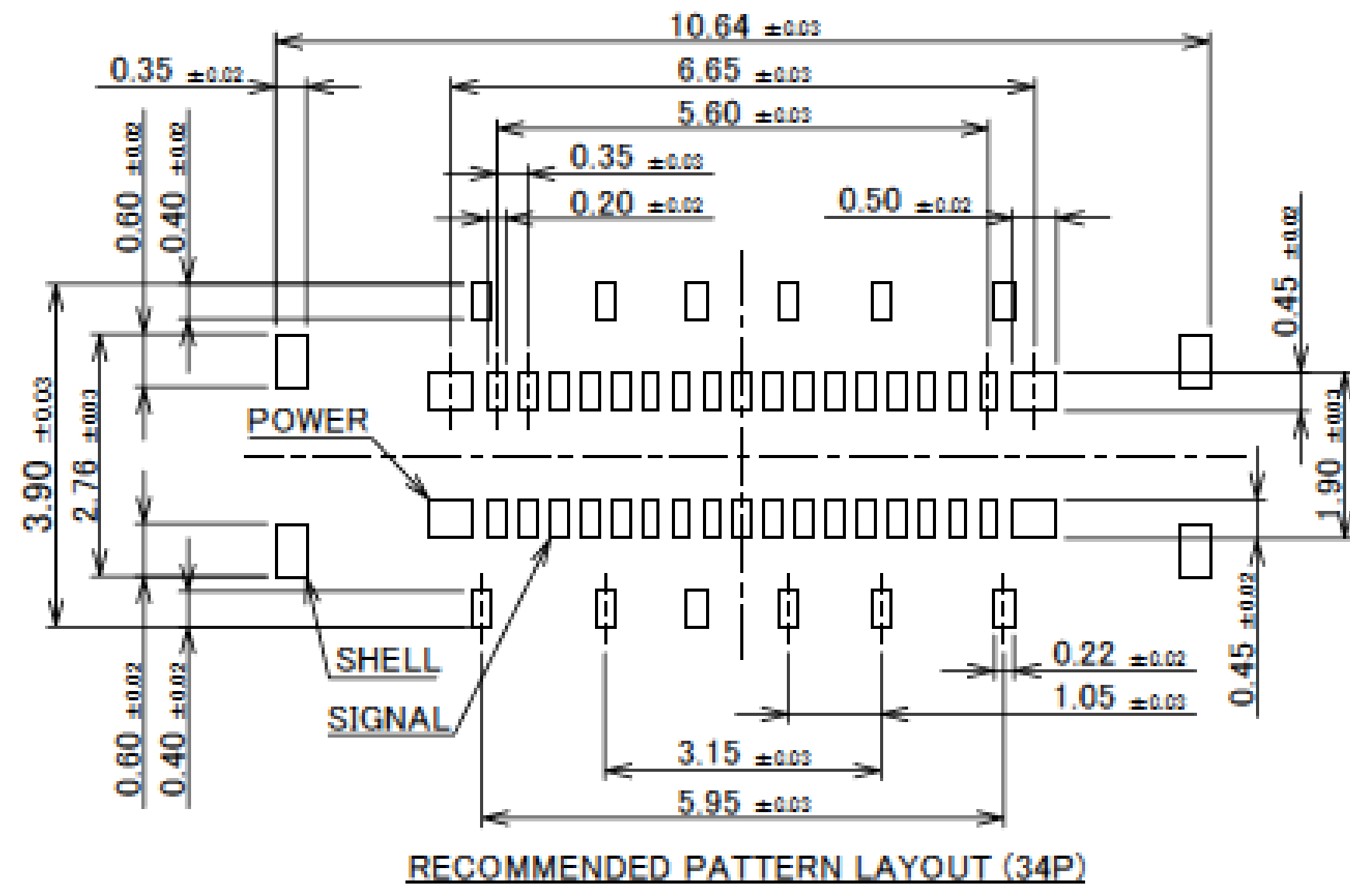
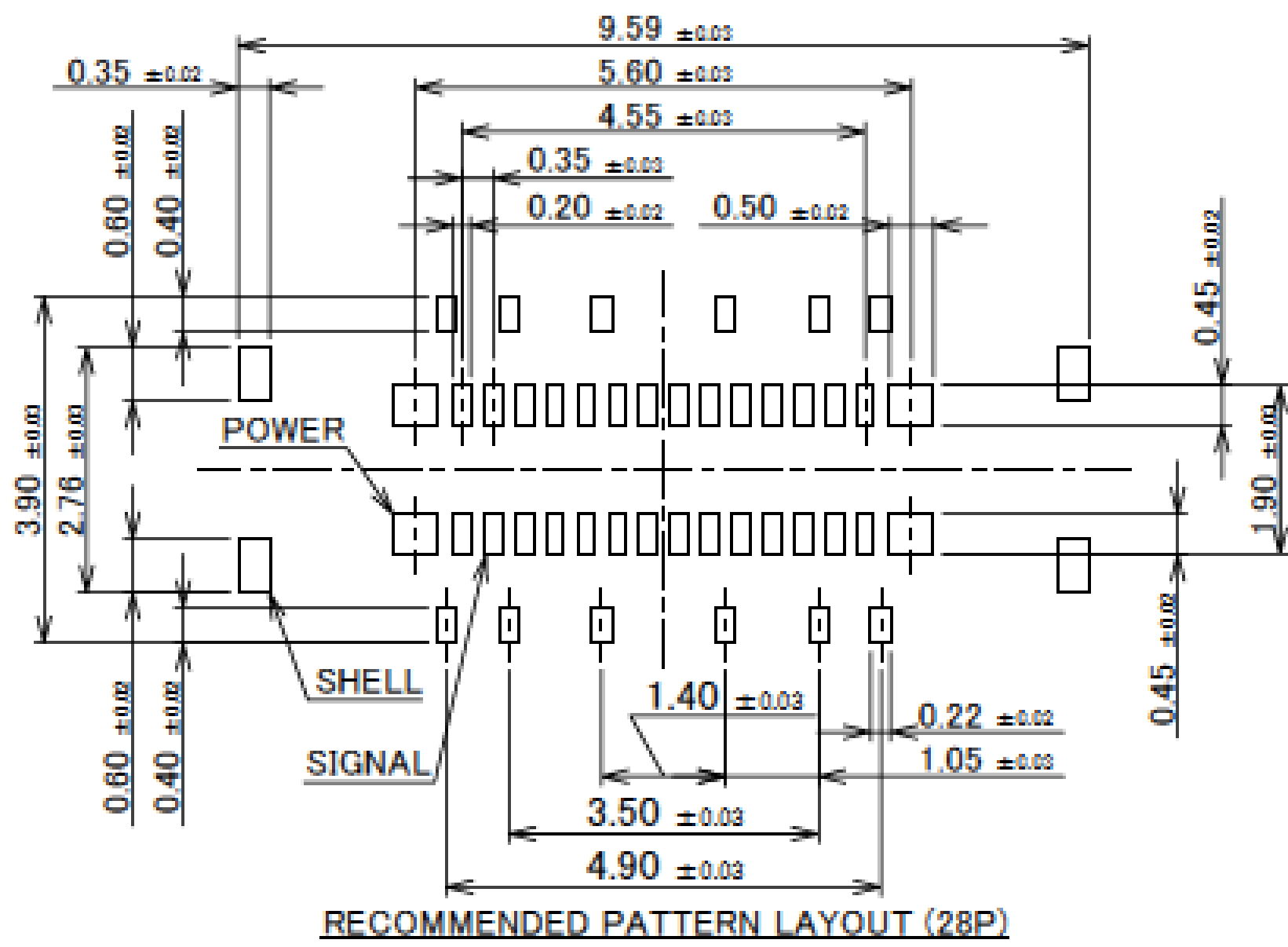

Rev.7

Plug Assembly

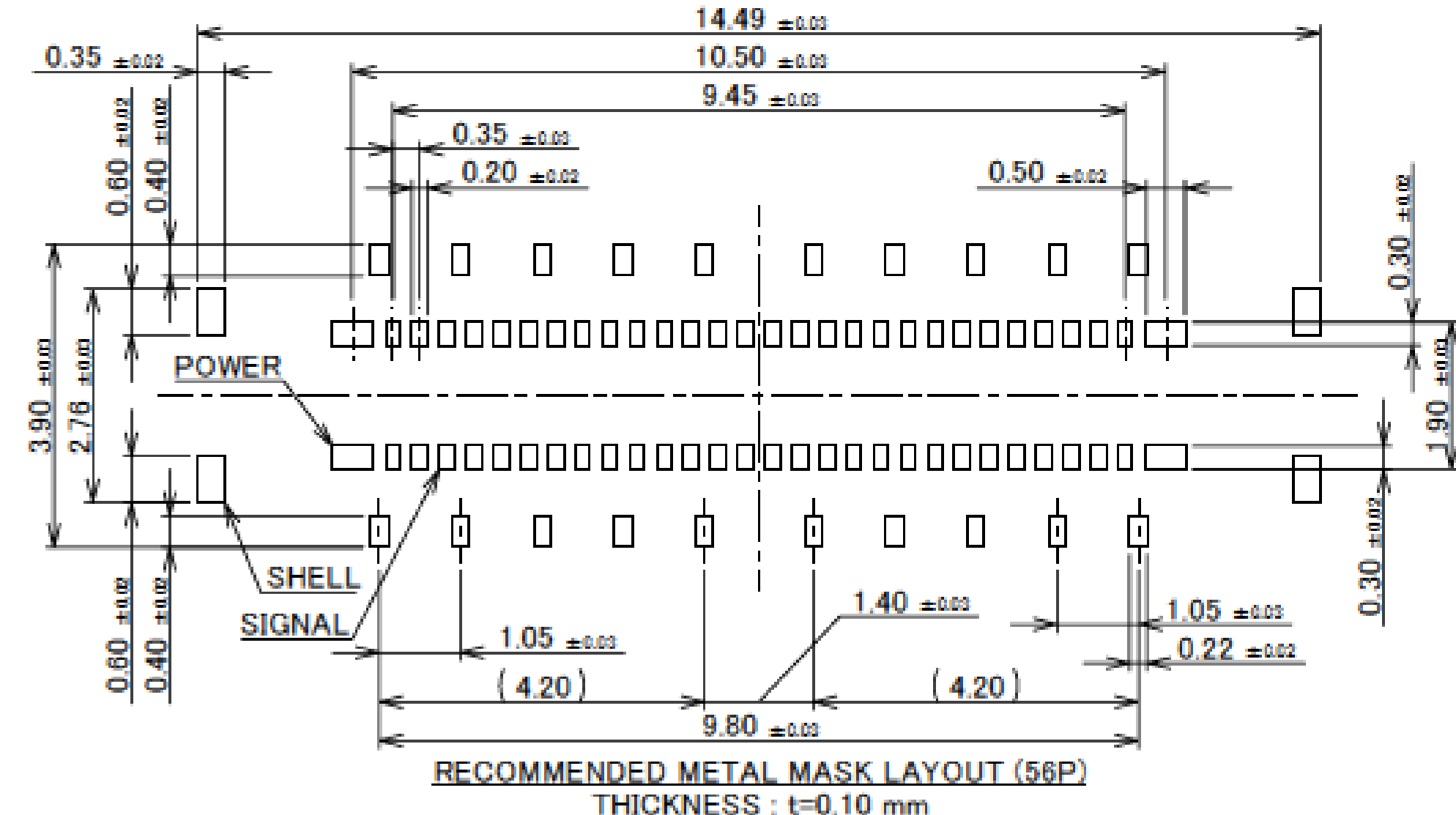
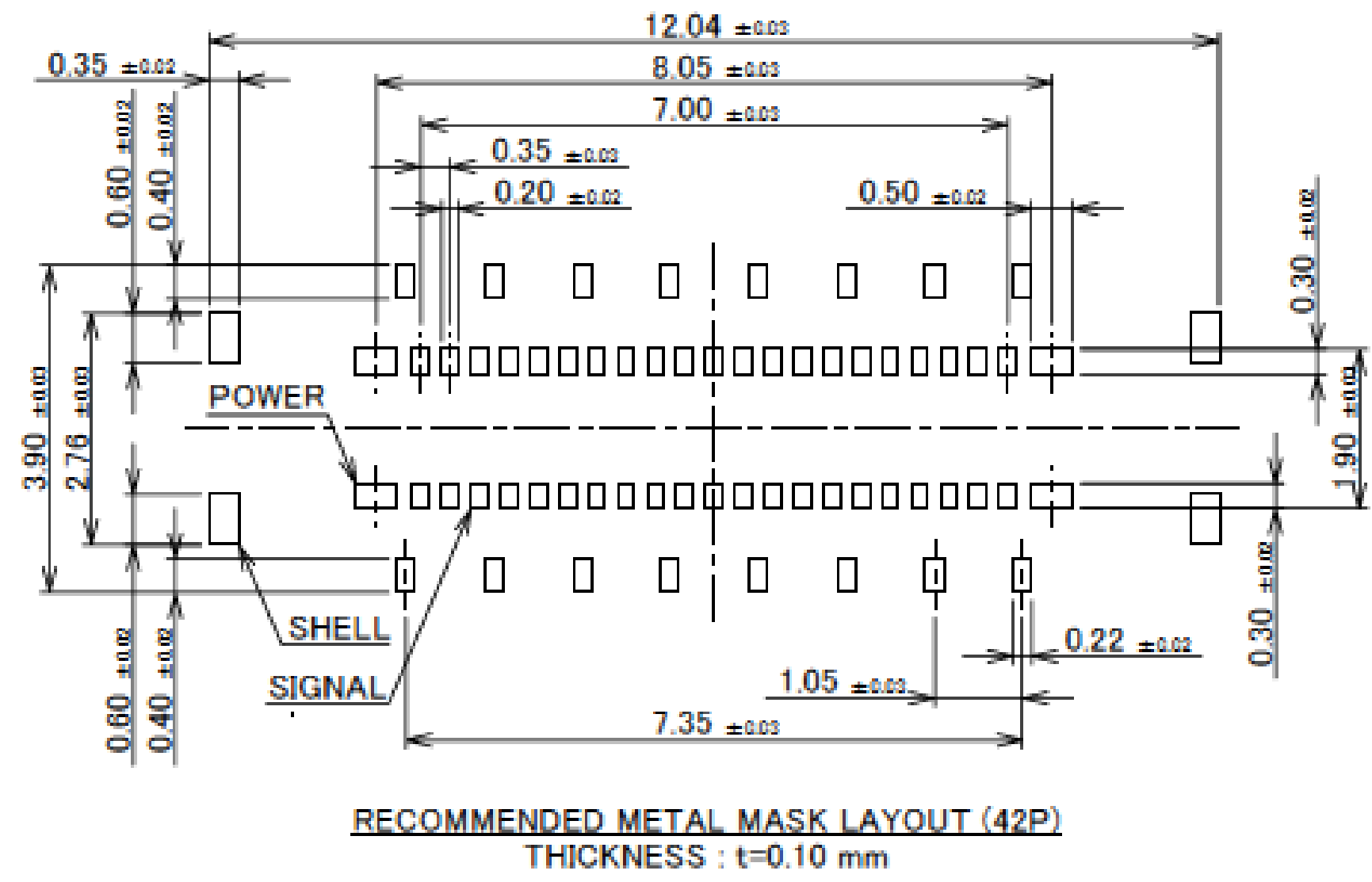
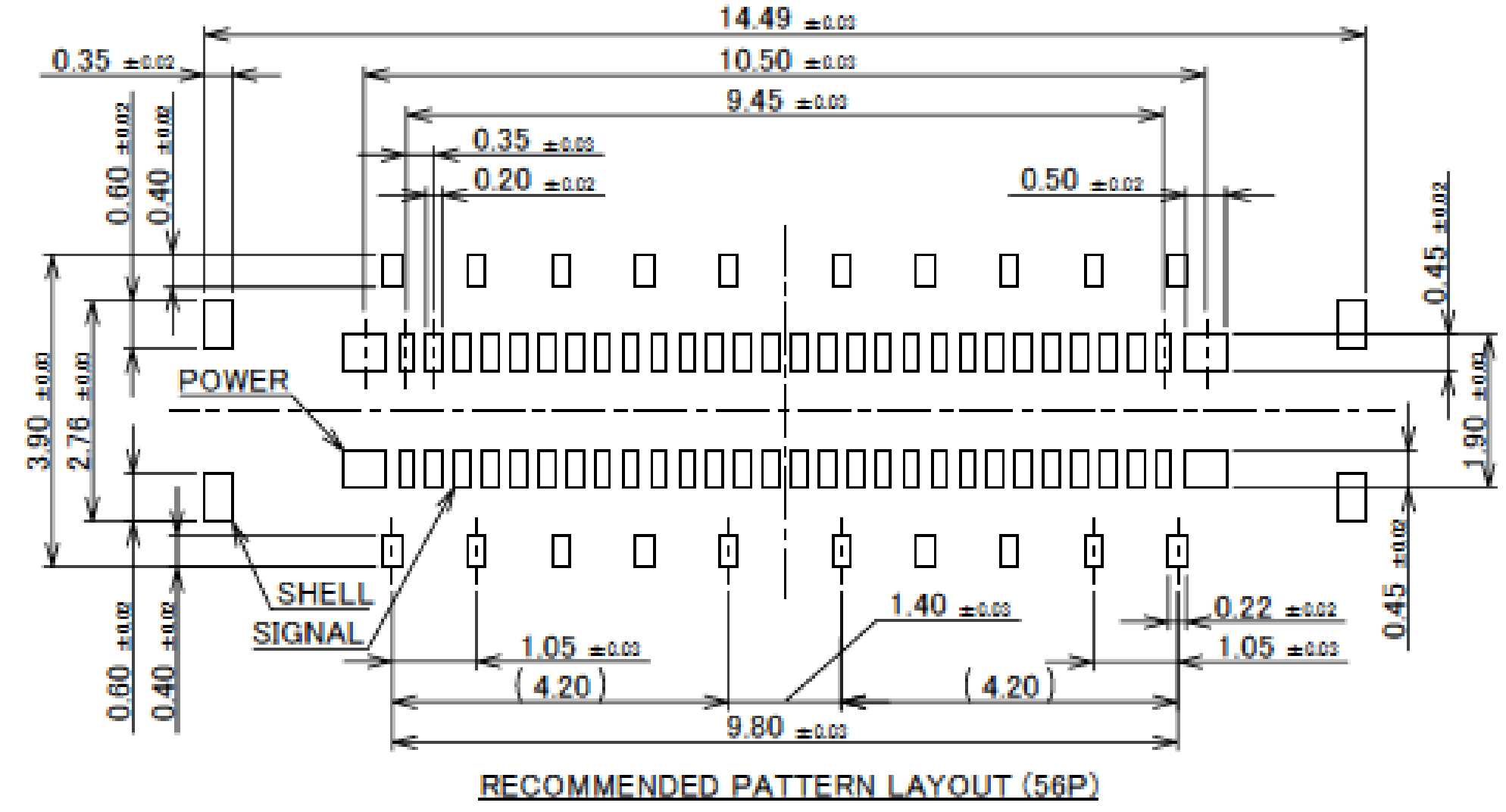
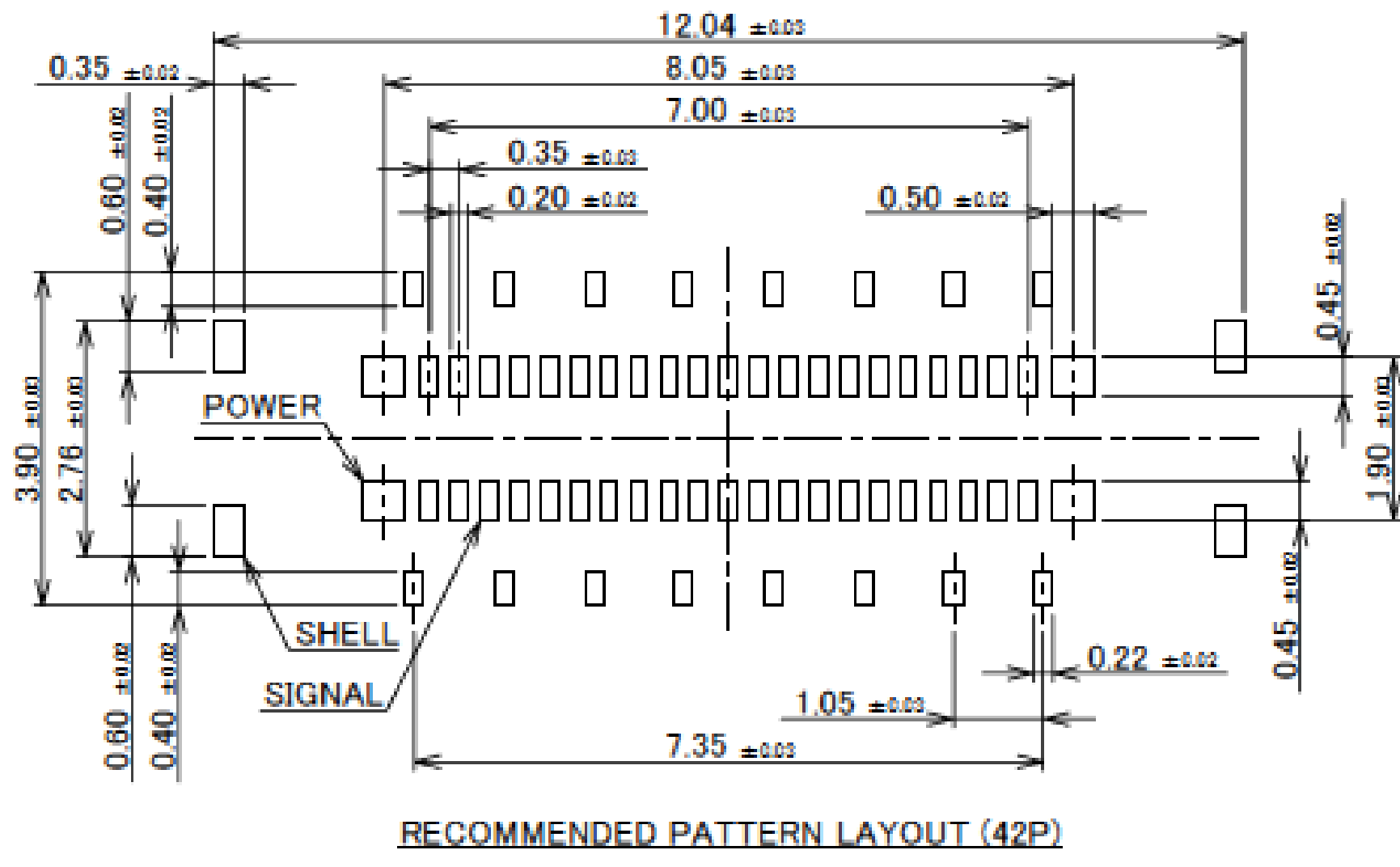

PART No.	SIGNAL POS.	POWER POS.	A
20697-028E-01	28P	4P	9.79
20697-034E-01	34P	4P	10.84
20697-042E-01#	42P	4P	12.24
20697-056E-01#	56P	4P	14.69
20697-062E-01#	62P	4P	15.74

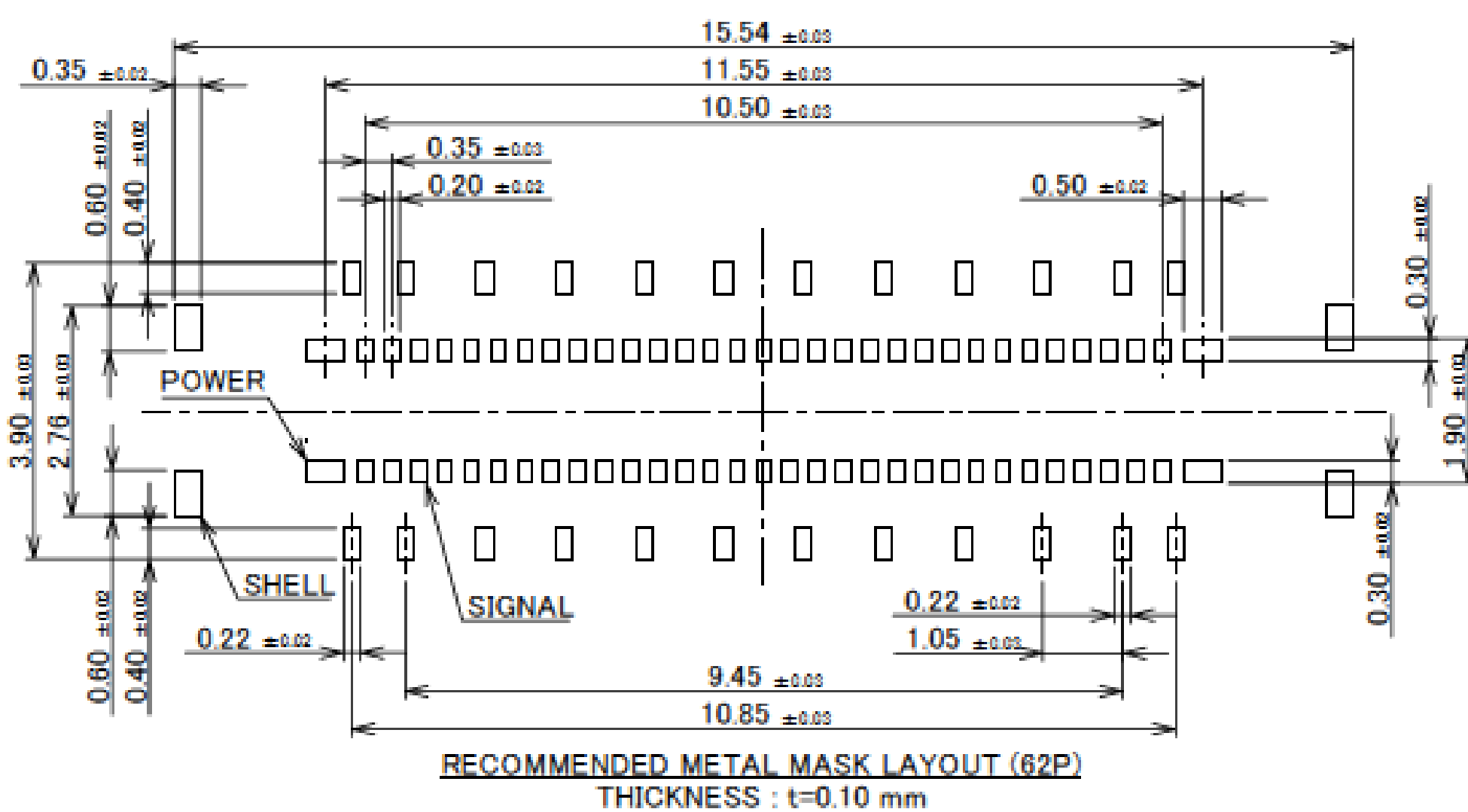
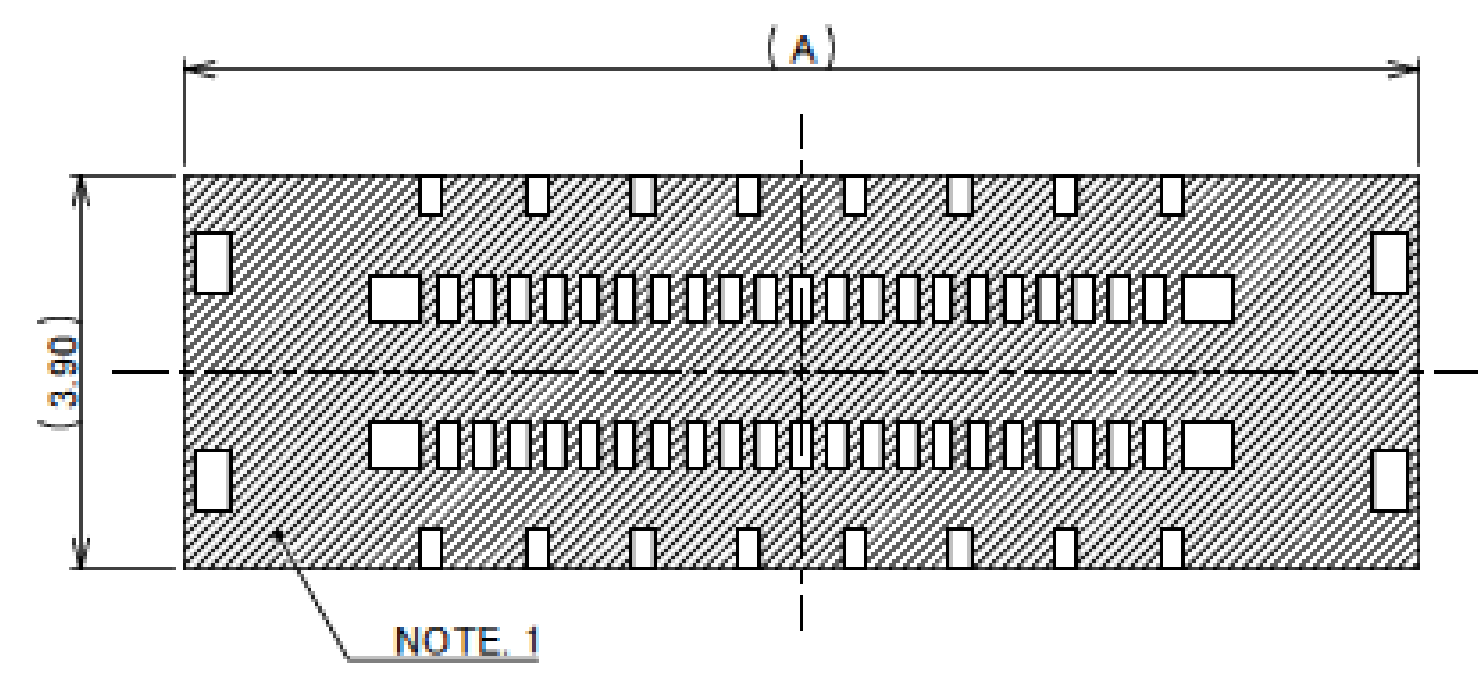
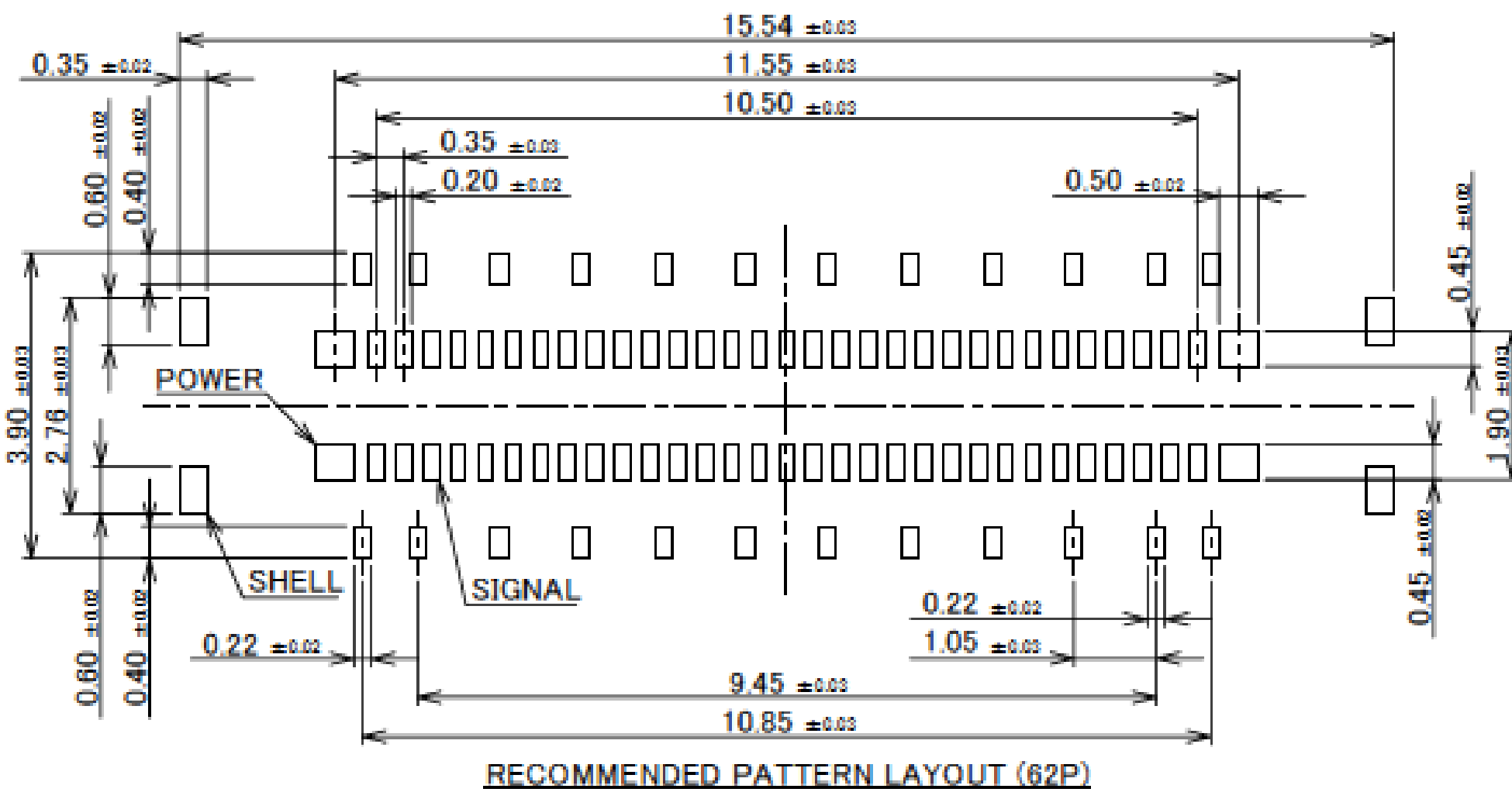

NOTES.
1. THIS AREA CANNOT MOUNT ANOTHER COMPONENTS.

Rev.7

Rev.7

Plug Assembly

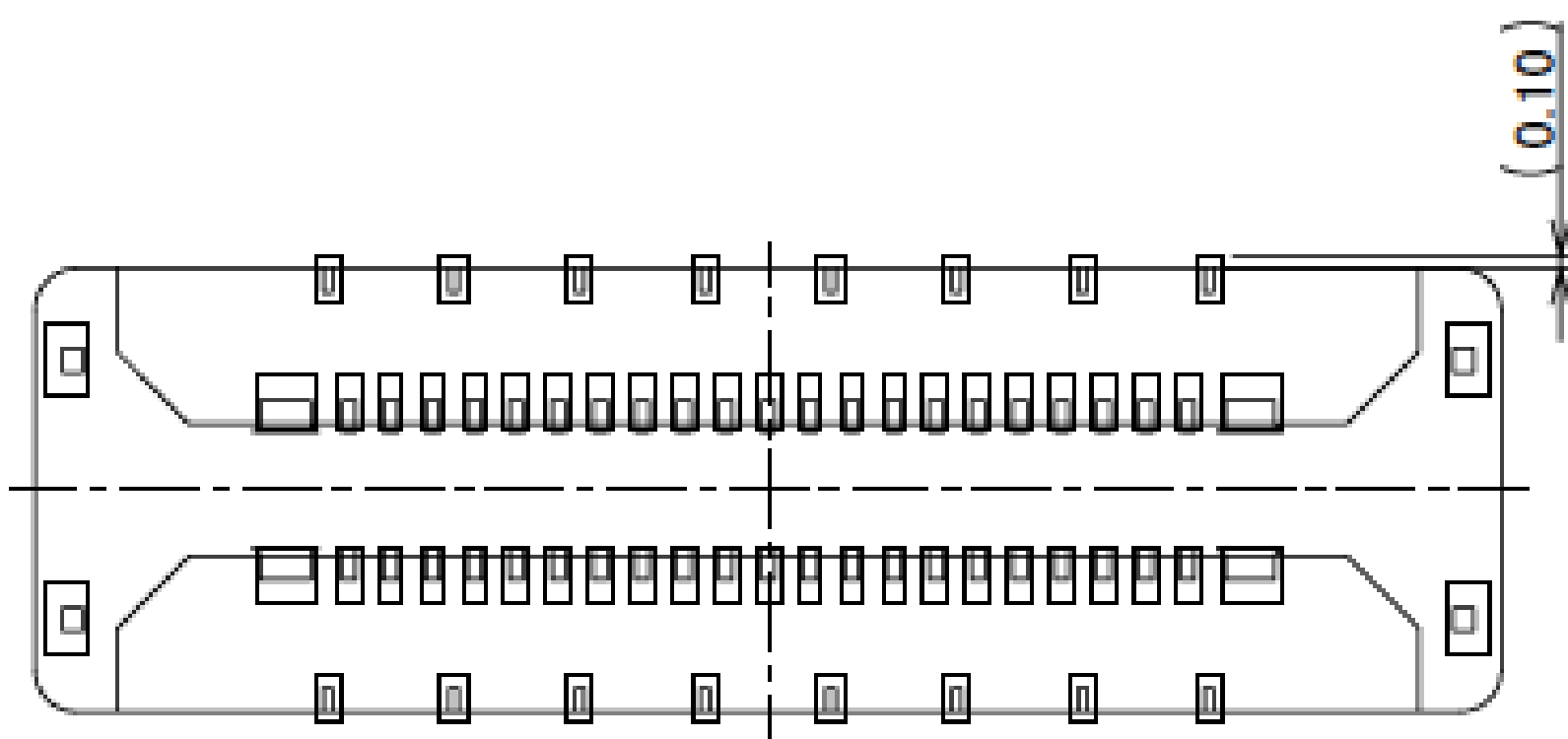

CONNECTOR ON RECOMMENDED FOOTPRINT PATTERN

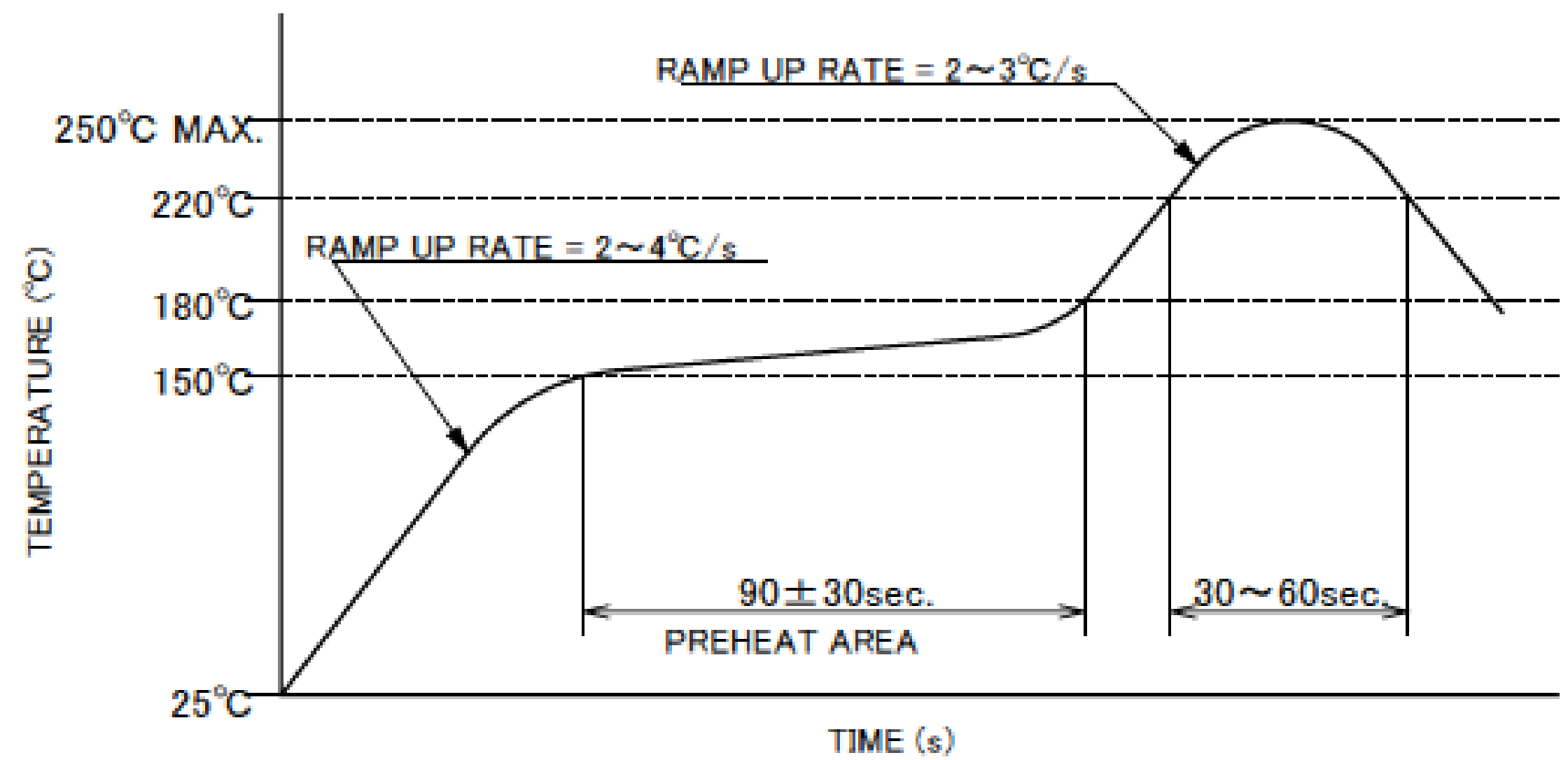

REFLOW TEMPERATURE PROFILE
SENJU METAL INDUSTRY CO., LTD. : M705-SHF(Sn96.5 Ag3.0 Cu0.5)

Rev.7

ITEMS	SPECIFICATION
APPLICABLE CONNECTOR PART No.	20698-0**E-01*
RATING VOLTAGE	60V AC (PER CONTACT PIN)
RATING AMPERAGE (FOR SIGNAL CONTACT)	0.3A AC/DC (PER CONTACT PIN)/ 12.0A AC/DC(TOTAL)
RATING AMPERAGE (FOR POWER CONTACT)	2.2A AC/DC (PER CONTACT PIN)/ 8.8A AC/DC(TOTAL)
OPERATING TEMPERATURE	233~358K(-40°C~+85°C)
OPERATING HUMIDITY	85% MAX.(NON-CONDENSING)
CONTACT RESISTANCE (FOR SIGNAL CONTACT)	INITIAL : 40mohm MAX. / AFTER TEST : Δ 40mohm MAX.
CONTACT RESISTANCE (FOR POWER CONTACT)	INITIAL : 20mohm MAX. / AFTER TEST : Δ 20mohm MAX.
CONTACT RESISTANCE (FOR GROUND)	INITIAL : 20mohm MAX. / AFTER TEST : Δ 20mohm MAX.
INSULATION RESISTANCE	INITIAL : 1,000Mohm MIN. / AFTER TEST : 500Mohm MIN.
DIELECTRIC WITHSTANDING VOLTAGE	AC250V 1min
DURABILITY	30 CYCLES
MATING FORCE (INITIAL)	$1.0N \times n + 4.0N$ MAX.
UNMATING FORCE (AFTER TEST)	$0.1N \times n + 0.4N$ MIN.
COPLANARITY	CONTACT AND POWER CONTACT: 0.08 MAX. SHELL: 0.105 MAX.
PRODUCT SPECIFICATION	PRS-2187
TEST REPORT	TR-16014
PACKING STANDARD	PST-15083 (10K/REEL) PST-16125 (5K/REEL)
INSTRUCTION MANUAL	HIM-15020
APPEARANCE CRITERIA No.	QLS-A***

Rev.7

Receptacle Assembly

Recommended P/N		20698-0**E-01#				
PART No.	SIGNAL POS.	POWER POS.	A	B	C	D
20698-028E-01	28P	4P	8.95	6.54	5.60	4.55
20698-034E-01	34P	4P	10.00	7.59	6.65	5.60
20698-042E-01#	42P	4P	11.40	8.99	8.05	7.00
20698-056E-01#	56P	4P	13.85	11.44	10.50	9.45
20698-062E-01#	62P	4P	14.90	12.49	11.55	10.50

20698-0**E-01M
 WITHOUT : 10,000 pcs/REEL
 WITH : 5,000 pcs/REEL
 Pos.

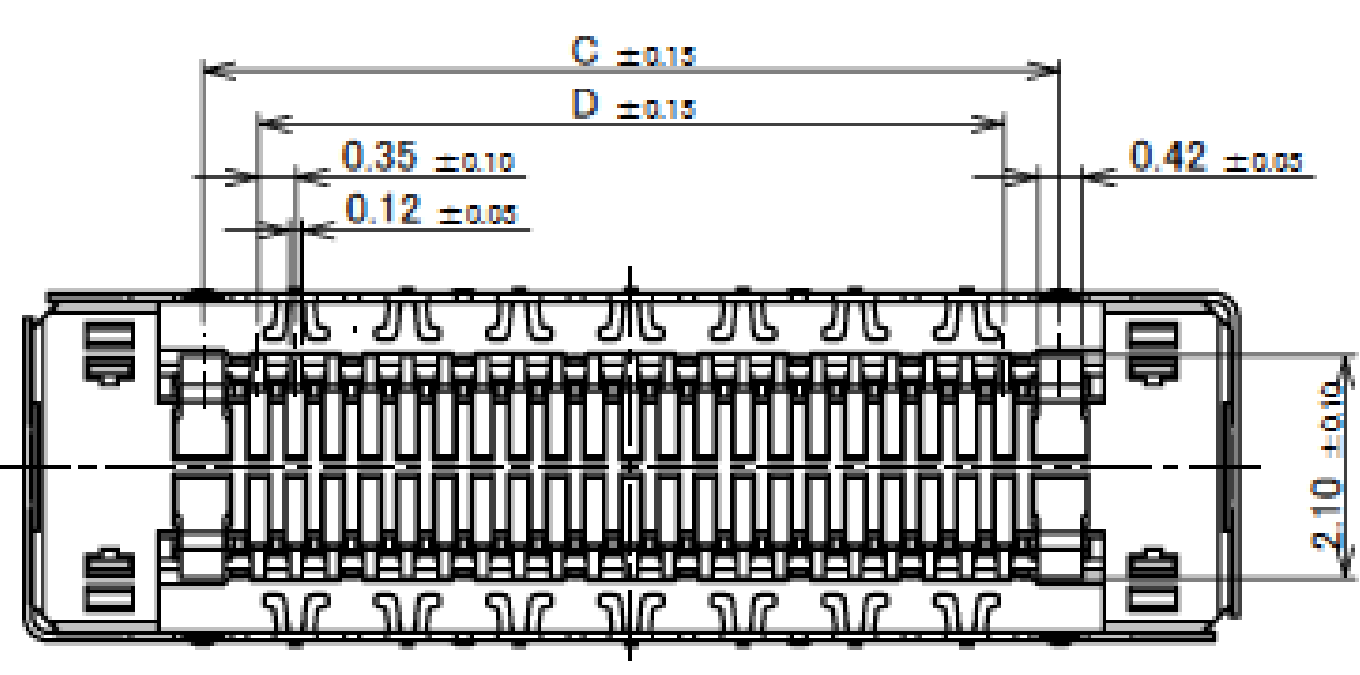
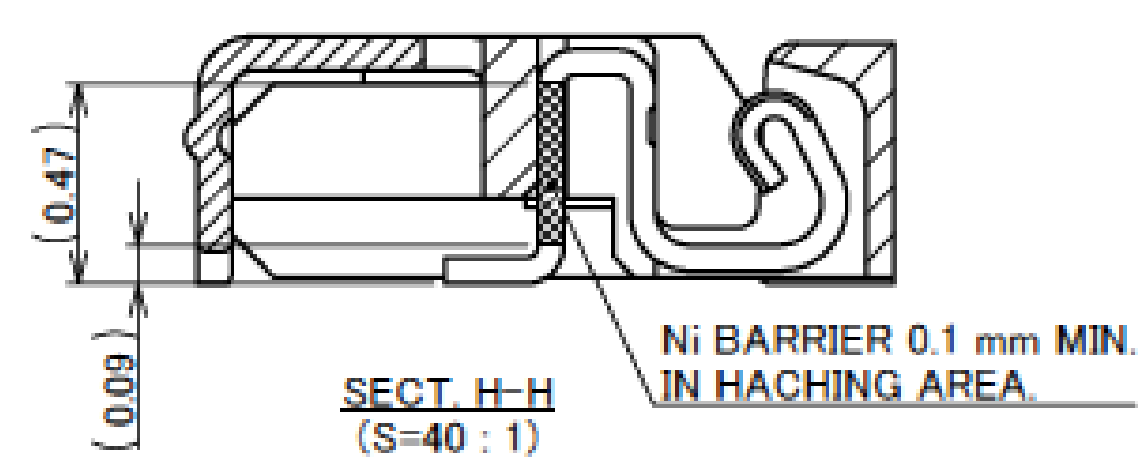
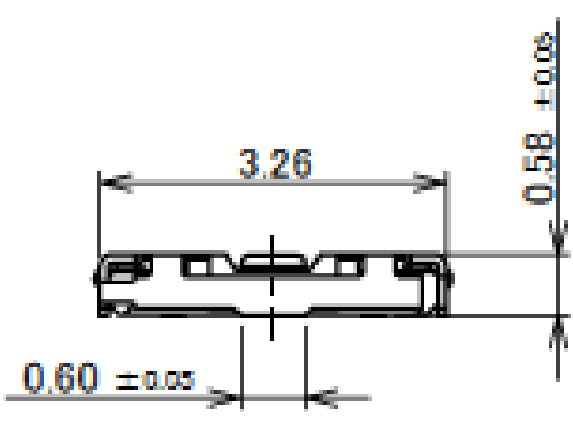
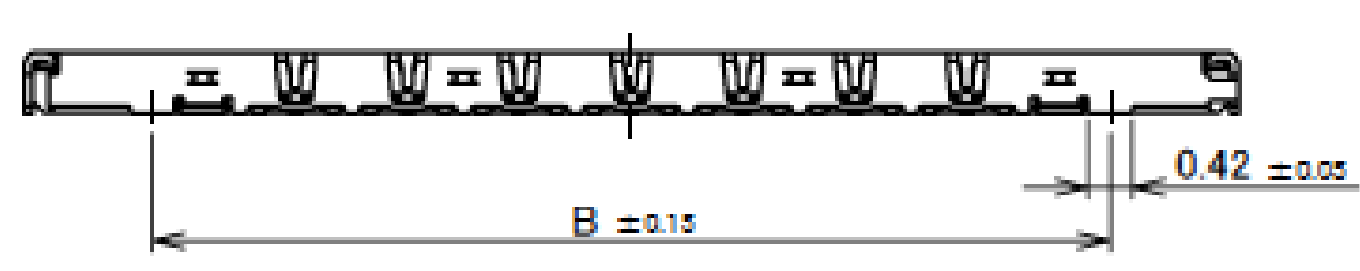
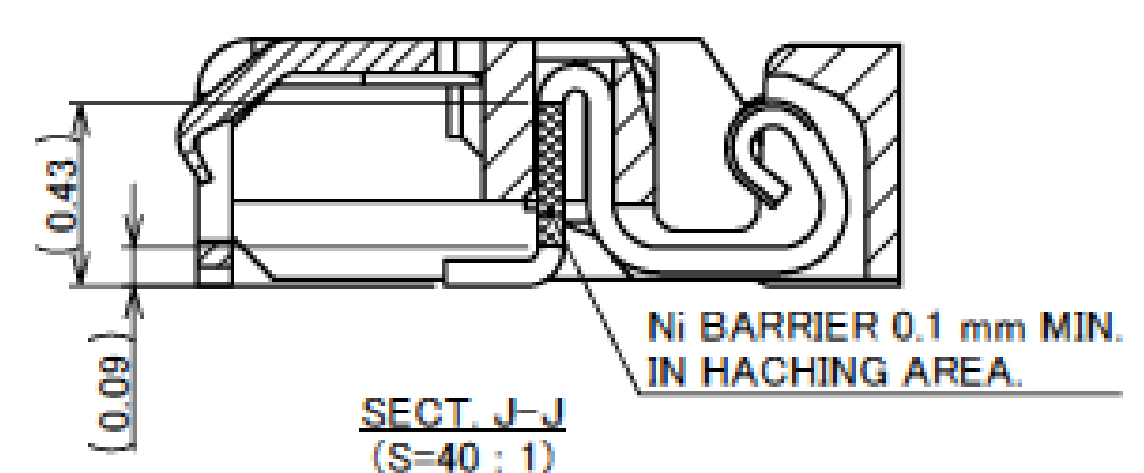
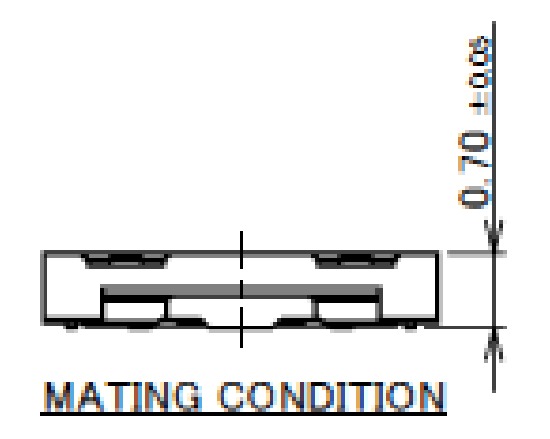
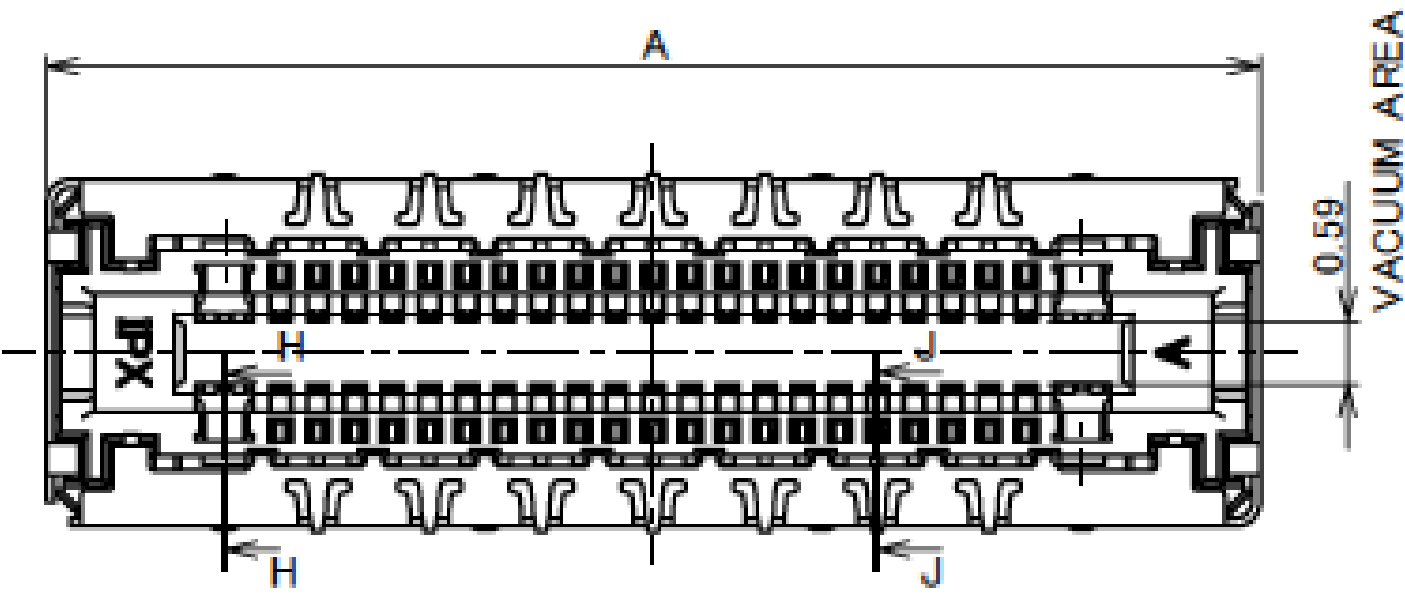
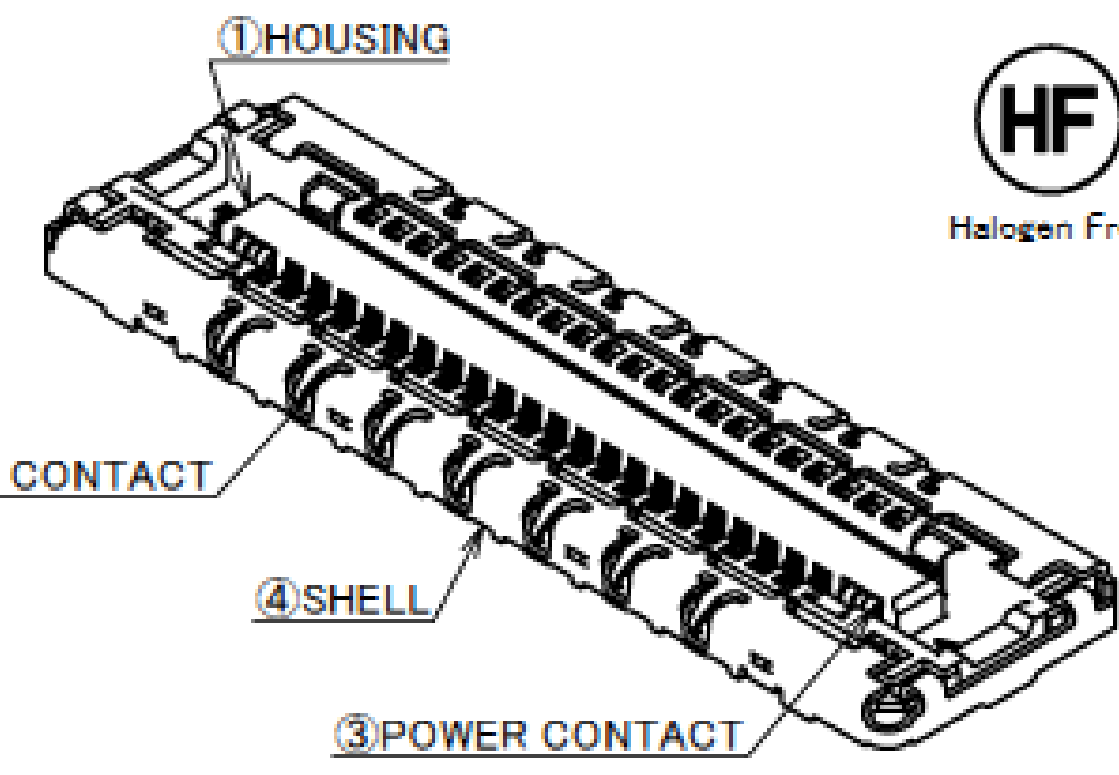

4	SHELL	PHOSPHOR BRONZE	ALL OVER Ni 1.27 μm MIN. Au 0.01 μm MIN.
3	POWER CONTACT	CORSON ALLOY	ALL OVER Ni 1.27 μm MIN. CONTACT PART Au 0.05 μm MIN. SOLDERING PART Au 0.02 μm MIN.
2	SIGNAL CONTACT	CORSON ALLOY	ALL OVER Ni 1.27 μm MIN. CONTACT PART Au 0.10 μm MIN. SOLDERING PART Au 0.02 μm MIN.
1	HOUSING	LCP	UL94V-0, BLACK
NO.	DISCRIPTION	MATERIAL	FINISH, REMARKS

Rev.10

PART No.	SIGNAL POS.	POWER POS.
20698-028E-01	28P	4P
20698-034E-01	34P	4P
20698-042E-01#	42P	4P
20698-056E-01#	56P	4P
20698-062E-01#	62P	4P

20698-0**E-01M
 WITHOUT : 10,000 pcs/REEL
 WITH : 5,000 pcs/REEL
 Pos.

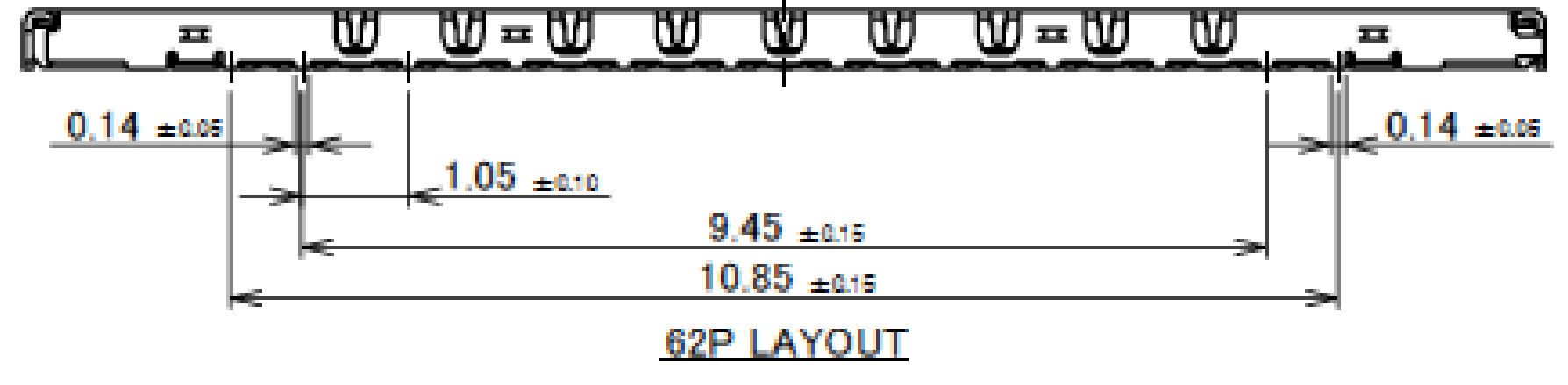
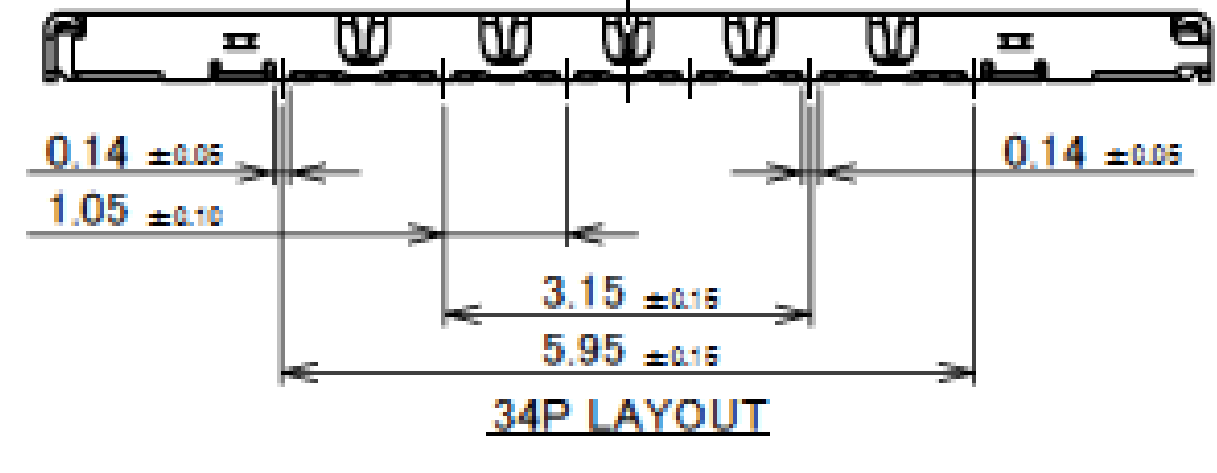
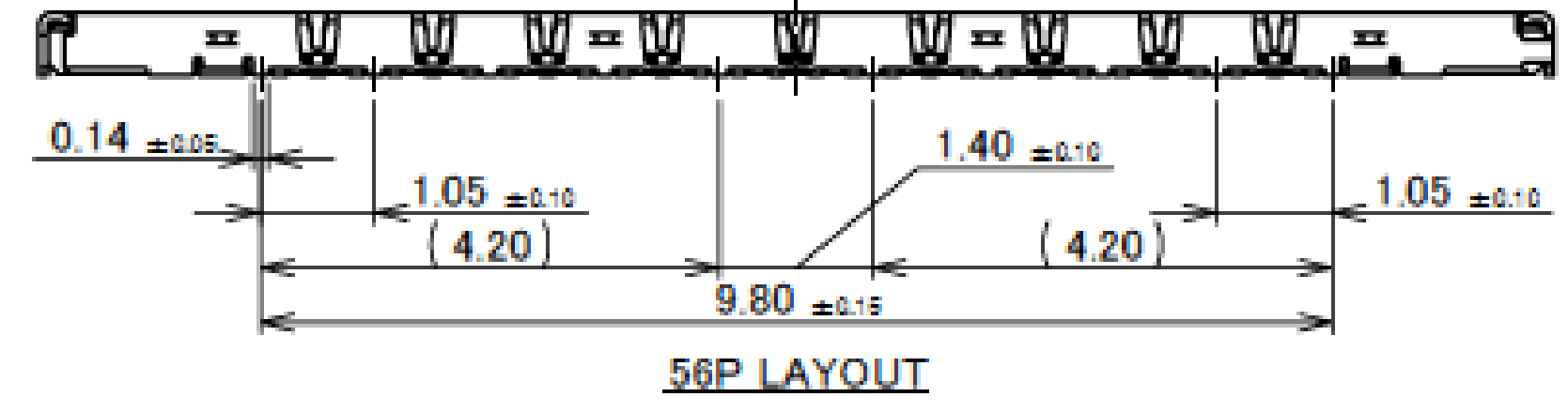
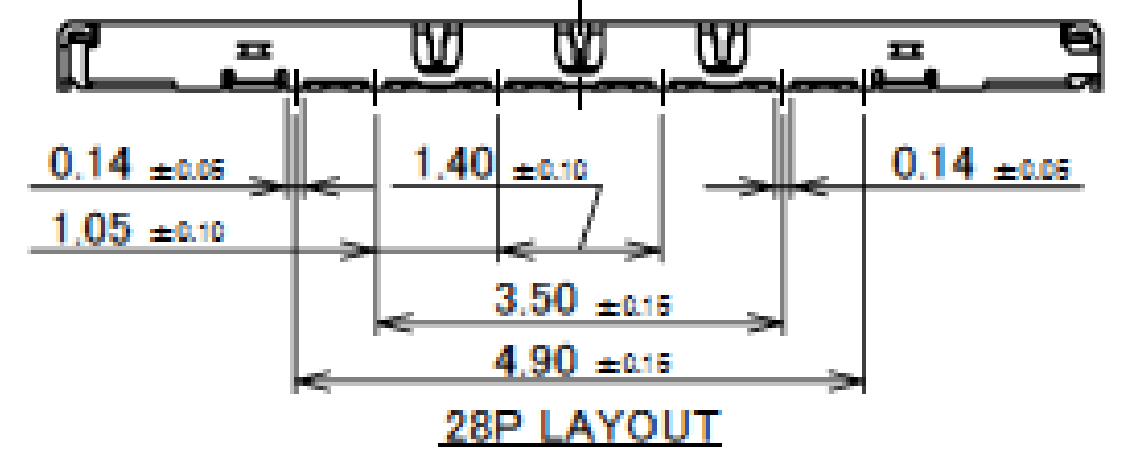
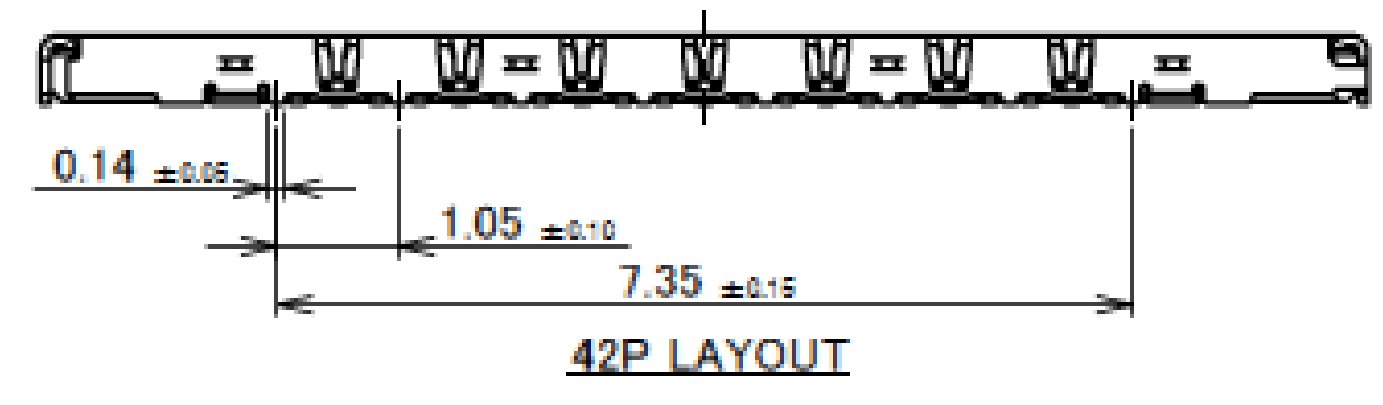

Rev.10

Receptacle Assembly

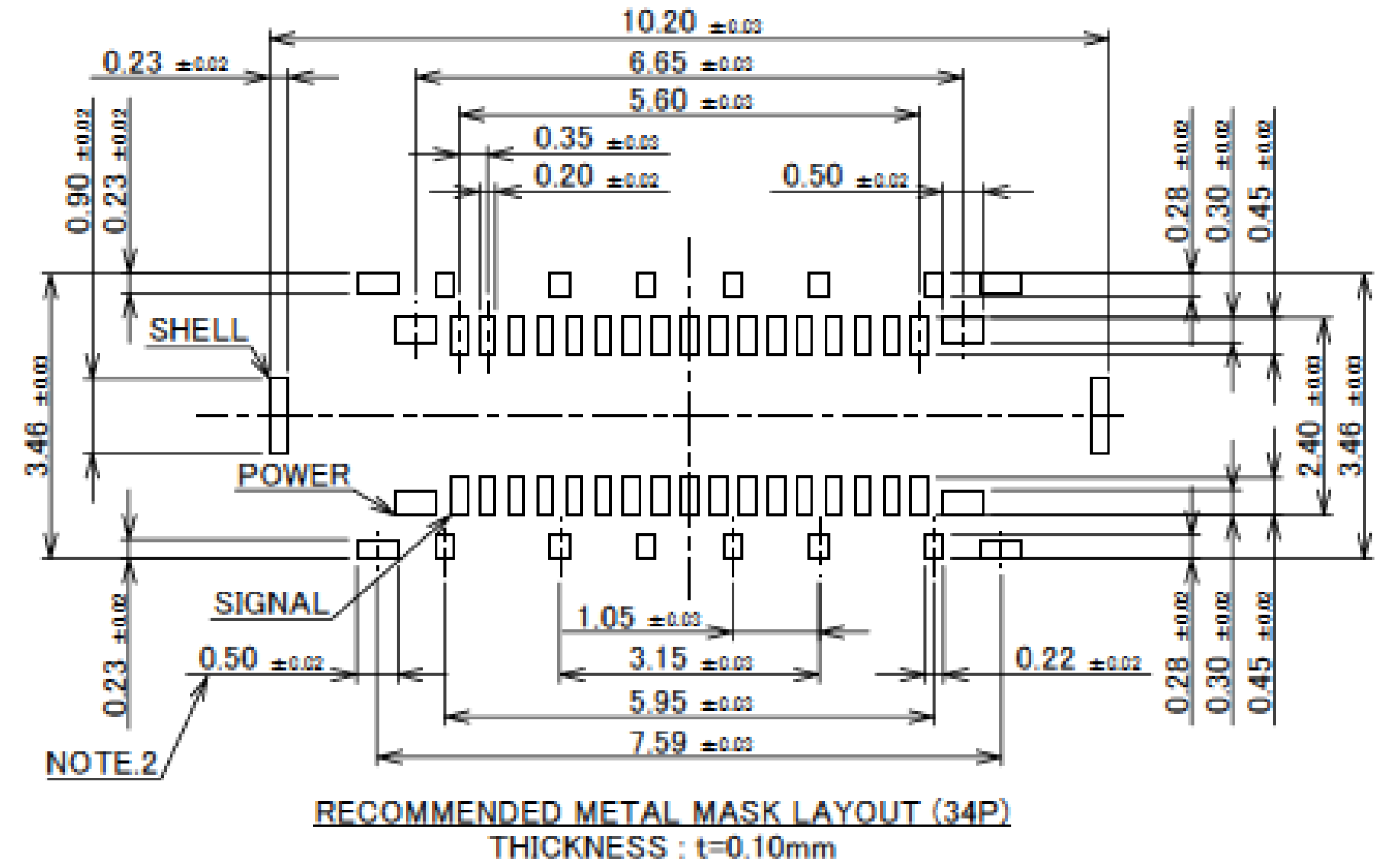
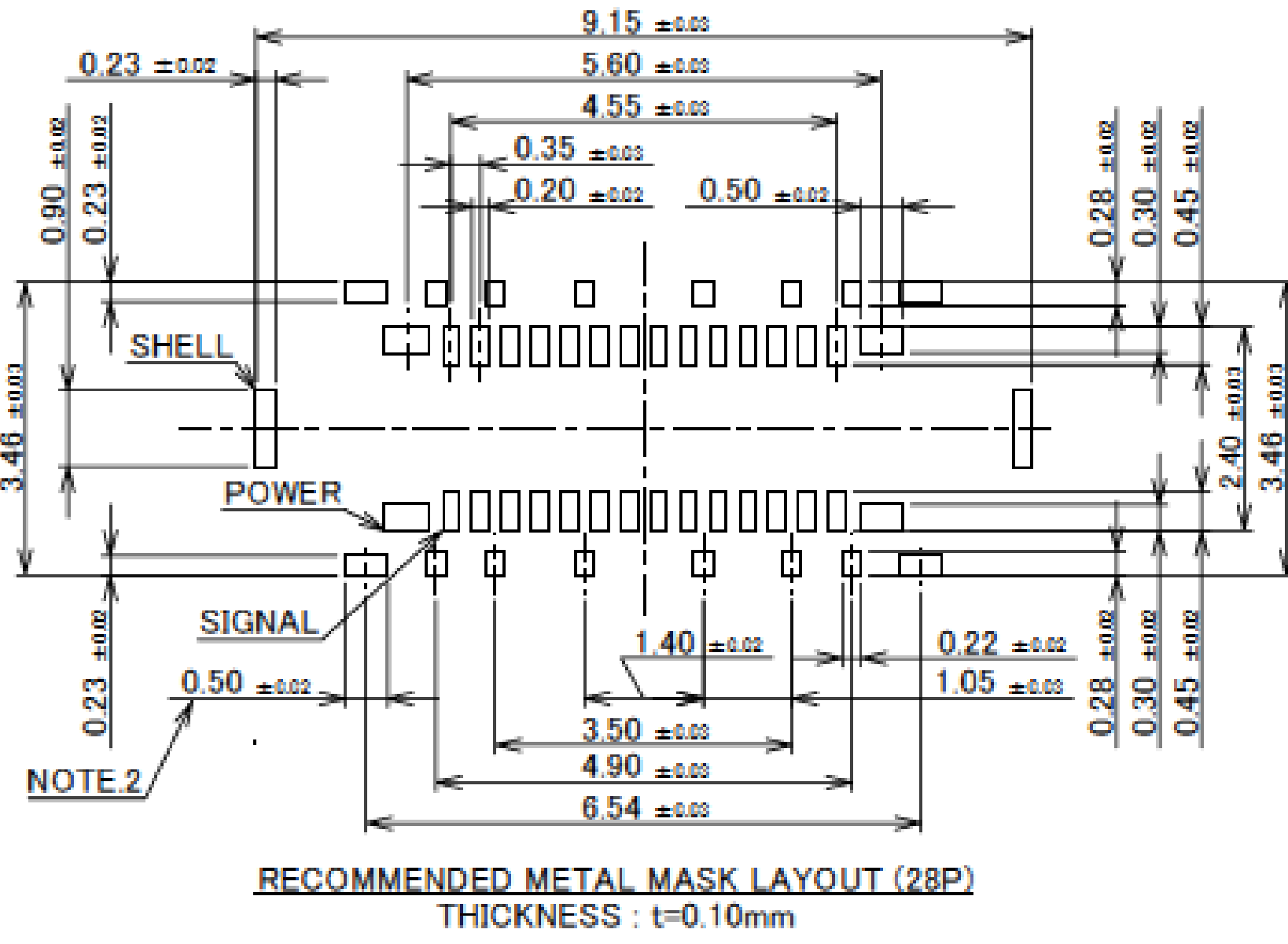
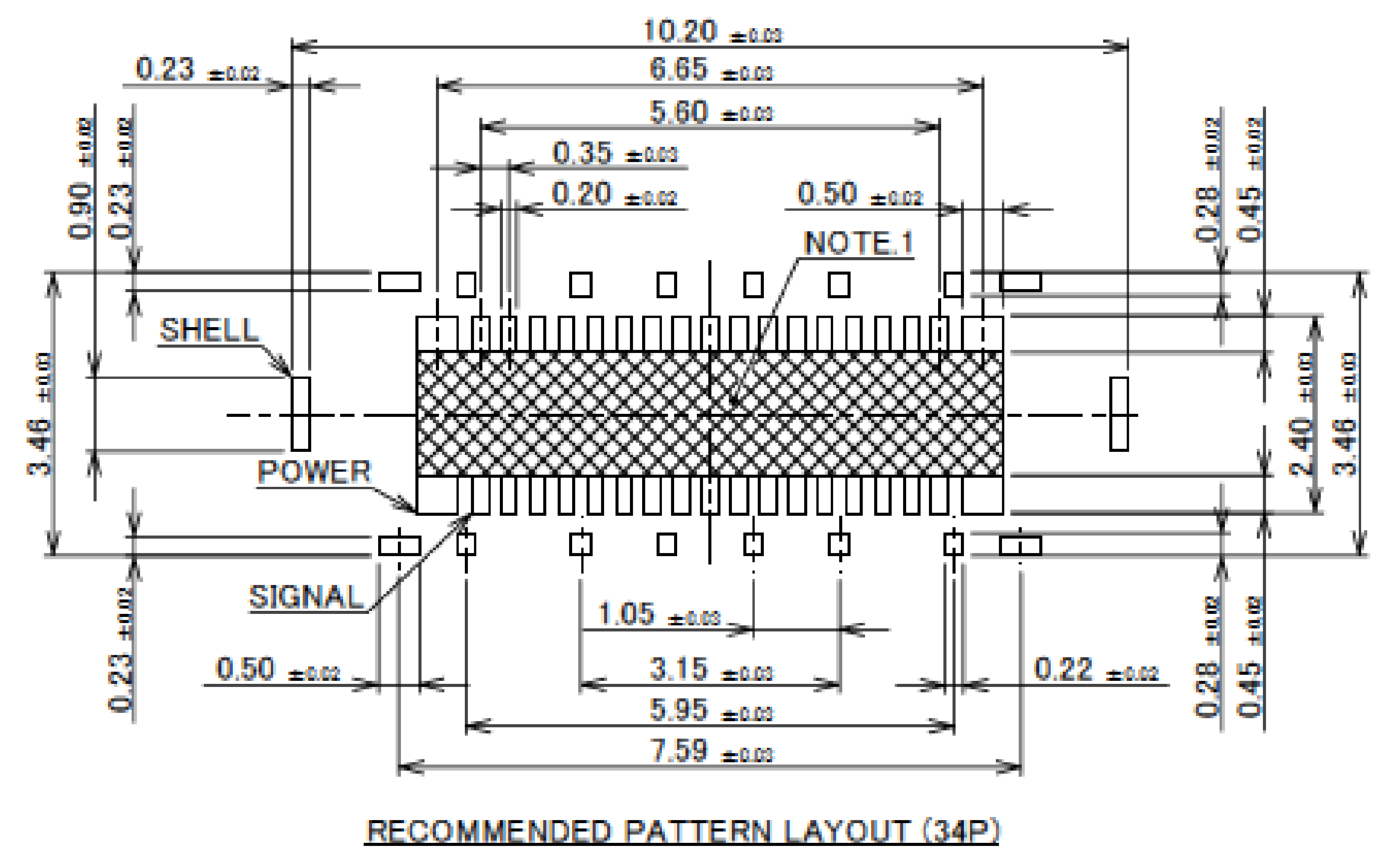
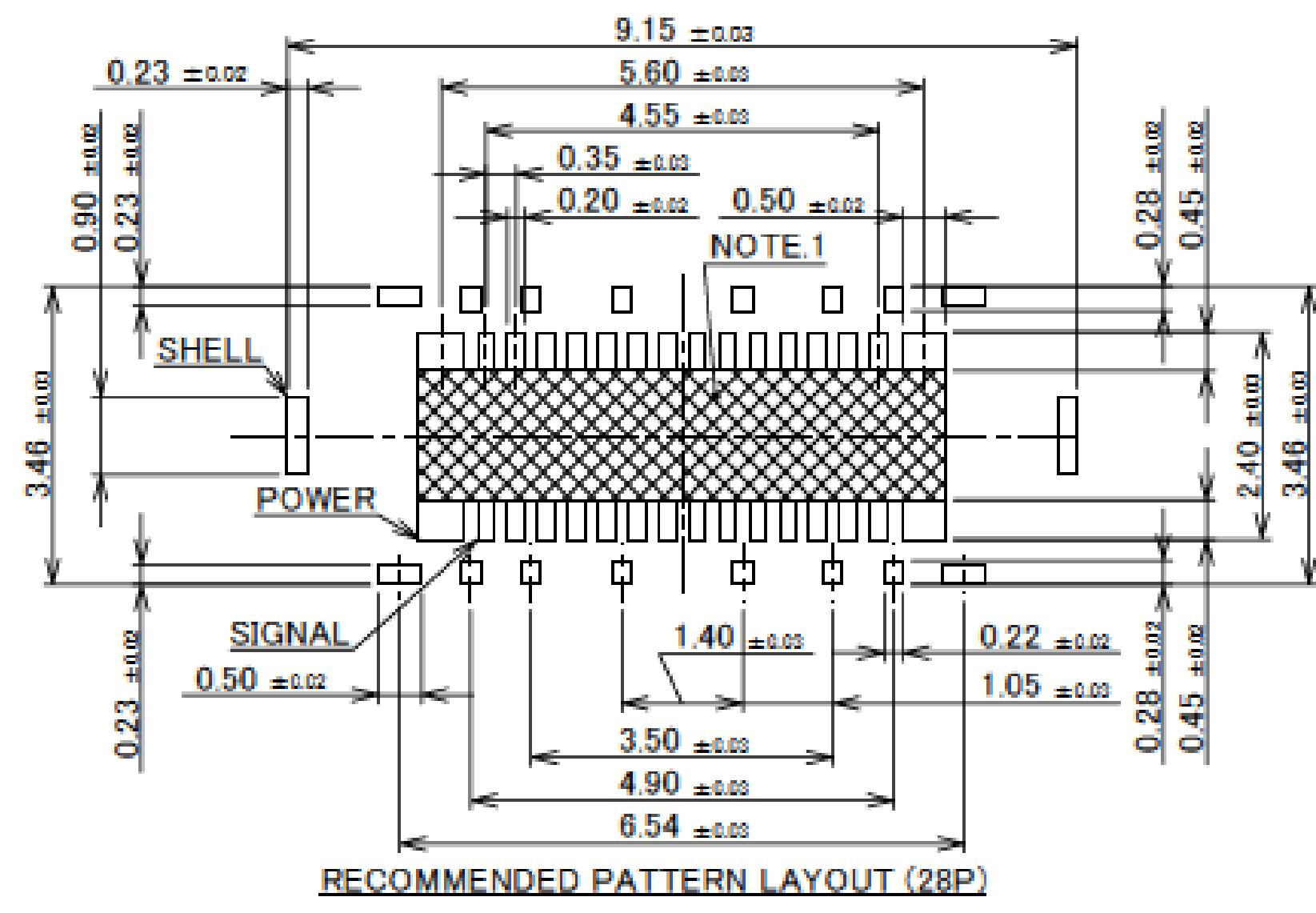

- NOTES**
 1. SOLDER RESIST MUST BE APPLIED TO THIS AREA.
 2. WHEN THE THICKNESS OF THE METAL MASK IS 0.12 mm, PLEASE SET IT TO 0.41 mm.

Rev.10

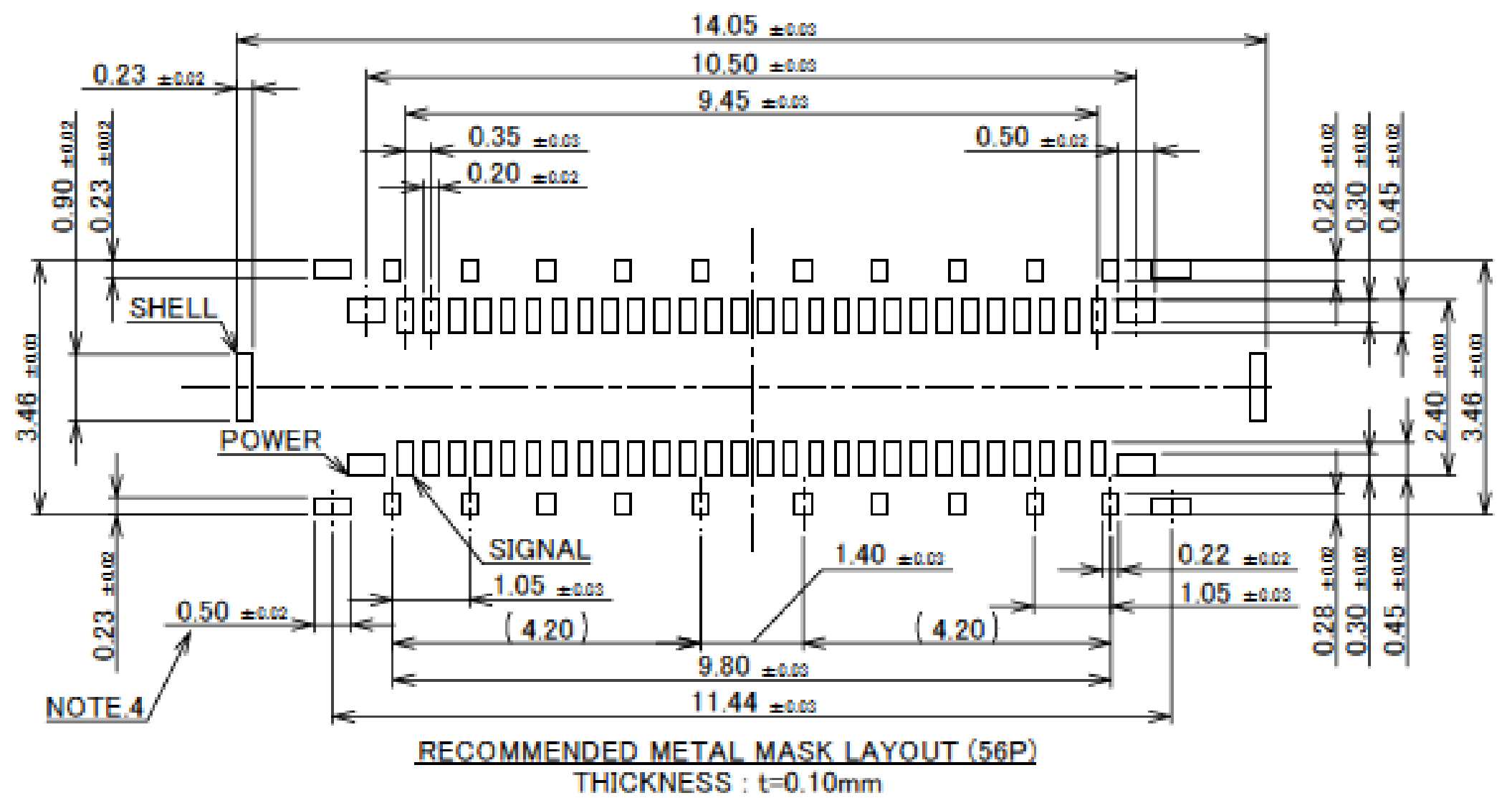
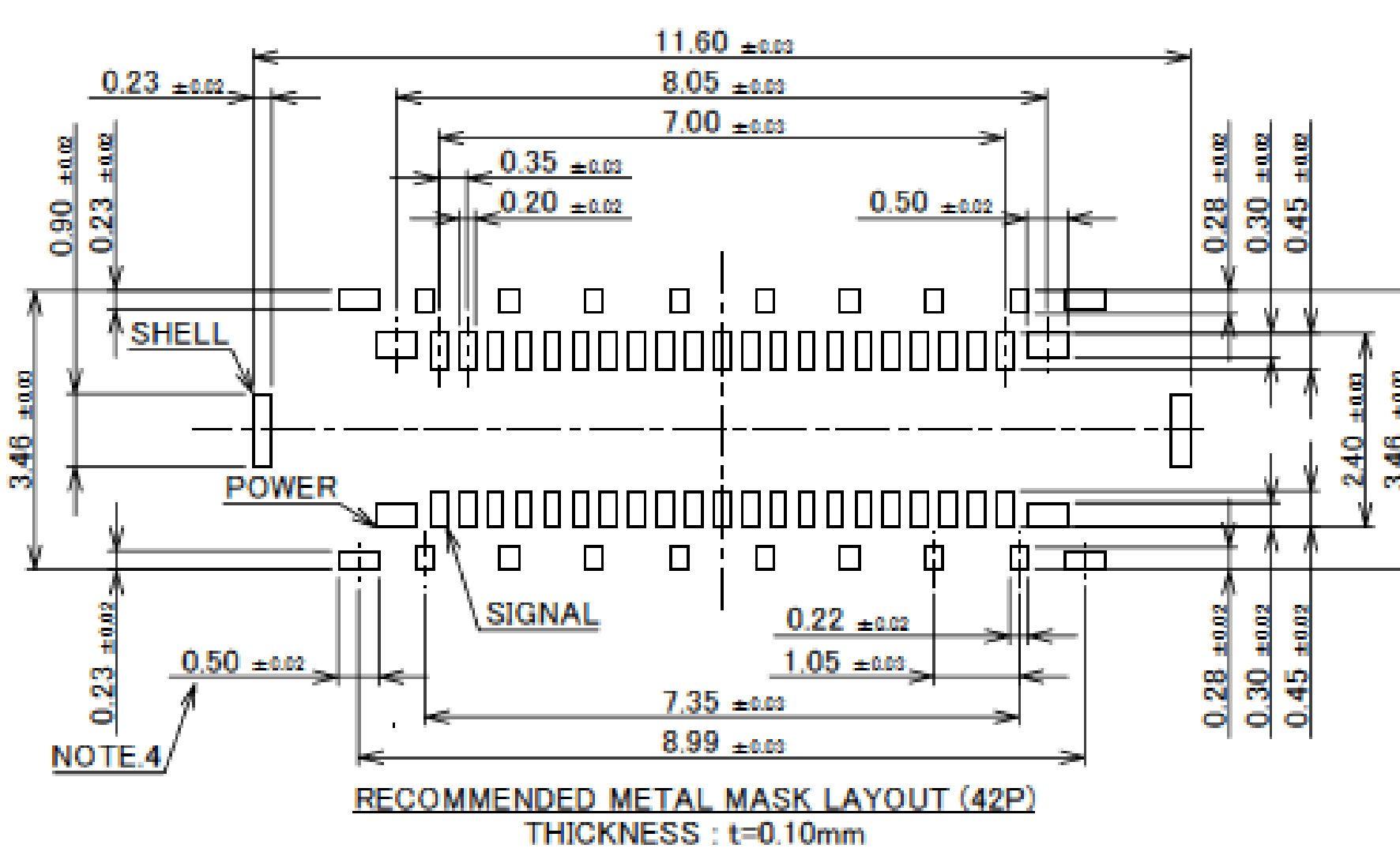
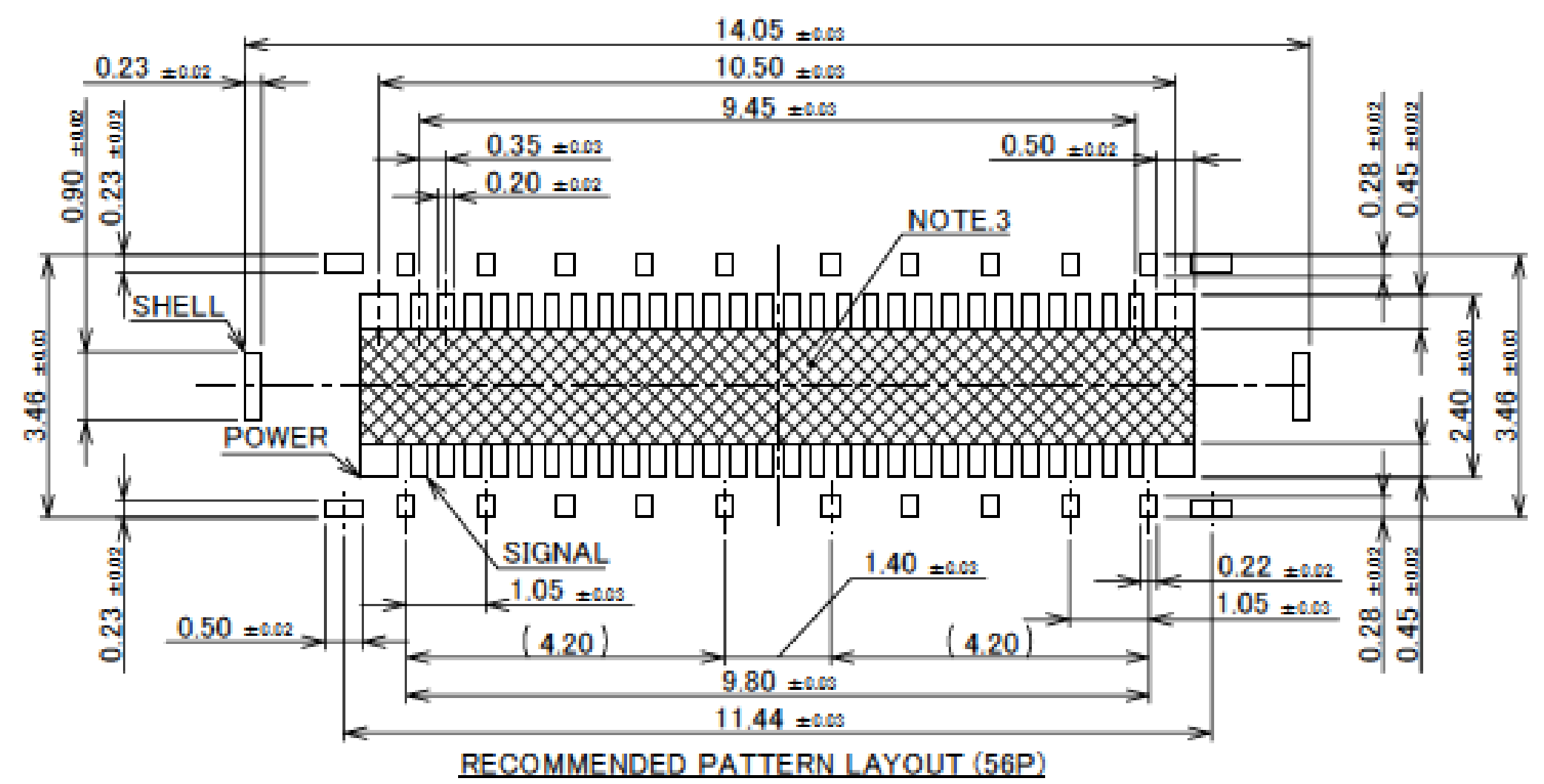
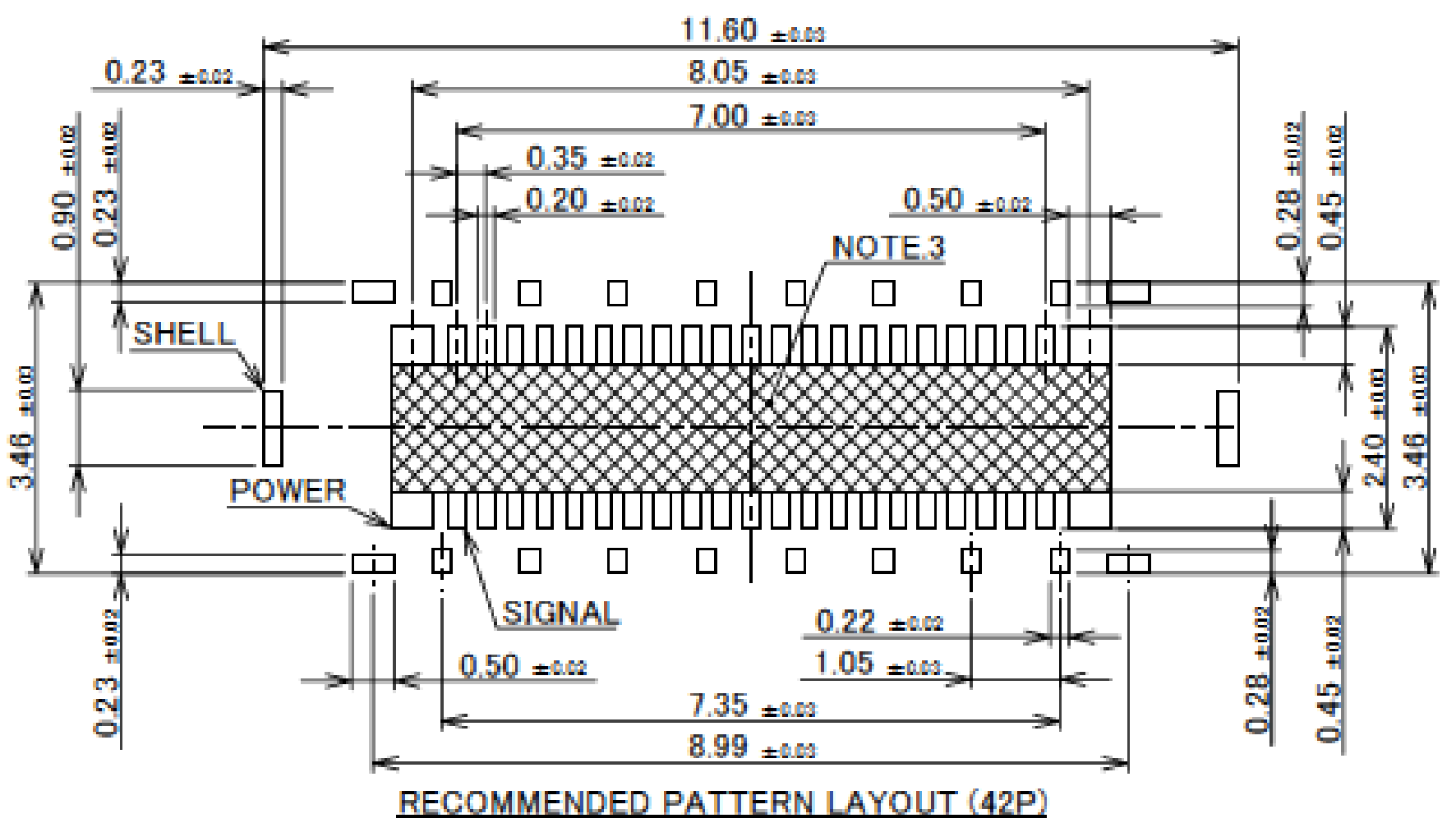

- NOTES**
 3. SOLDER RESIST MUST BE APPLIED TO THIS AREA.
 4. WHEN THE THICKNESS OF THE METAL MASK IS 0.12 mm, PLEASE SET IT TO 0.41 mm.

Rev.10

Receptacle Assembly

PART No.	SIGNAL POS.	POWER POS.	E
20698-028E-01	28P	4P	9.15
20698-034E-01	34P	4P	10.20
20698-042E-01#	42P	4P	11.60
20698-056E-01#	56P	4P	14.05
20698-062E-01#	62P	4P	15.10

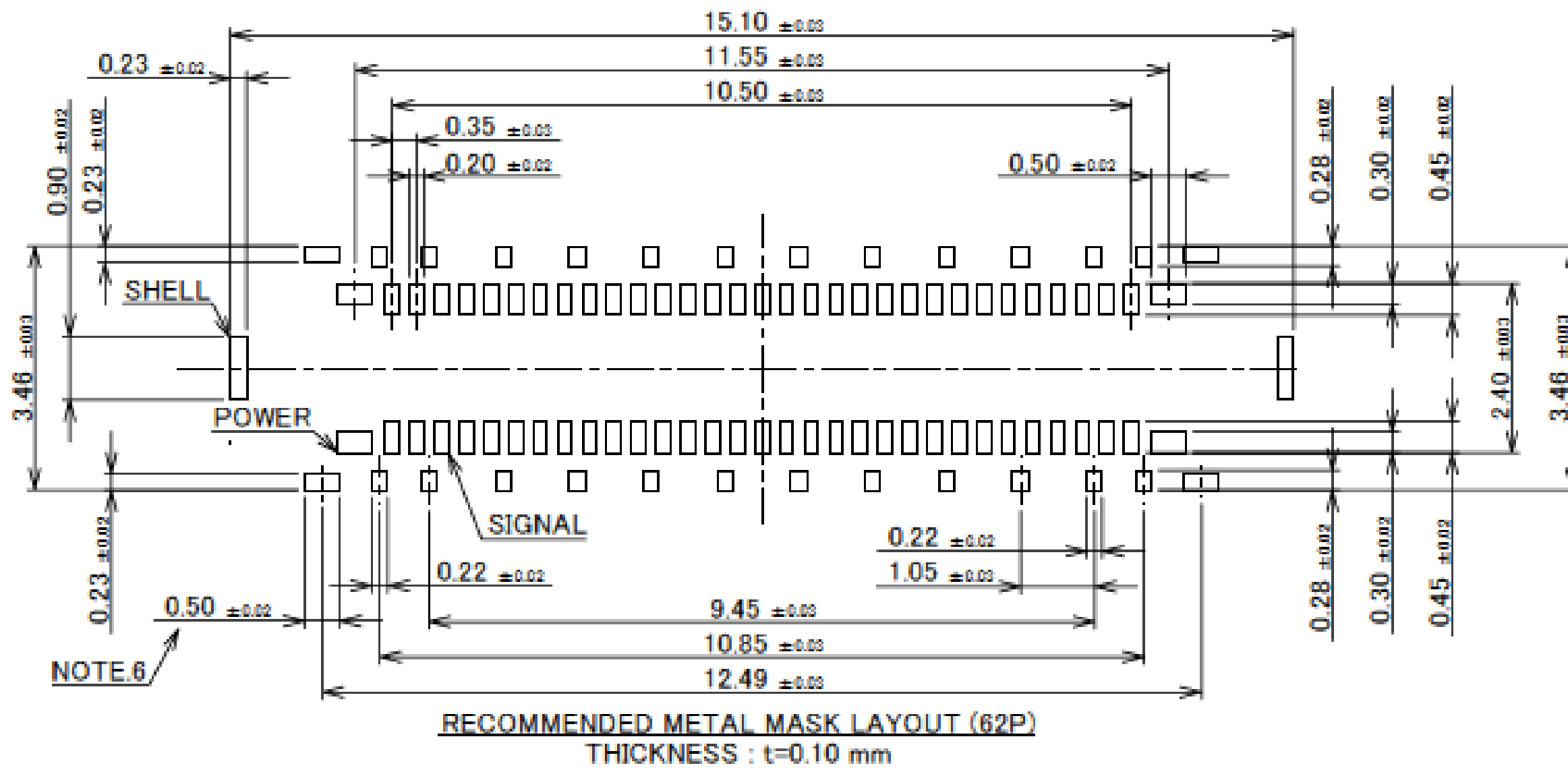
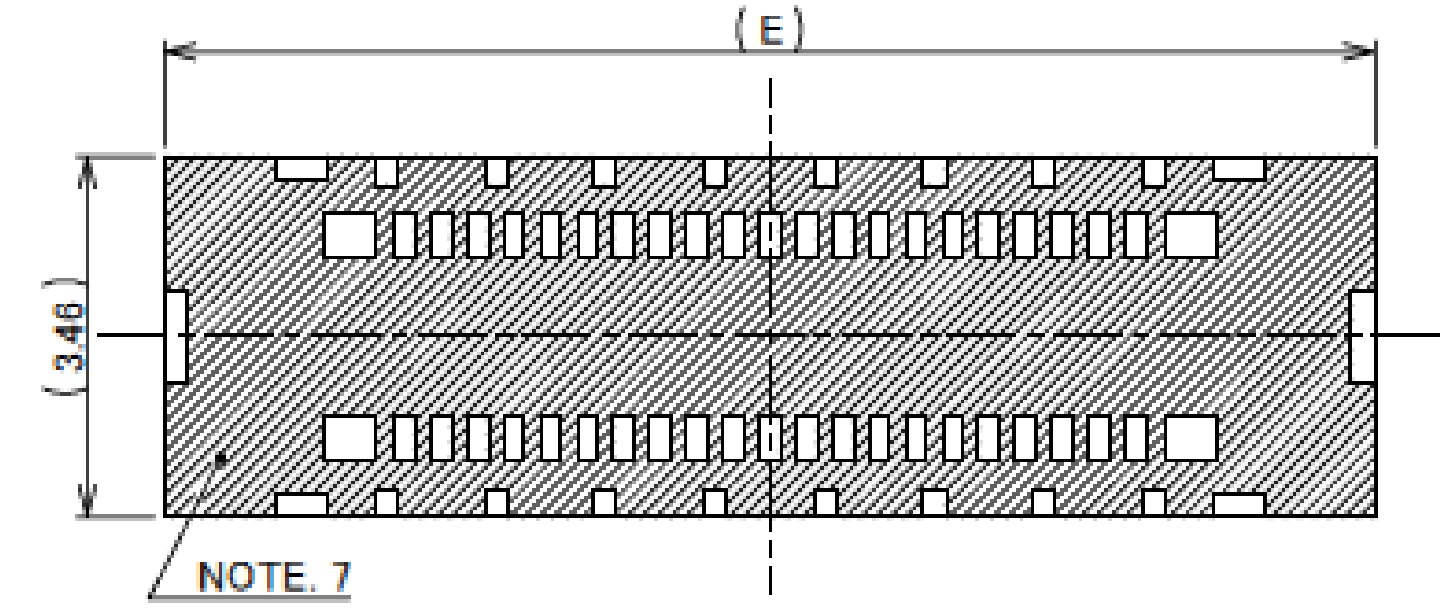
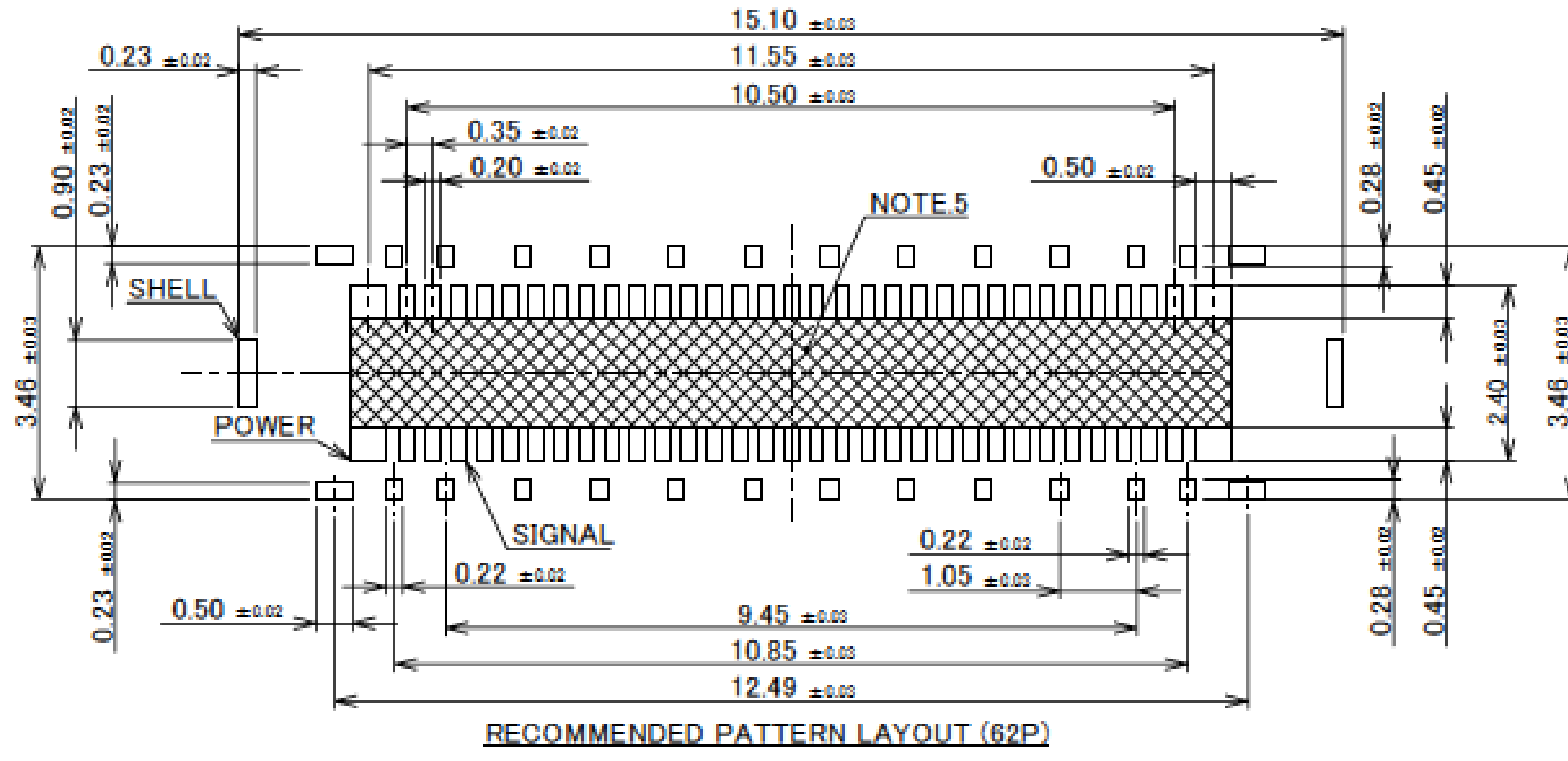

- NOTES
- SOLDER RESIST MUST BE APPLIED TO THIS AREA.
 - WHEN THE THICKNESS OF THE METAL MASK IS 0.12 mm, PLEASE SET IT TO 0.41 mm.
 - DO NOT MOUNT ANOTHER COMPONENT IN THIS AREA.

Rev.10

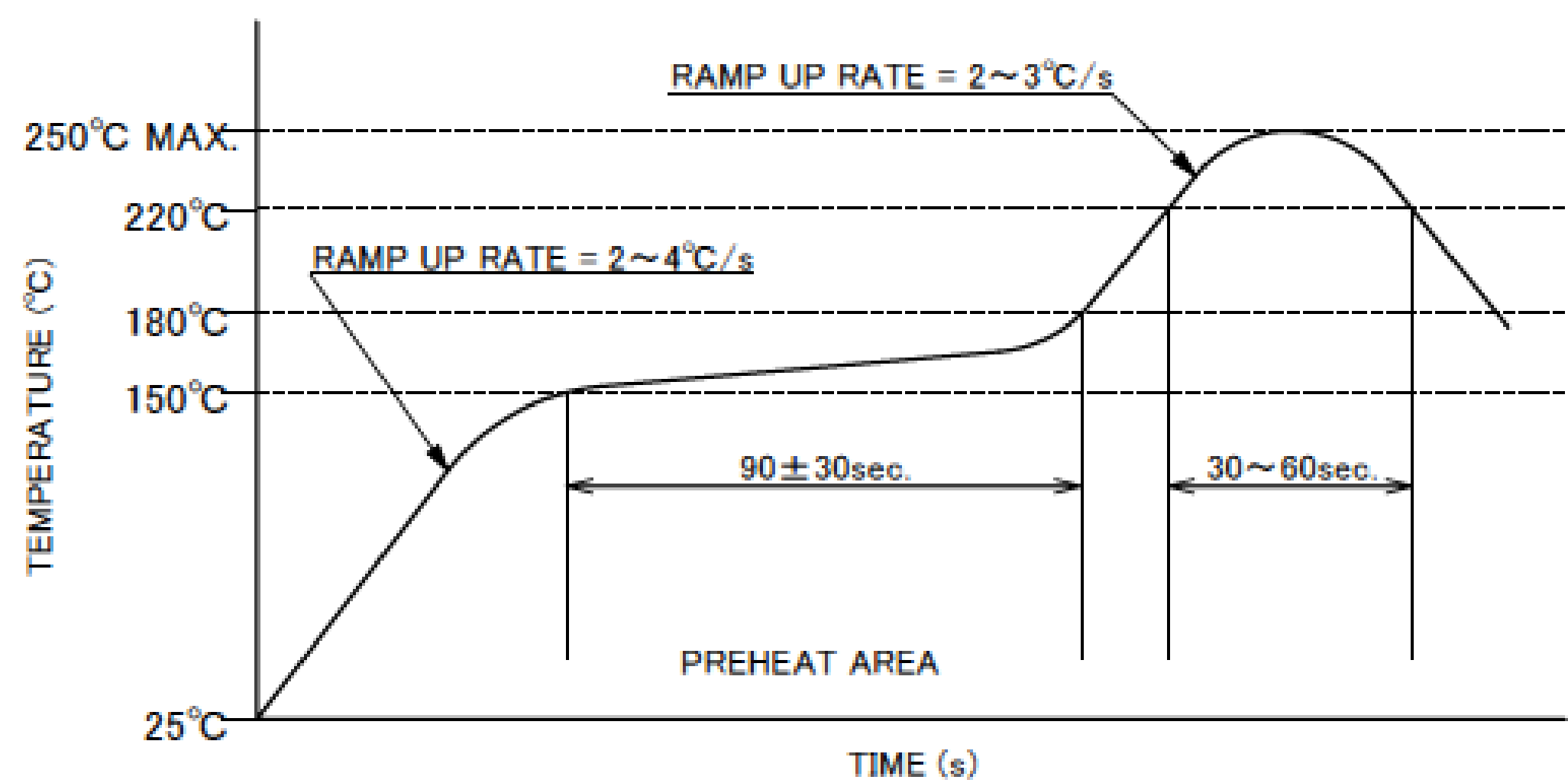

REFLOW TEMPERATURE PROFILE
SENJU METAL INDUSTRY CO., LTD. : M705-SHF(Sn96.5 Ag3.0 Cu0.5)

Receptacle Assembly

ITEMS	SPECIFICATION
APPLICABLE CONNECTOR PART No.	20697-0**E-01*
RATING VOLTAGE	60V AC (PER CONTACT PIN)
RATING AMPERAGE (FOR SIGNAL CONTACT)	0.3A AC/DC (PER CONTACT PIN)/ 12.0A AC/DC(TOTAL)
RATING AMPERAGE (FOR POWER CONTACT)	2.2A AC/DC (PER CONTACT PIN)/ 8.8A AC/DC(TOTAL)
OPERATING TEMPERATURE	233~358K(-40°C~+85°C)
OPERATING HUMIDITY	85% MAX.(NON-CONDENSING)
CONTACT RESISTANCE (FOR SIGNAL CONTACT)	INITIAL : 40mohm MAX. / AFTER TEST : \triangle 40mohm MAX.
CONTACT RESISTANCE (FOR POWER CONTACT)	INITIAL : 20mohm MAX. / AFTER TEST : \triangle 20mohm MAX.
CONTACT RESISTANCE (FOR GROUND)	INITIAL : 20mohm MAX. / AFTER TEST : \triangle 20mohm MAX.
INSULATION RESISTANCE	INITIAL : 1,000Mohm MIN. / AFTER TEST : 500Mohm MIN.
DIELECTRIC WITHSTANDING VOLTAGE	AC250V 1min
DURABILITY	30 CYCLES
MATING FORCE (INITIAL)	$1.0N \times n + 4.0N$ MAX.
UNMATING FORCE (AFTER TEST)	$0.1N \times n + 0.4N$ MIN.
COPLANARITY	0.08 MAX.
PRODUCT SPECIFICATION	PRS-2187
TEST REPORT	TR-16014
PACKING STANDARD	PST-15084 (10K/REEL) PST-16126 (5K/REEL)
INSTRUCTION MANUAL	HIM-15020
APPEARANCE CRITERIA No.	QLS-A***

Rev.10

Custom Connectors Available

 RF Connector

MHF® series



 CABLINE® series
Micro-coaxial/Twinax/
Discrete Wire Connector

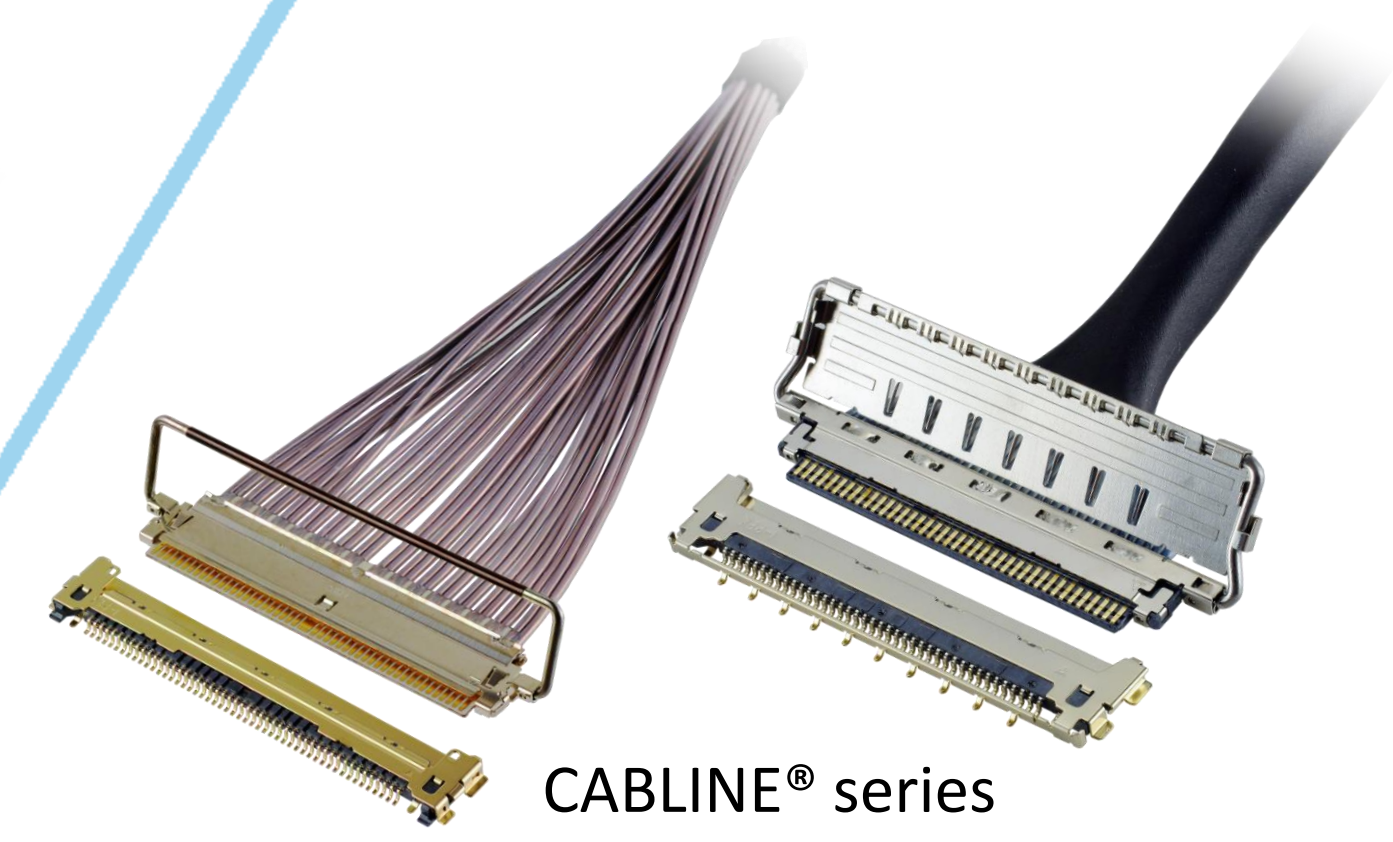

 Optical Module

LIGHTPASS® series



NOVASTACK® series

 Board-to-Board Connector

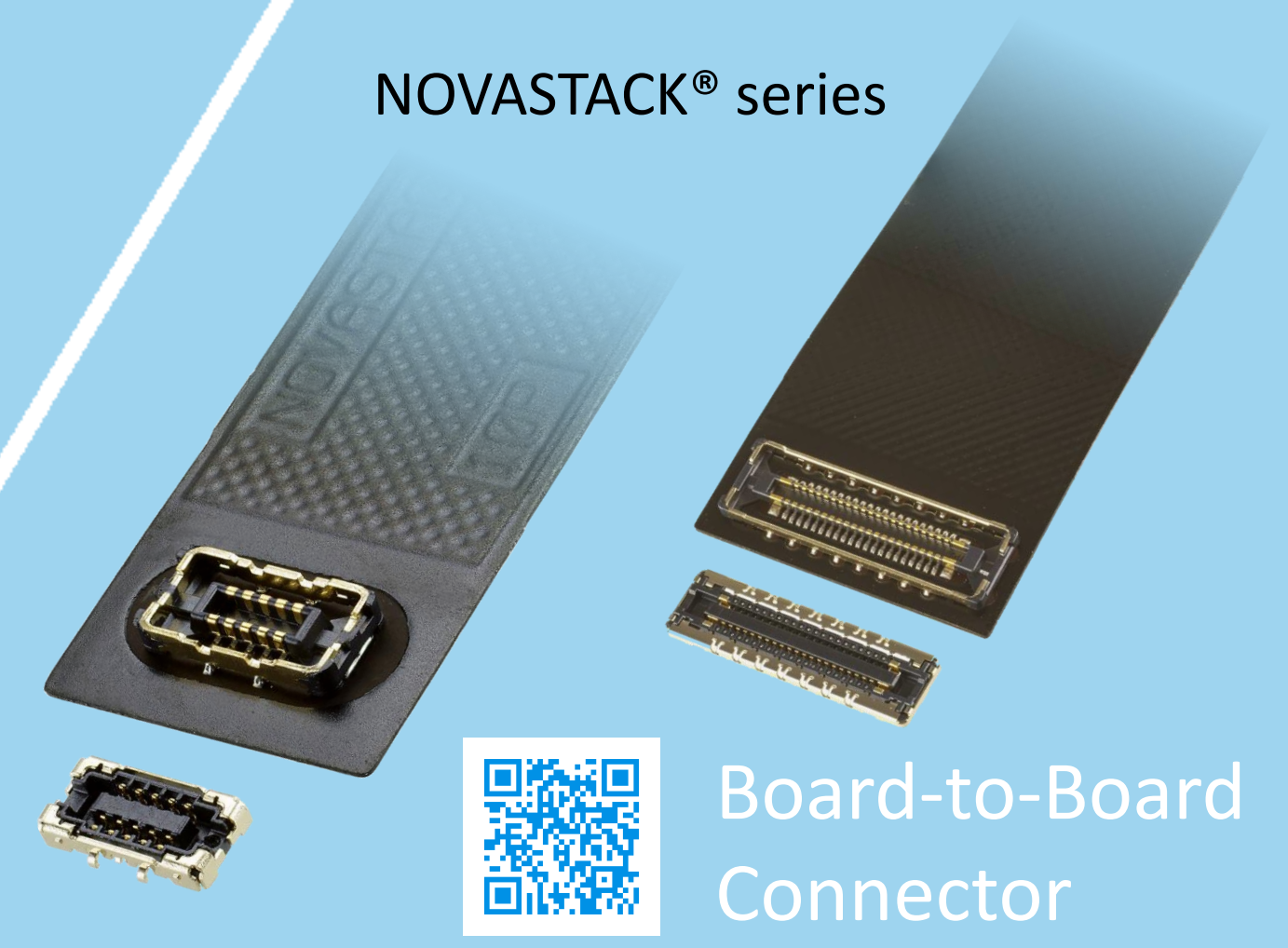

 Power Connector/
Terminal

AP series

ISH® series



MINIFLEX® series

EVAFLEX® series

 FPC FFC Connector



Inquiry



MINIDOCK® series

 I/O Connector

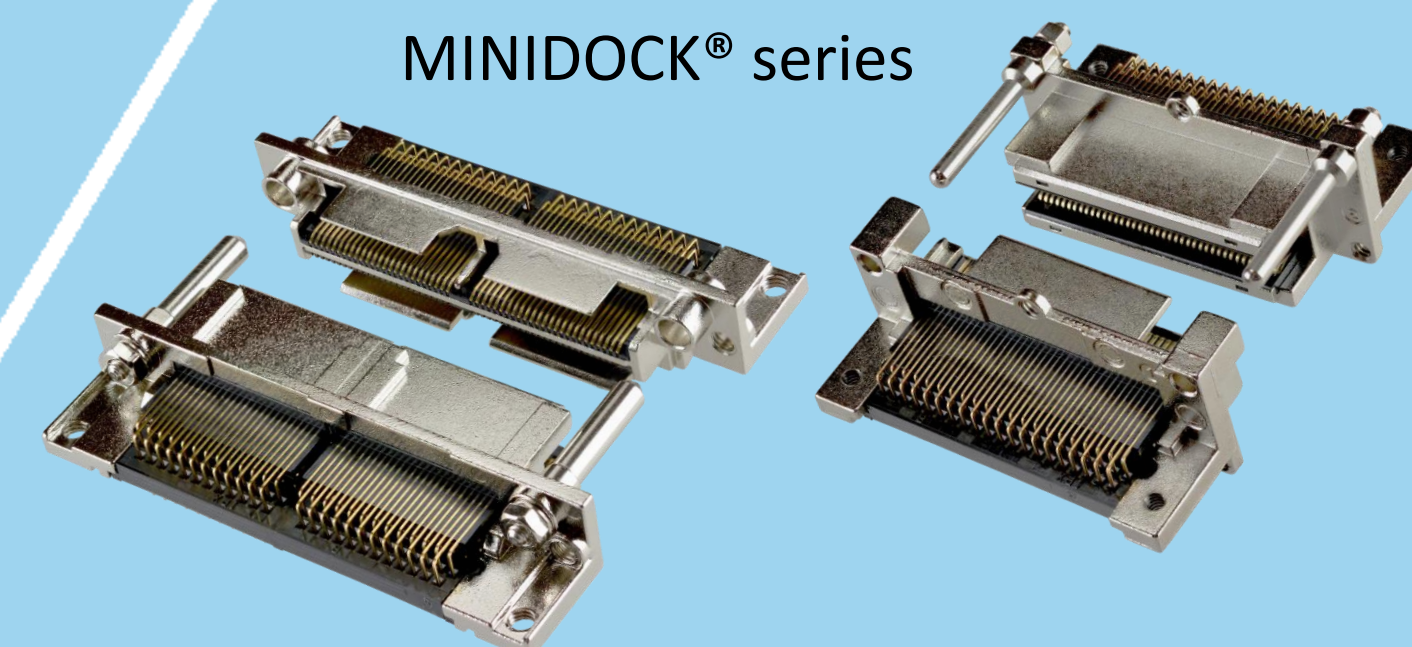

I-PEX, MHF, CABLINE, LIGHTPASS, NOVASTACK, ISH, IARPB, MINIFLEX, EVAFLEX, MINIDOCKS and ZenShield are registered trademarks of I-PEX Inc. Please note that the contents in the catalog might be changed without prior notification. I-PEX Inc. assumes no responsibility for any inaccuracies or obligation to update information on these documents. Please be sure to read and understand the latest "Precautions for Use" and "Instruction Manual" before you use our products. We shall not be responsible for any defects, damages or troubles in case you use our products without following the precautions for use. Please feel free to contact our sales representatives when you use our products for any applications that require very high reliability and safety, or that relate to human life (ex. nuclear power control, aerospace, transportation, medical equipment, safety equipment etc.).

Contact your sales representative or more detailed information.

www.i-pex.com

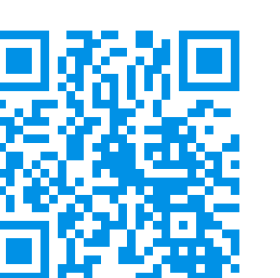

I-PEX

© I-PEX Inc. 2024
All rights reserved