

MINIFLEX® 5-FF

Hold down款式的坚固设计，高度= 2.55 mm，0.5 mm间距,水平插拔,前锁式

Product Specifications:

Board Pitch (mm)	0.5	
Wiping Length (mm)	1.40	
Size (mm)	Height	2.55 +/- 0.2
	Width	Formula: 4.9+(0.5*?p)
	Depth	Open: 6.4 Close: 7.2
Pin counts	Range	10-80 (even)
	Available	20, 30, 40, 50, 55, 60, 64, 68

Applicable FPC/FFC:

FPC/FFC Contact Pitch	0.5
FPC/FFC Contact Point	Bottom
FPC/FFC Thickness (mm)	0.3 +/- 0.05

*如您需要了解未列出或不在范围内的Pin数，请咨询我们。



▶ 两侧设计有金属补强机构，加强侧壁强度，也能防止钢琴盖脱落

金属补强部分维持钢琴盖

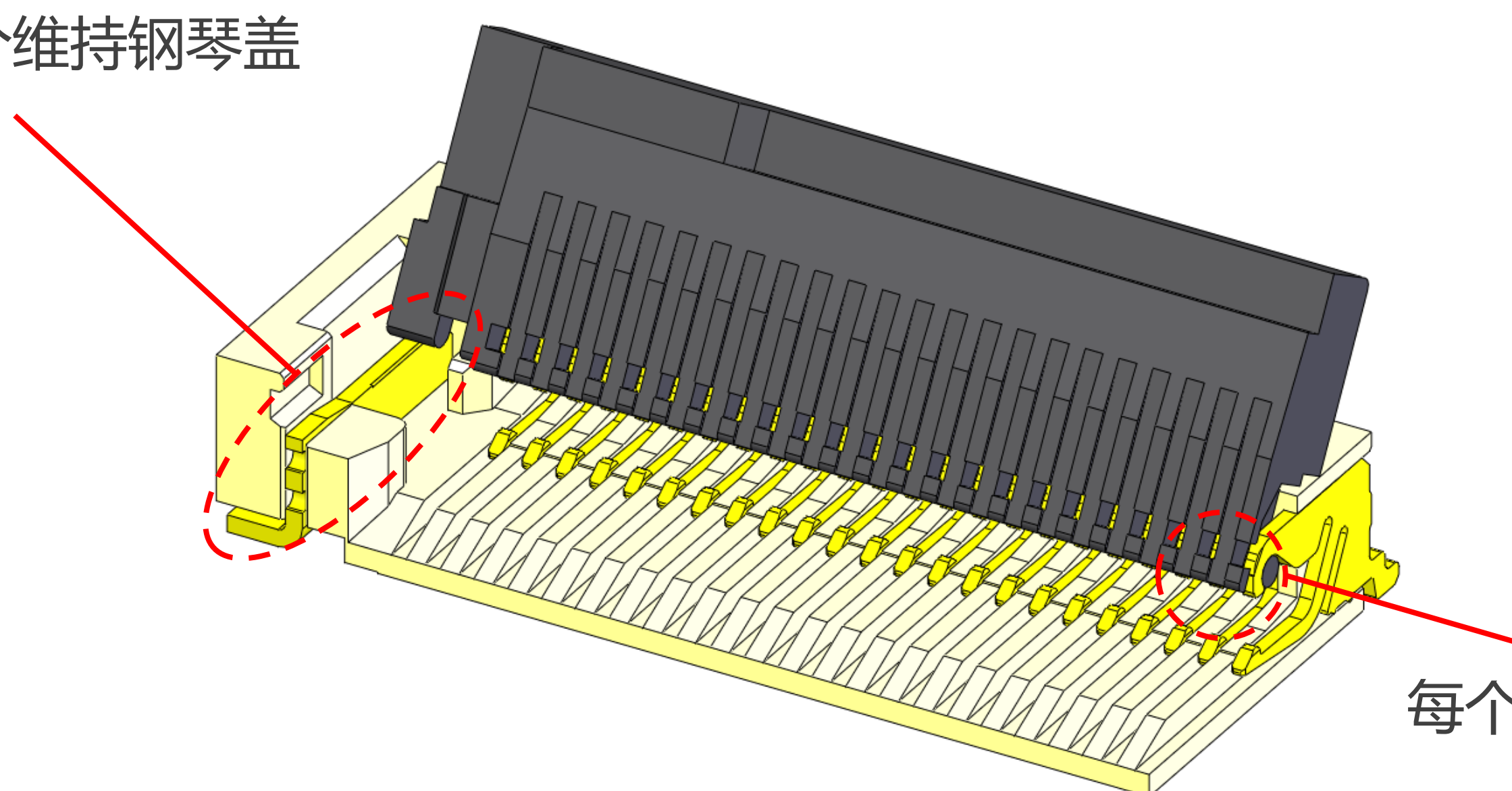

每个端子的头部也维持钢琴盖

▶ 钢琴盖上的小突起防止钢琴盖意外打开

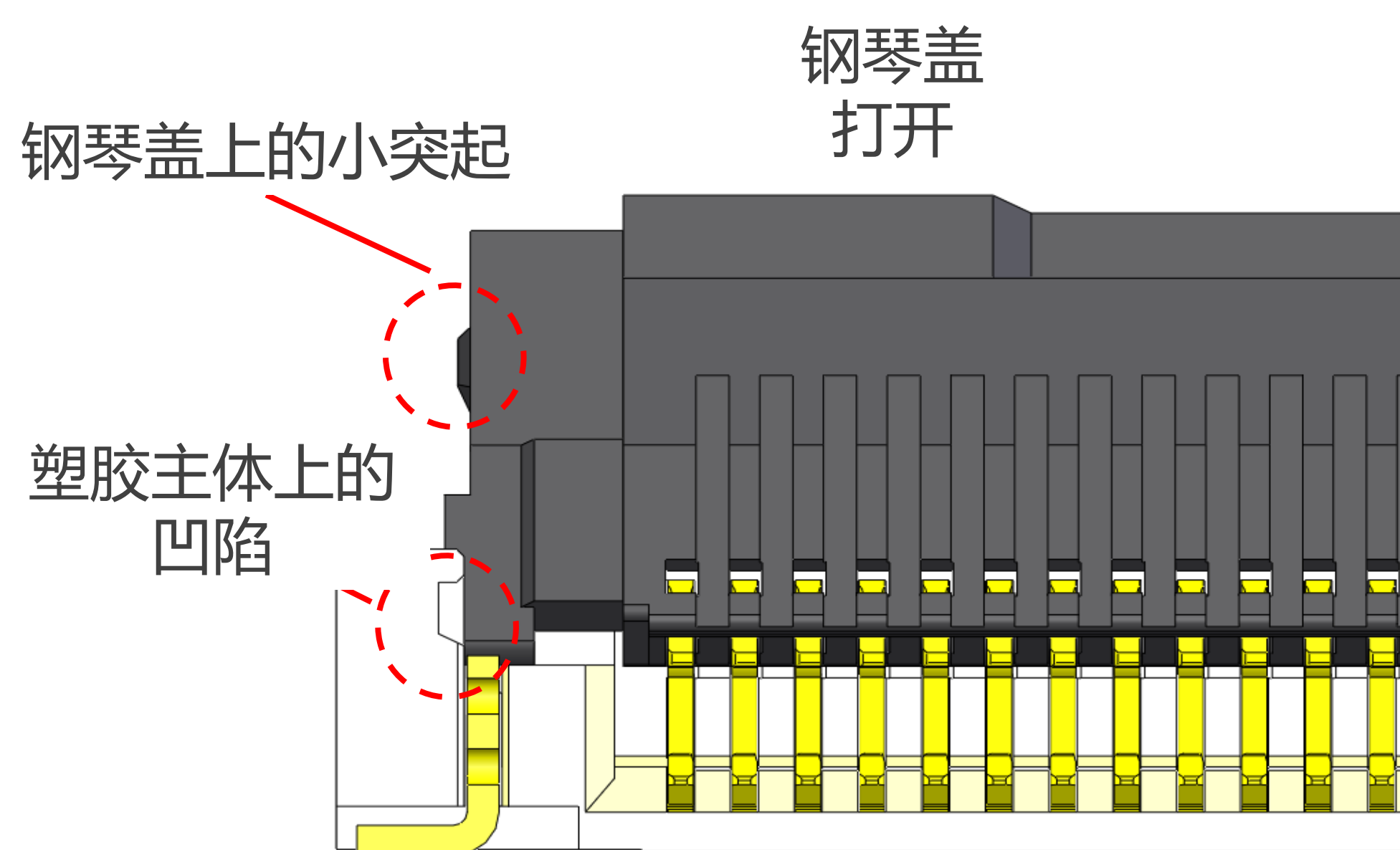

钢琴盖
打开

钢琴盖
闭合

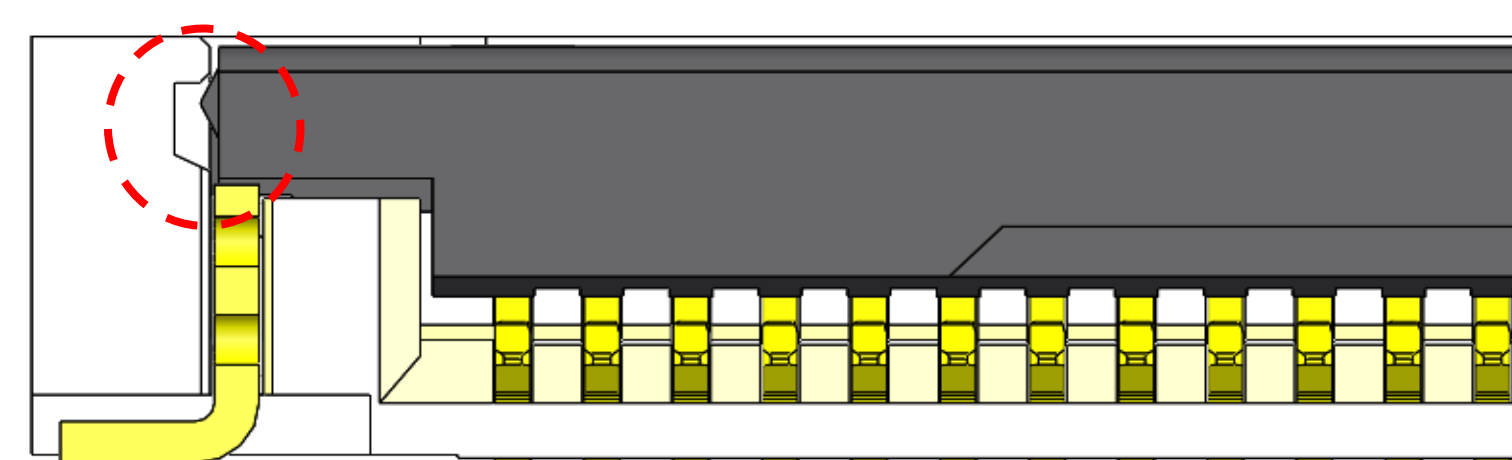

▶ FPC/FFC的形状可以根据需要选择-有或者没有突起

两侧带有突起的FPC/FFC

插入前

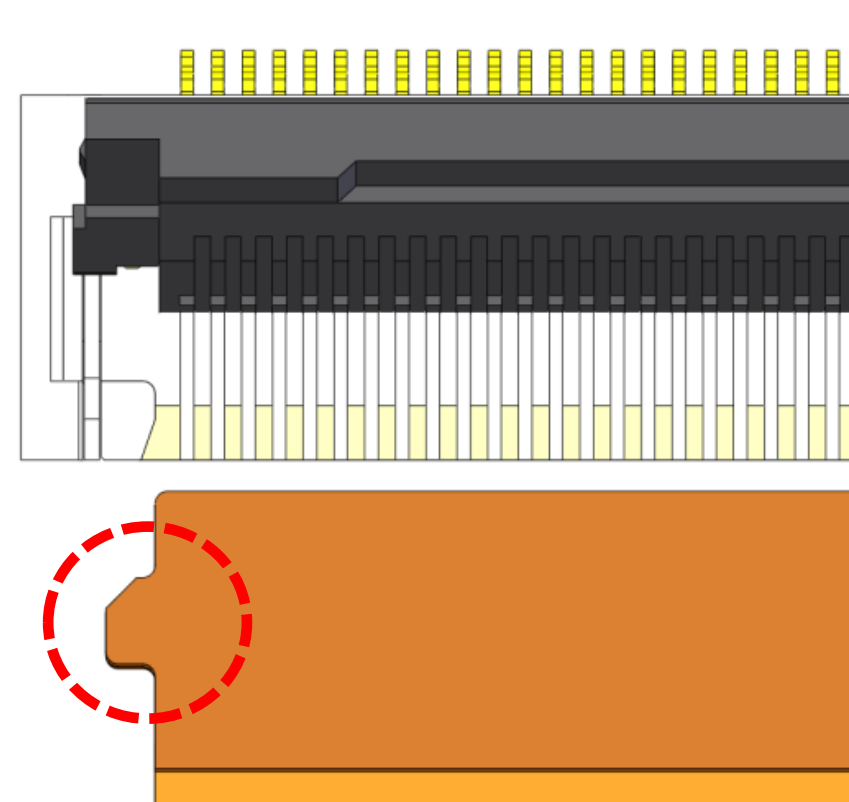

插入后

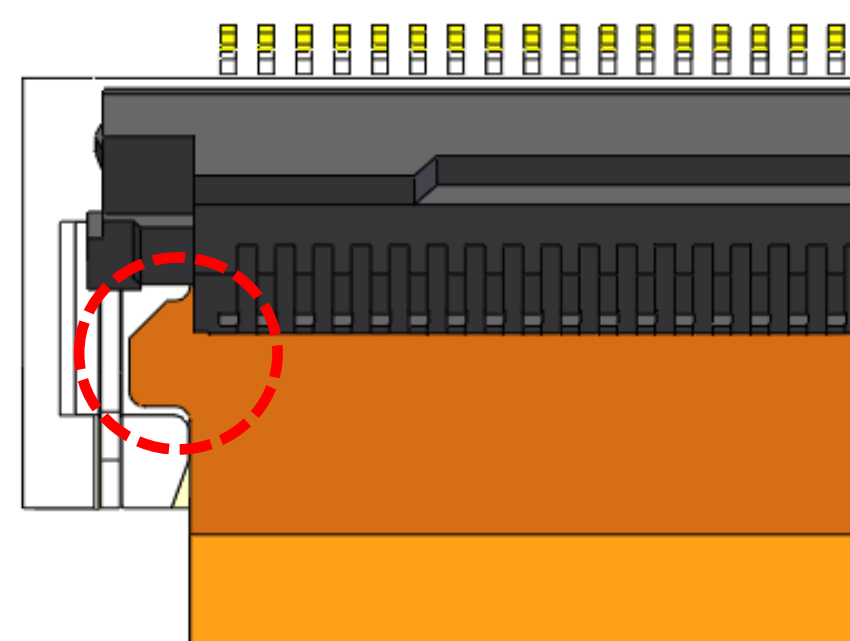

两侧没有突起的FPC/FFC

插入前

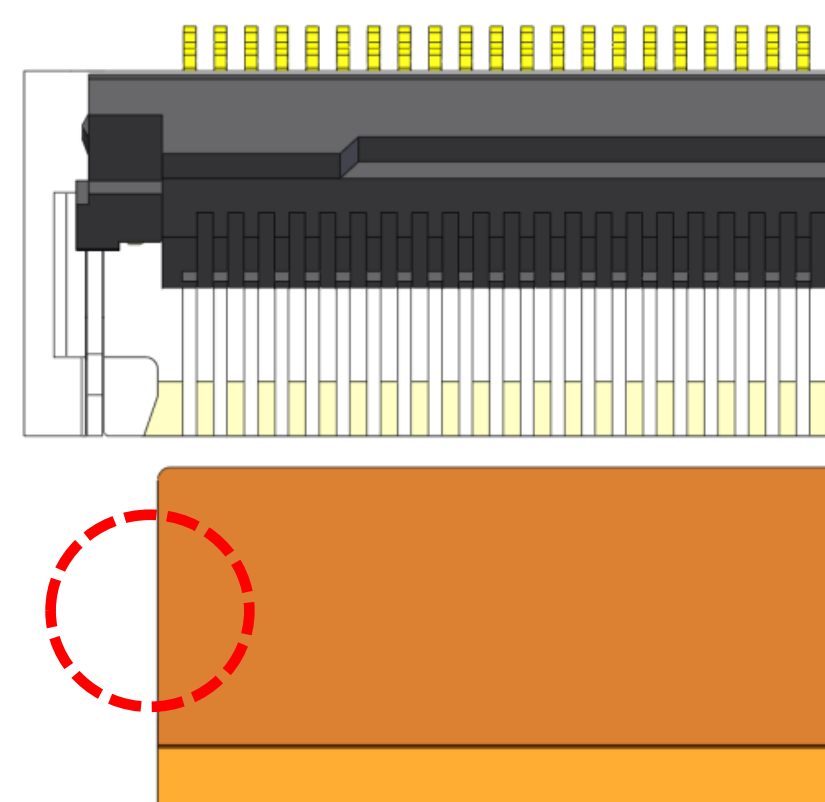

插入后

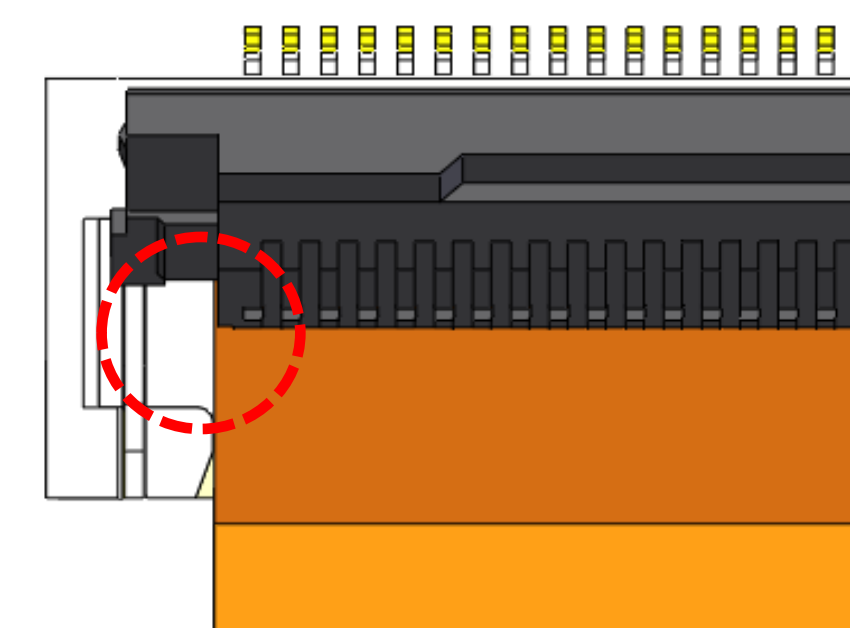

Component Parts Details

Connector Assembly

Recommended P/N		20647-0**E-01			
PART No.	Pos.	A	B	C	D
20647-020E-01	20P	9.50	14.90	10.57	14.58
20647-030E-01	30P	14.50	19.90	15.57	19.58
20647-040E-01	40P	19.50	24.90	20.57	24.58
20647-050E-01	50P	24.50	29.90	25.57	29.58
20647-055E-01	55P	27.00	32.40	28.07	32.08
20647-060E-01	60P	29.50	34.90	30.57	34.58
20647-064E-01	64P	31.50	36.90	32.57	36.58
20647-068E-01	68P	33.50	38.90	34.57	38.58

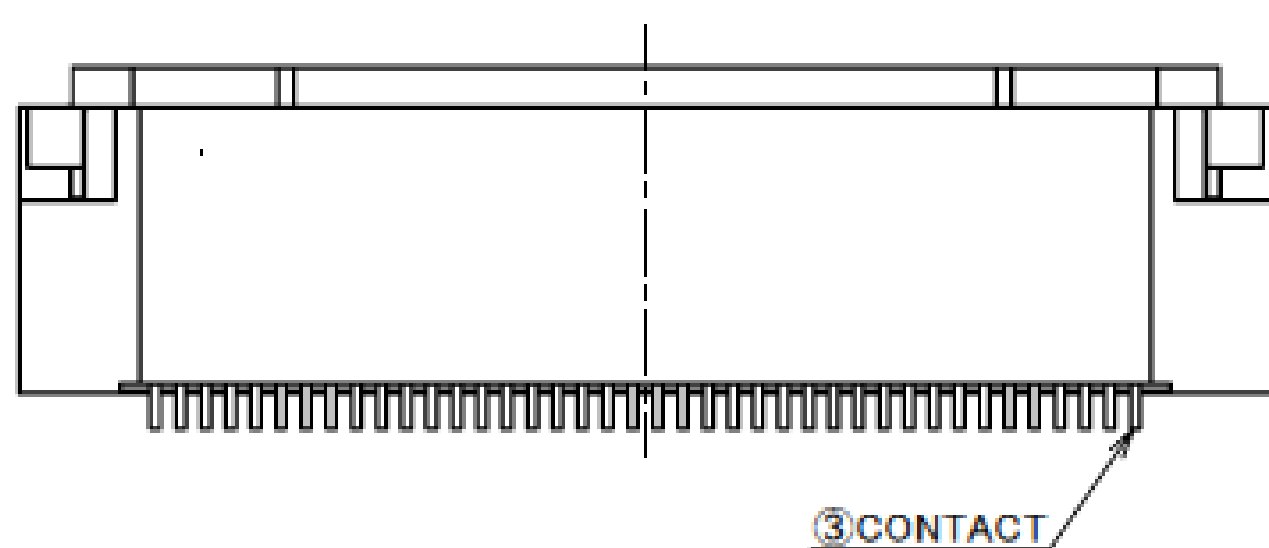
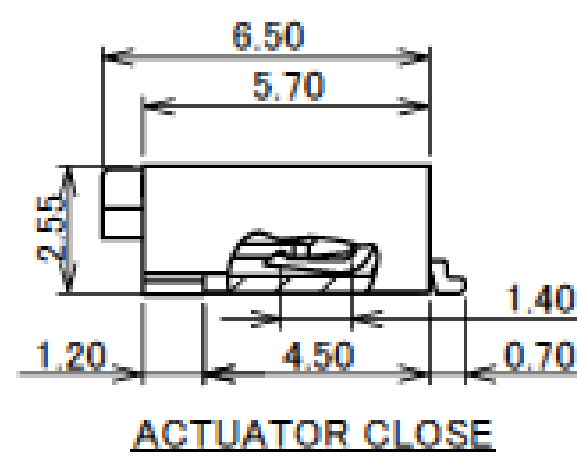
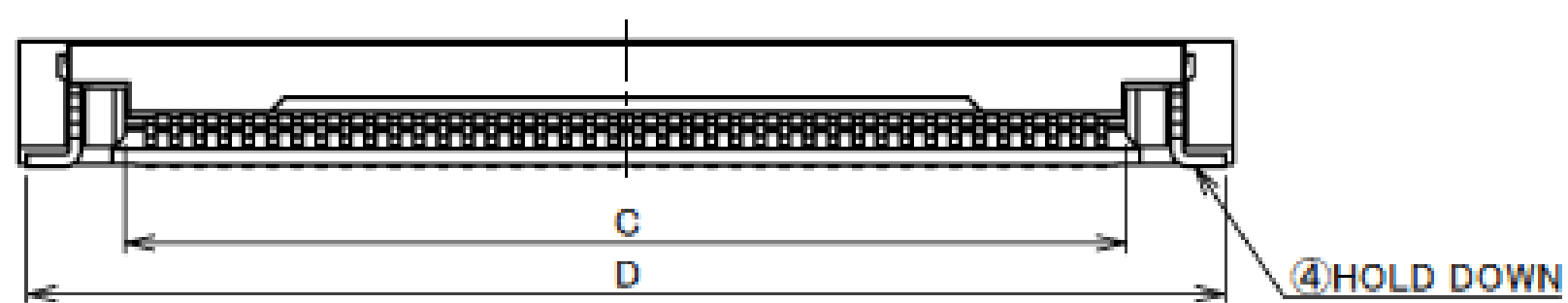
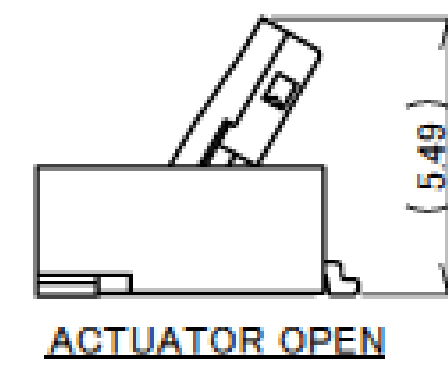
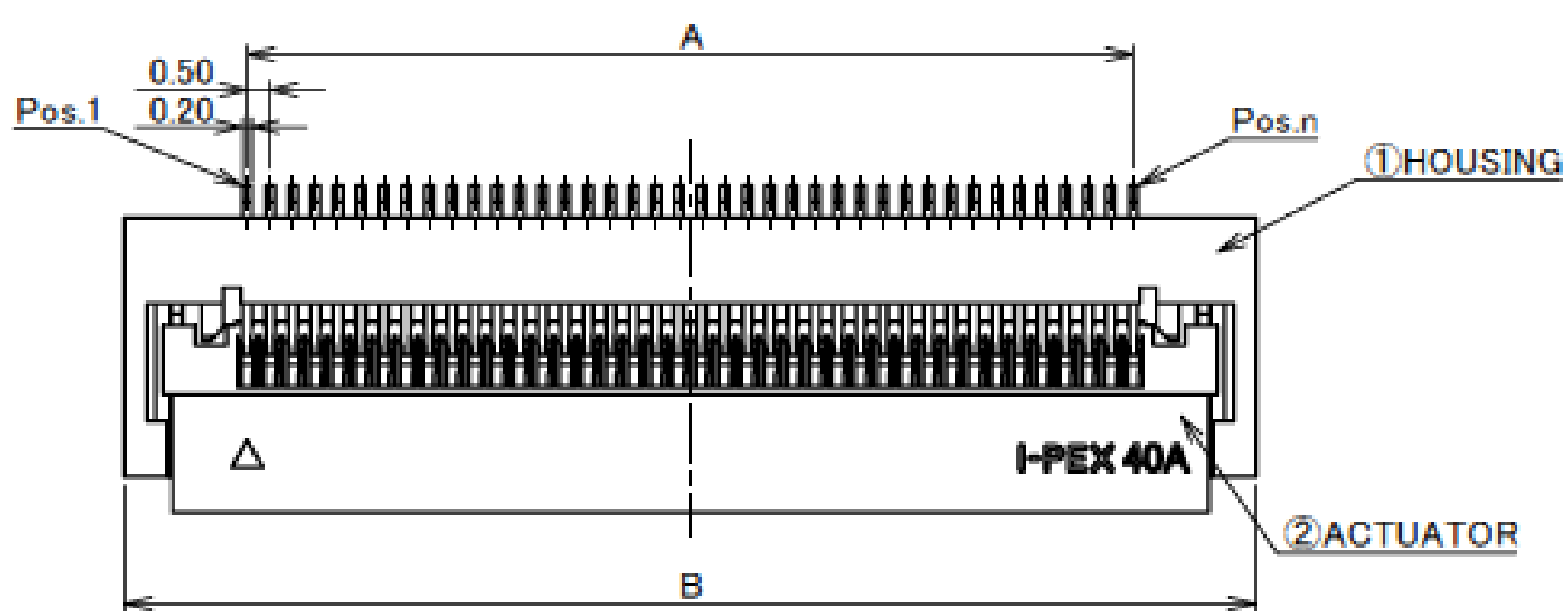
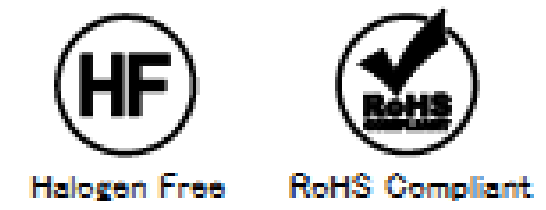

4	HOLD DOWN	COPPER ALLOY	SOLDERING AREA : Au 0.02 μm MIN. OVER Ni 1.00 μm MIN.
3	CONTACT	COPPER ALLOY	CONTACT AREA : Au 0.03 μm MIN. OVER Ni 1.00 μm MIN. SOLDERING AREA : Au 0.03 μm MIN. OVER Ni 1.00 μm MIN.
2	ACTUATOR	LCP	UL94V-0 BLACK
1	HOUSING	LCP	UL94V-0 BEIGE
NO.	DISCRIPTION	MATERIAL	FINISH , REMARKS

Connector Assembly

Pos.	A	E	F	G	H
20P	9.50	12.00	15.60	12.10	10.50
30P	14.50	17.00	20.60	17.10	15.50
40P	19.50	22.00	25.60	22.10	20.50
50P	24.50	27.00	30.60	27.10	25.50
55P	27.00	29.50	33.10	29.60	28.00
60P	29.50	32.00	35.60	32.10	30.50
64P	31.50	34.00	37.60	34.10	32.50
68P	33.50	36.00	39.60	36.10	34.50

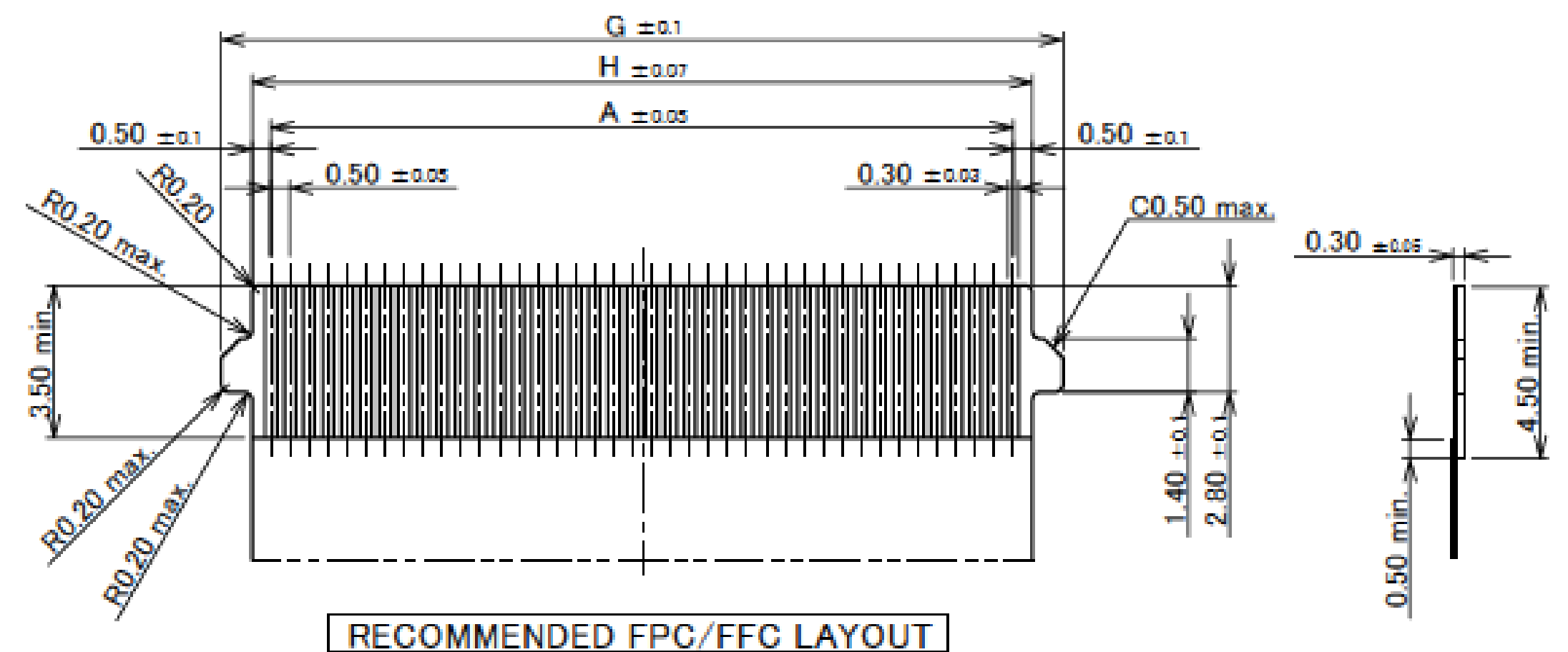
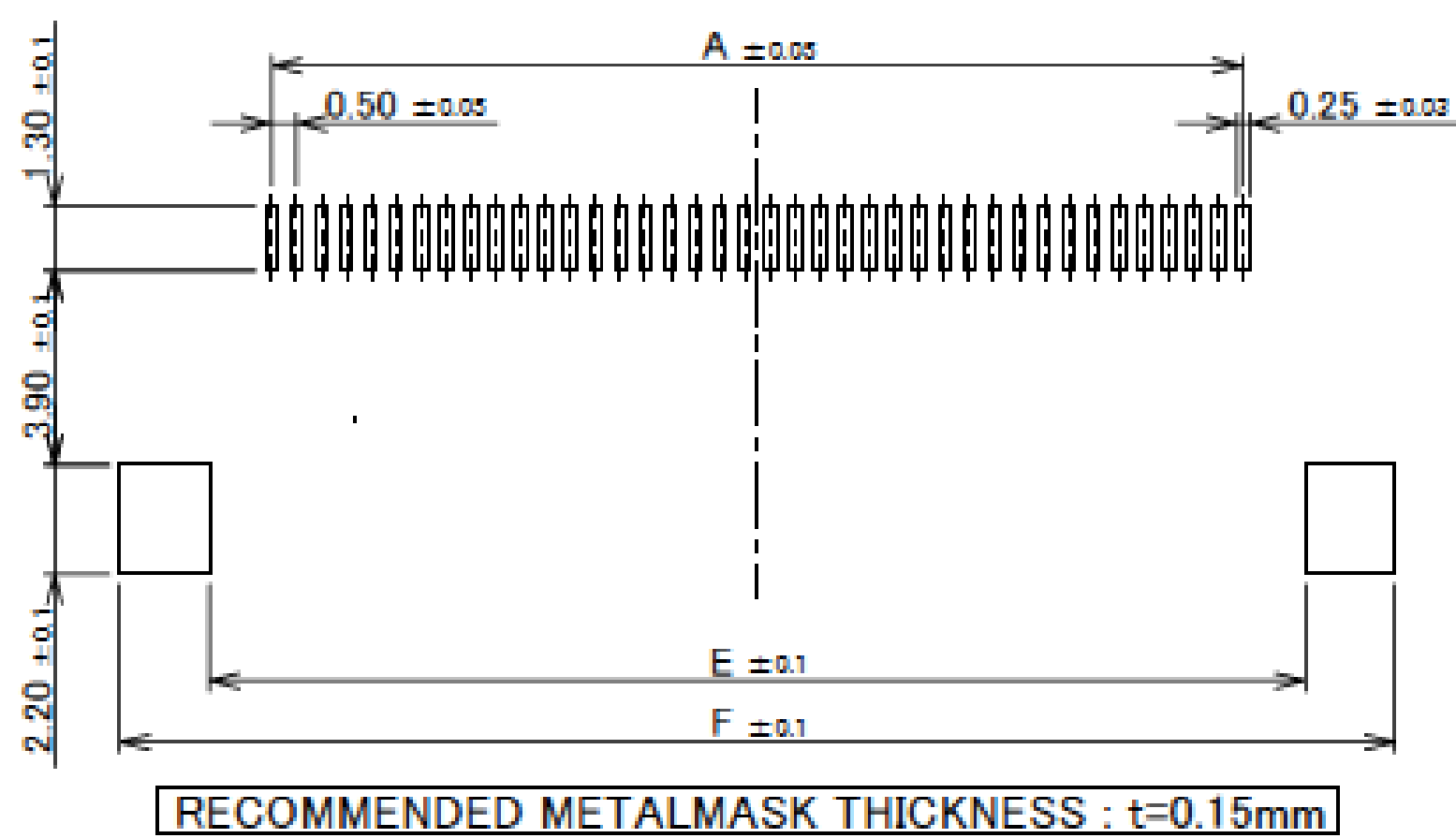
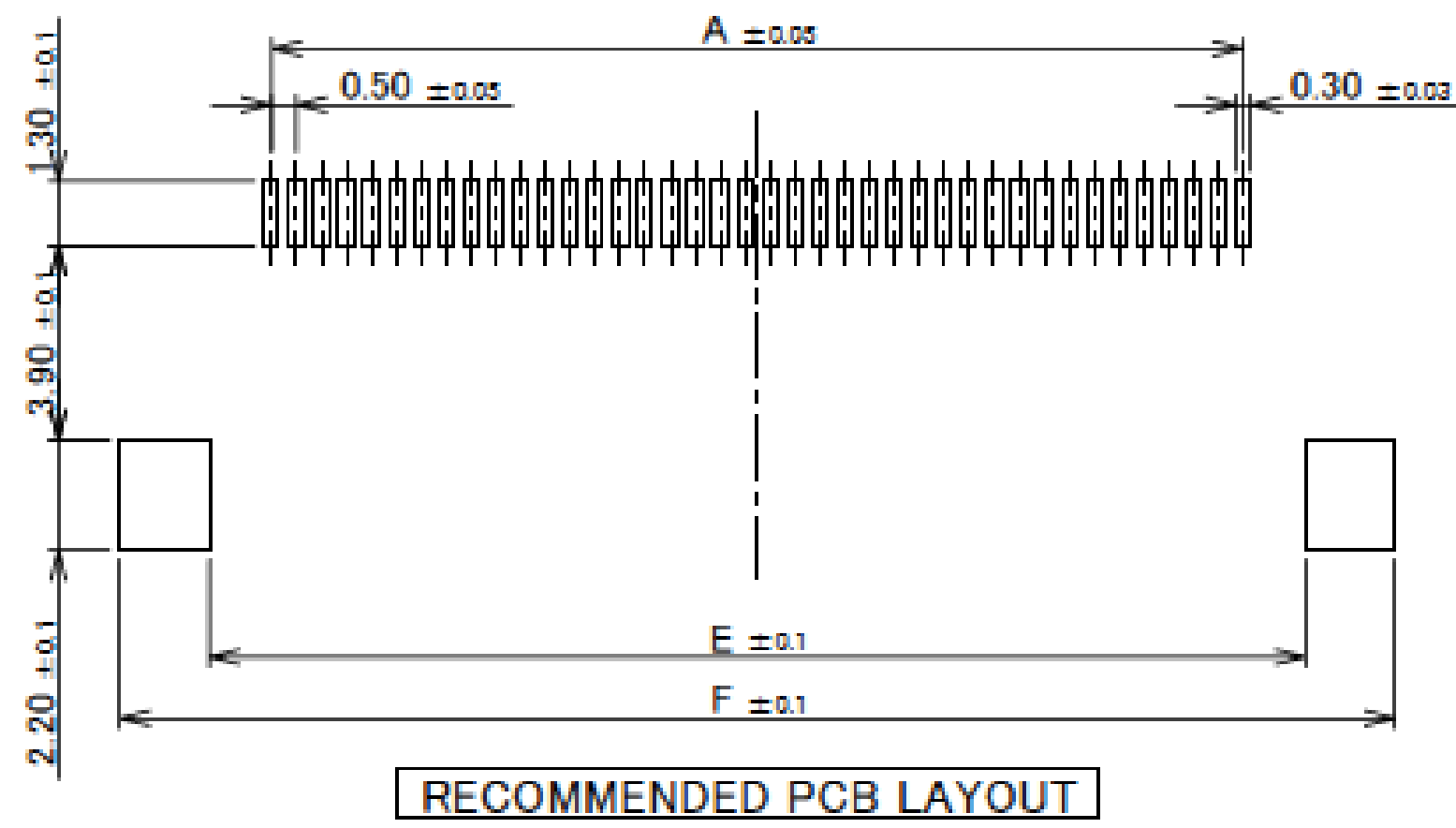

- NOTES**
- 1.MATERIAL**
 - COVER FILM : PI
 - CONDUCTOR : COPPER
 - BASE FILM : PI
 - STIFFENER : PI
 - ADHESIVE : THERMOSETTING ADHESIVE
 - 2.FINISH**
 - Au OVER Ni UNDER PLATING

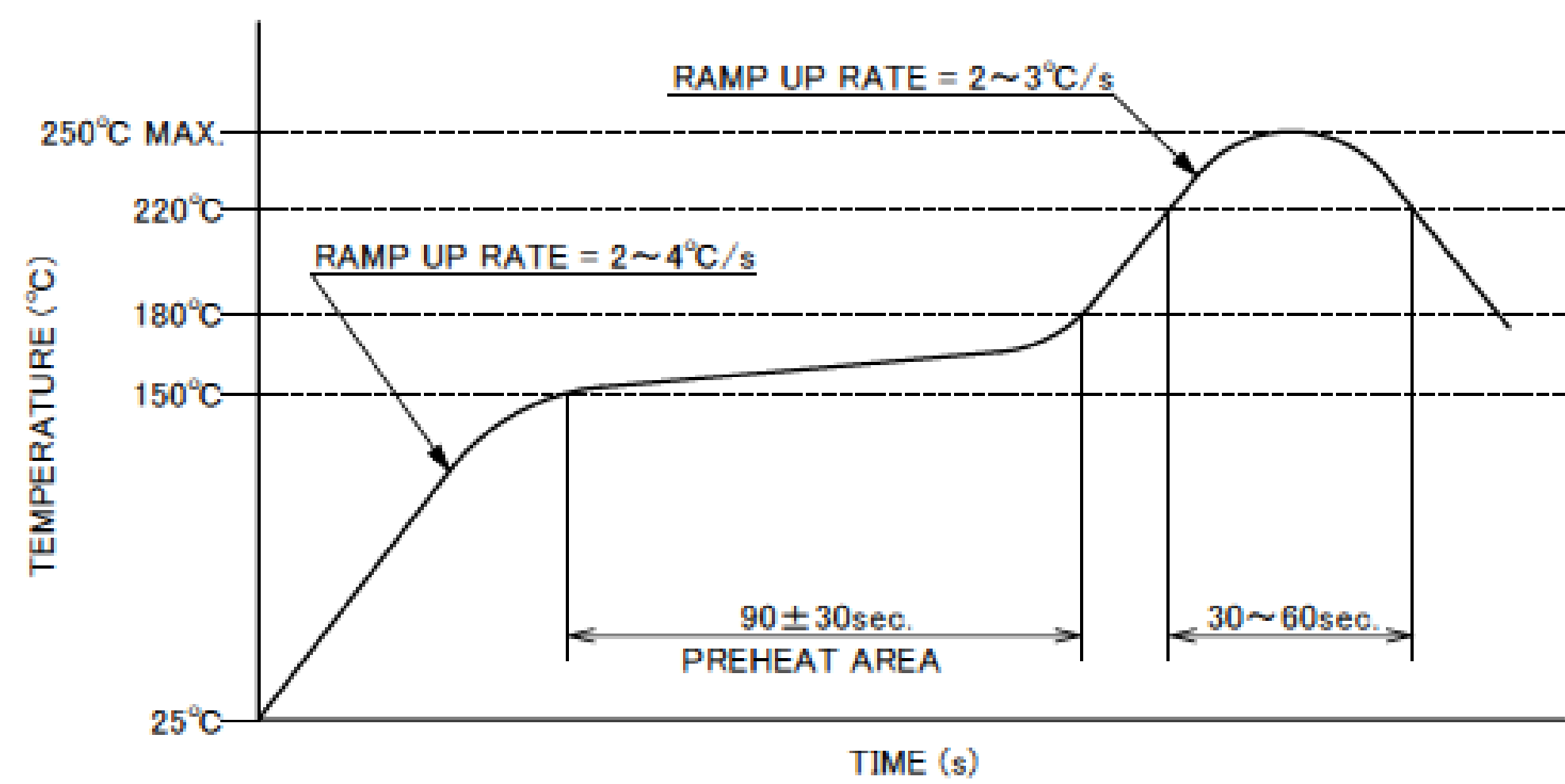
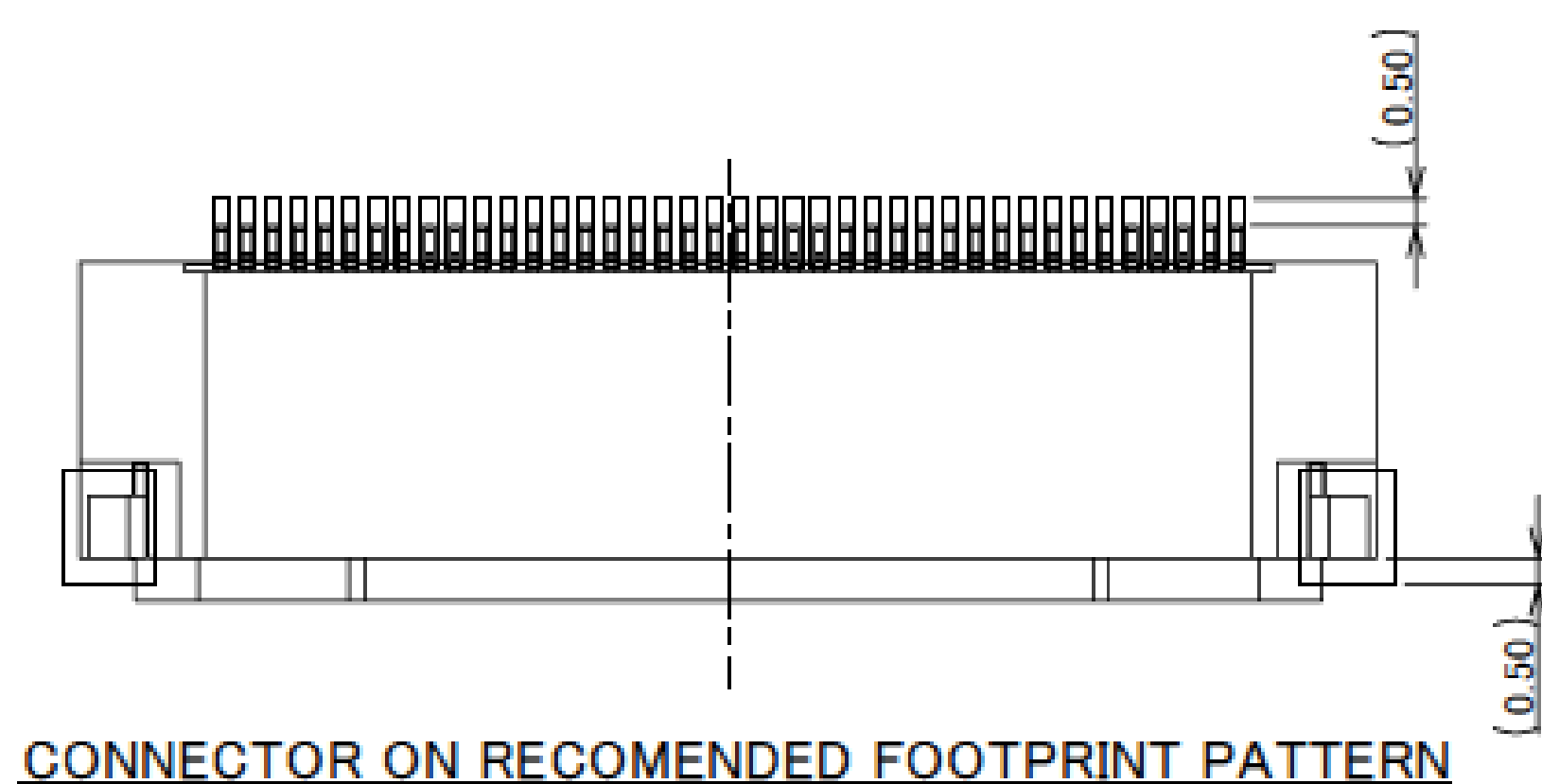

Rev.12

Rev.12

Plug for Cable Assembly

ITEMS	SPECIFICATION
RATING VOLTAGE	50V AC (PER CONTACT PIN)
RATING AMPERAGE (FOR CONTACT)	0.5A DC (PER CONTACT PIN) / 0.35A DC(AVAILABLE FOR ALL PIN)
OPERATING TEMPERATURE	233~378K(-40°C~+105°C)
OPERATING HUMIDITY	90% MAX.(NON-CONDENSING)
CONTACT RESISTANCE (FOR CONTACT)	INITIAL : 40mohm MAX. / AFTER TEST : \leq20mohm MAX.
INSULATION RESISTANCE	INITIAL : 500Mohm MIN. / AFTER TEST : 500Mohm MIN.
DIELECTRIC WITHSTANDING VOLTAGE	AC200V 1min
DURABILITY	20 CYCLES
CABLE RETENTION FORCE	20P : 8.0N MIN.
	30P : 12.0N MIN.
	40P : 16.0N MIN.
	50P : 20.0N MIN.
	55P : 22.0N MIN.
	60P : 24.0N MIN.
	64P : 25.6N MIN.
68P : 27.2N MIN.	
PRODUCT SPECIFICATION	PRS-2039
TEST REPORT	TR-14129
PACKING STANDARD	PST-14086
INSTRUCTION MANUAL	HIM-15007
APPEARANCE CRITERIA No.	QLS-A***

Rev.12

Custom Connectors Available

 RF Connector

MHF® series



 CABLINE® series
Micro-coaxial/Twinax/
Discrete Wire Connector

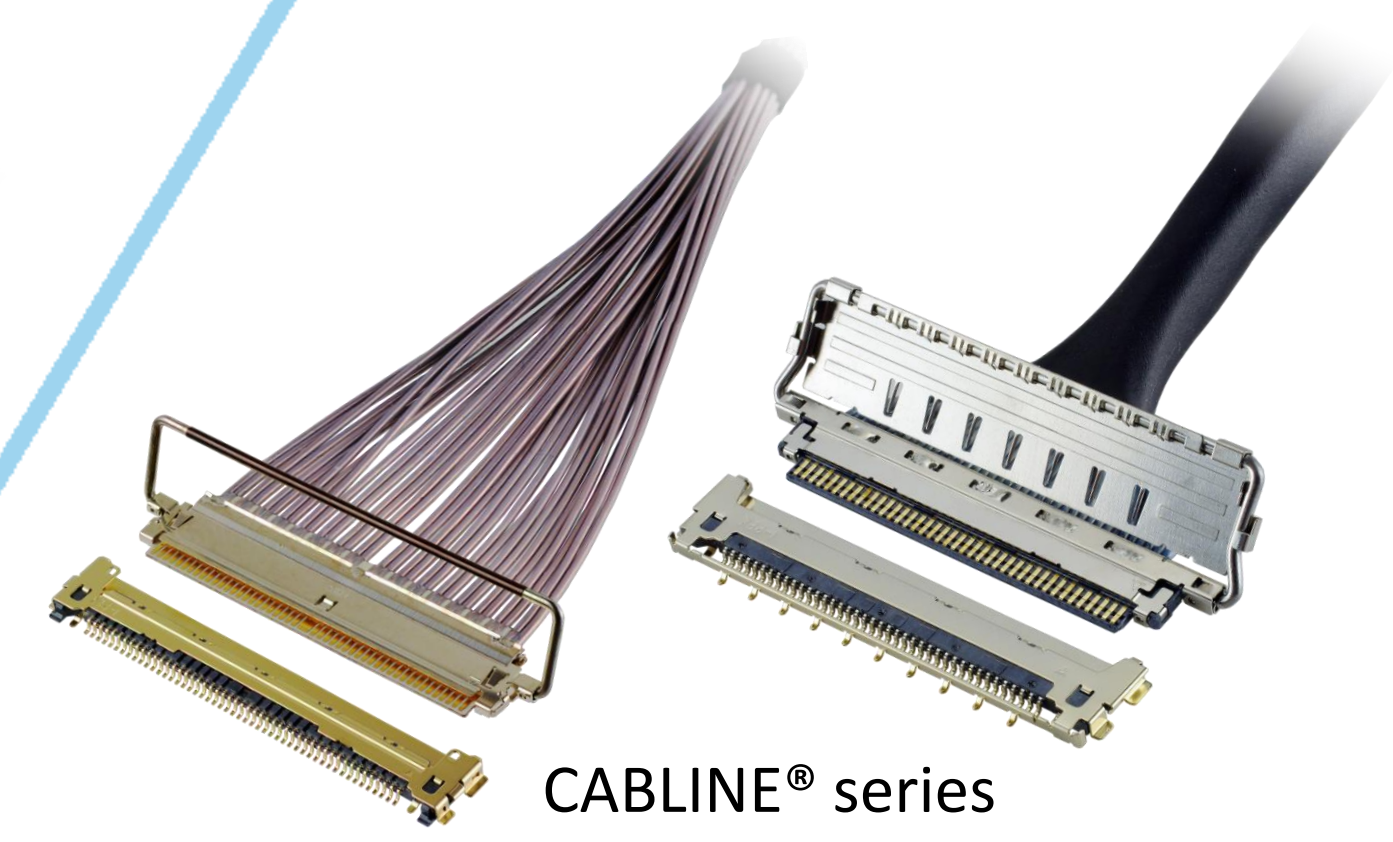

 Optical Module

LIGHTPASS® series



NOVASTACK® series

 Board-to-Board Connector

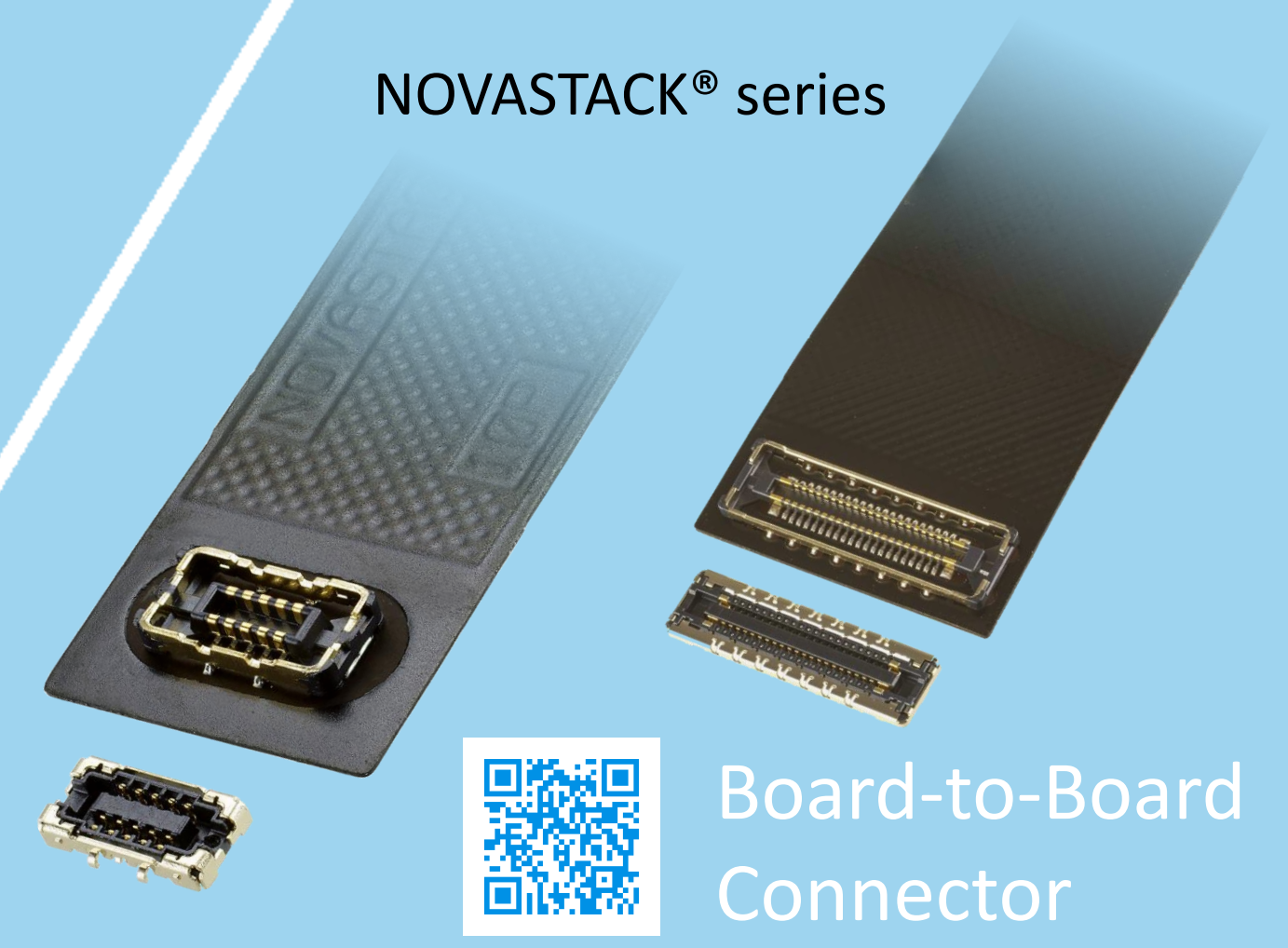

 Power Connector/
Terminal

AP series

ISH® series



MINIFLEX® series

EVAFLEX® series

 FPC FFC Connector



Inquiry



MINIDOCK® series

 I/O Connector

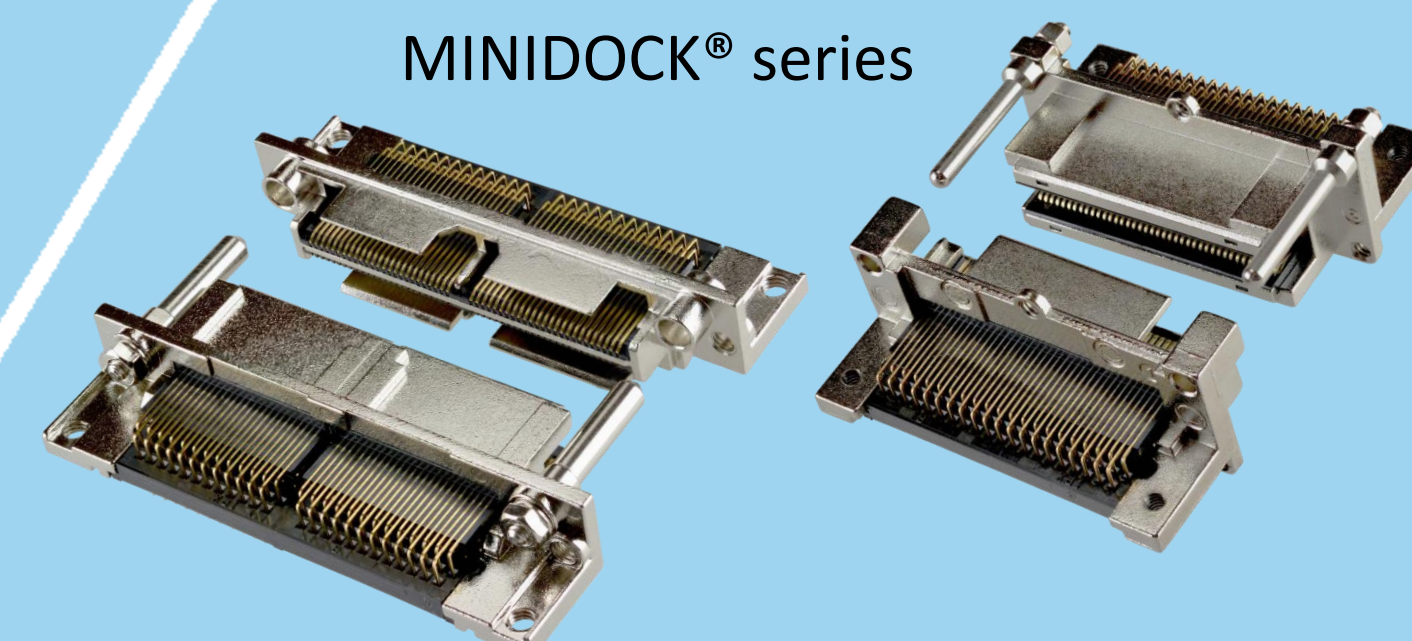

I-PEX, MHF, CABLINE, LIGHTPASS, NOVASTACK, ISH, IARPB, MINIFLEX, EVAFLEX, MINIDOCKS and ZenShield are registered trademarks of I-PEX Inc. Please note that the contents in the catalog might be changed without prior notification. I-PEX Inc. assumes no responsibility for any inaccuracies or obligation to update information on these documents. Please be sure to read and understand the latest "Precautions for Use" and "Instruction Manual" before you use our products. We shall not be responsible for any defects, damages or troubles in case you use our products without following the precautions for use. Please feel free to contact our sales representatives when you use our products for any applications that require very high reliability and safety, or that relate to human life (ex. nuclear power control, aerospace, transportation, medical equipment, safety equipment etc.).

Contact your sales representative or more detailed information.

www.i-pex.com



I-PEX

© I-PEX Inc. 2024
All rights reserved