

MHF® I LK

Locking solution that works with MHF I receptacles, supports up to 9 GHz, mated height of 2.9 mm max

Product Specifications:

Mated Height (mm max.)	2.9		
Rece. SMT Size (mm)	3.0 x 3.0		
Applicable Frequency	DC ~ 9 GHz		
Characteristic Impedance	50 ohm		
VSWR (L=100 mm)	Connector	PLUG	RECEPTACLE
	DC~3 GHz	1.3 max.	1.3 max.
	3~6 GHz	1.5 max.	1.4 max.
	6~9 GHz	1.9 max.	1.8 max.

Applicable Cable Size:

O.D. 1.80 mm / AWG 30
O.D. 1.37 mm / AWG 30
O.D. 1.32 mm / AWG 32
O.D. 1.13 mm / AWG 32
O.D. 0.81 mm / AWG 36

Applicable Standards (Reference Only):

5G sub-6, Wi-Fi 6E, LTE/LTE-Advanced, LPWA, Bluetooth, GPS



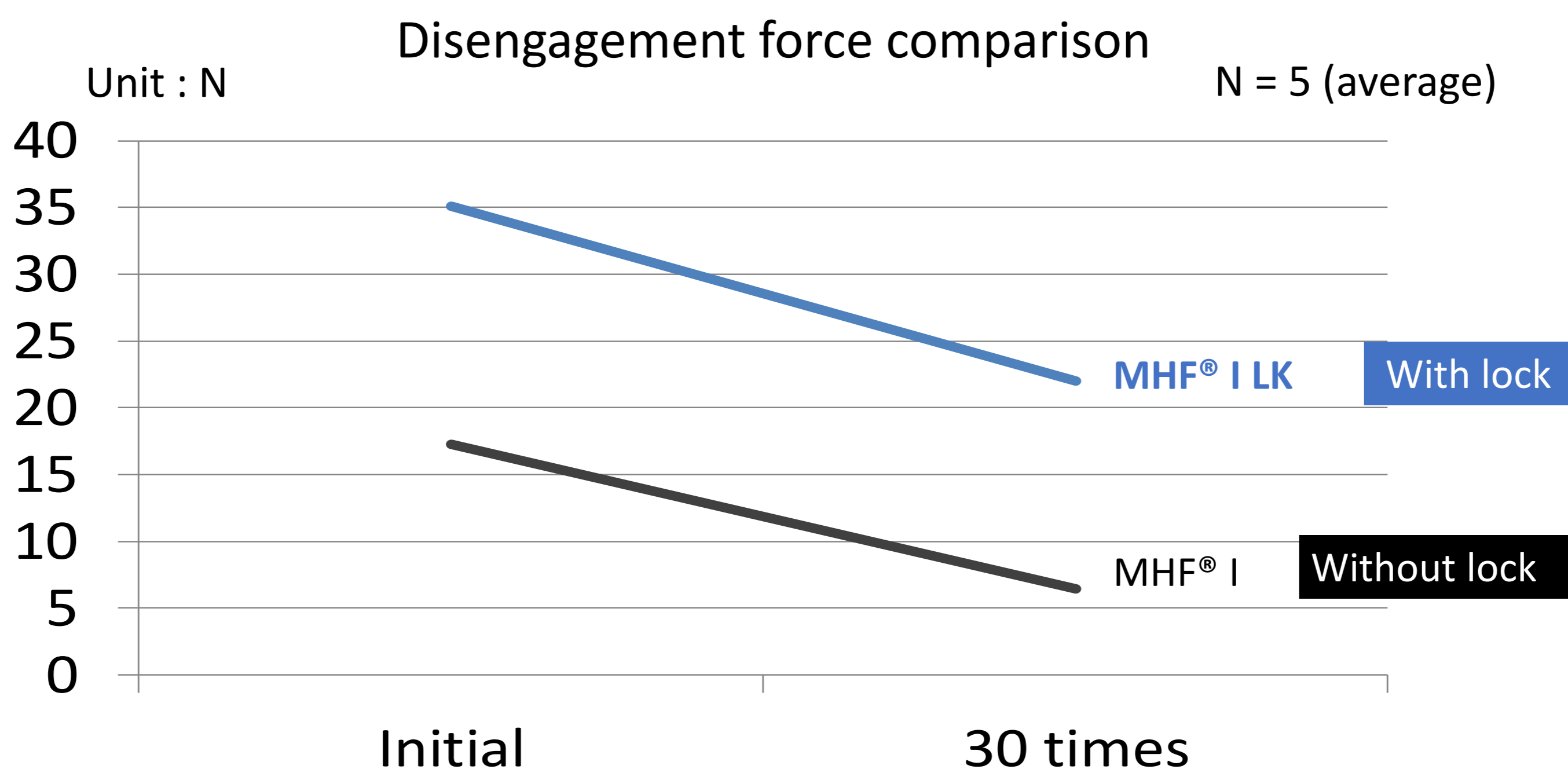

▶ **Ideal for continuous shock and vibration applications**

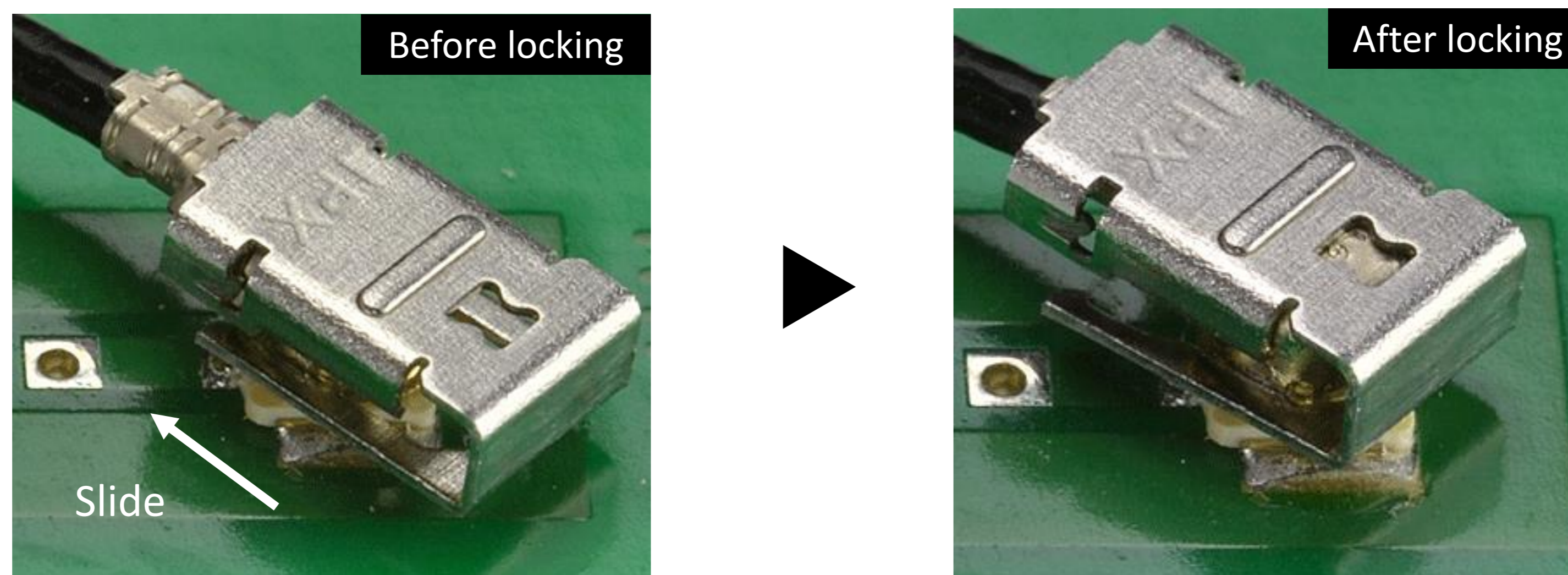

▶ **Patented locking system for MHF® I plug**

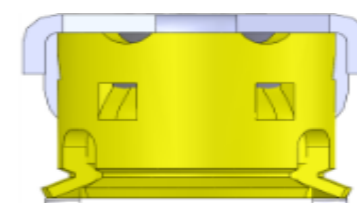

▶ **Mates with all MHF® I receptacles**

			
Product name	MHF® I LK	MHF® I	MHF® I
Lock	With Lock	Without Lock	Without Lock
Mating Height	2.9 mm max.	2.5 mm max.	3.0 mm max.
Coax O.D. (Center Conductor AWG)	2.00 mm (AWG#26)		●
	1.80 mm (AWG#30)	●	
	1.37 mm (AWG#30)	●	●
	1.32 mm (AWG#32)	●	●
	1.13 mm (AWG#32)	●	●
	0.81 mm (AWG#36)	●	●
Receptacle	MHF® I receptacle 20279-001E-** (3 pads) / 20441-001E-01 (4 pads)		

Component Parts Details

MHF® I LK

Cable : $\Phi 0.81$ mm

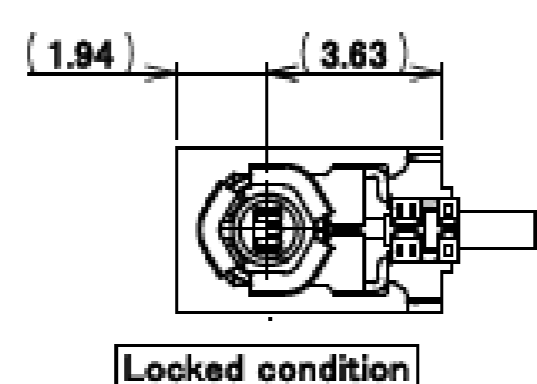
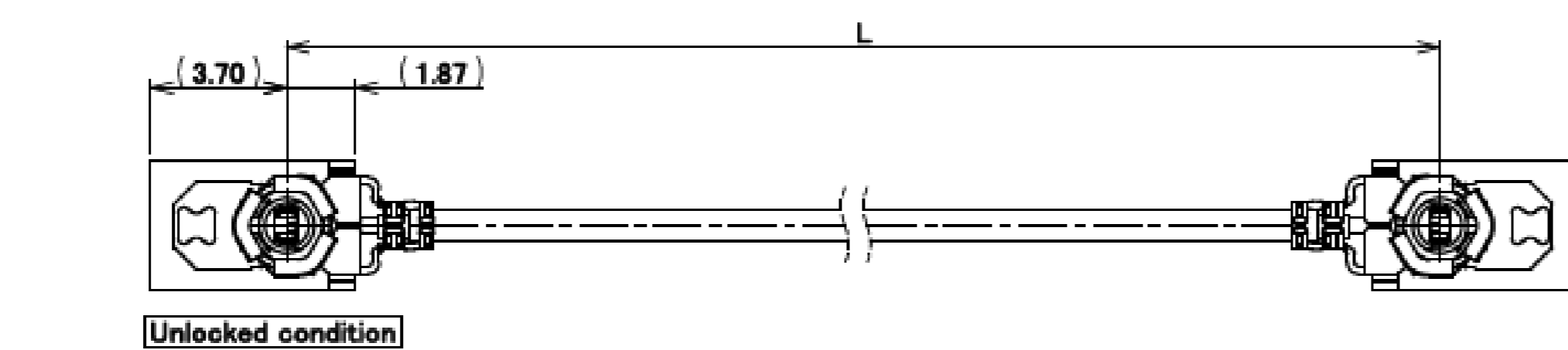
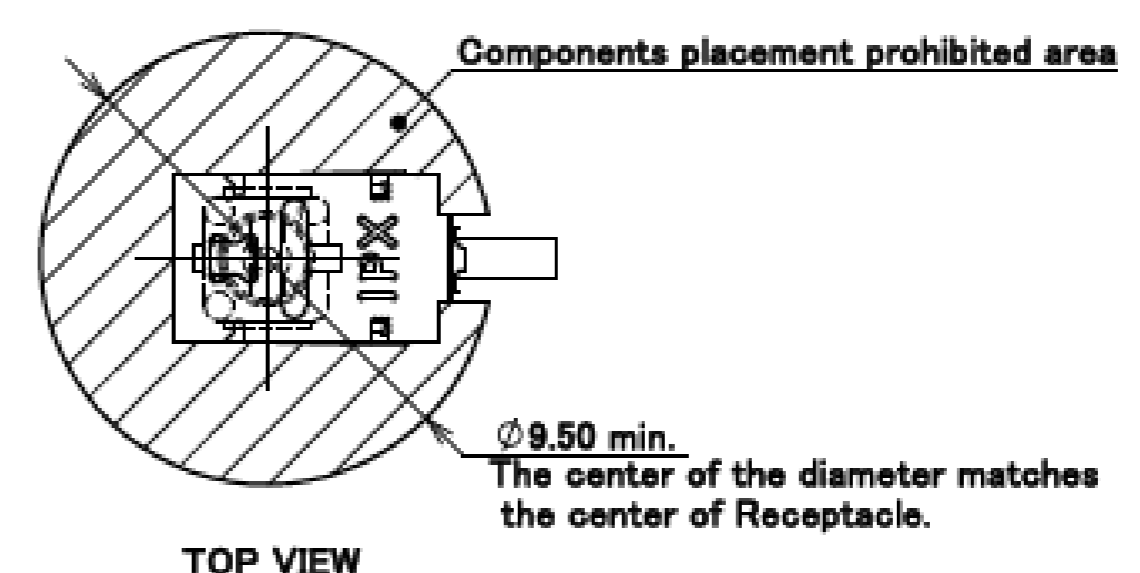
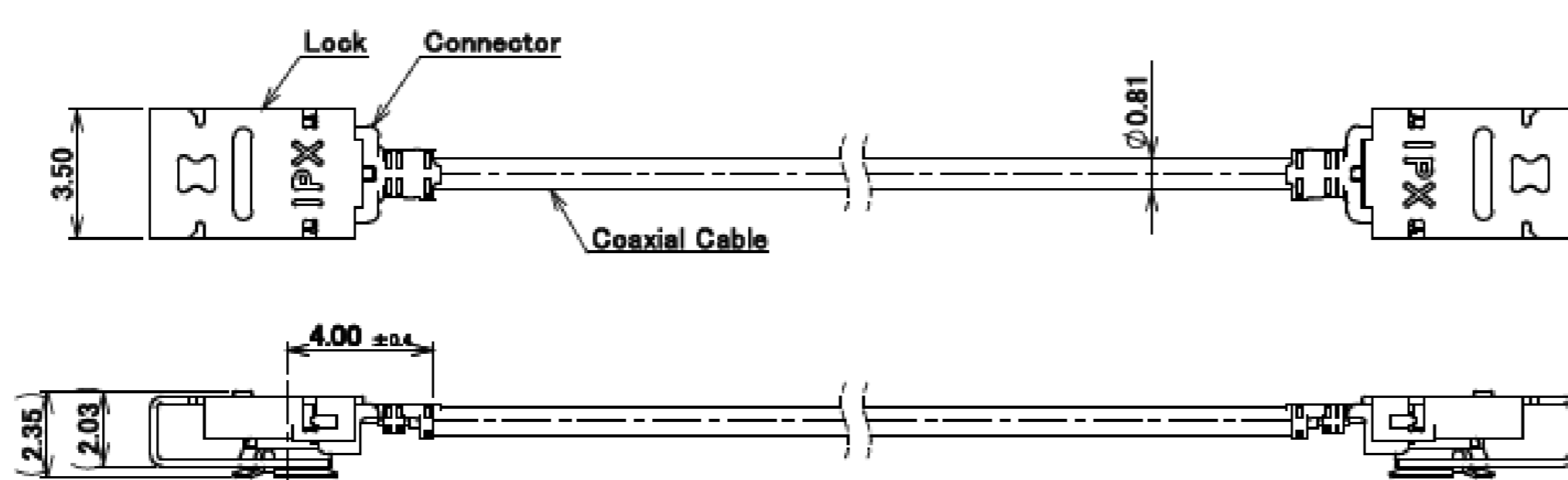

• Don't be mating with the receptacle when this condition.

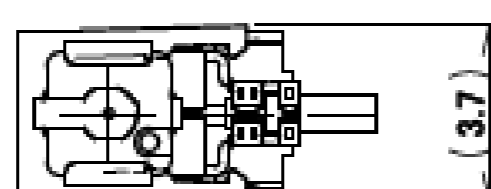

• The dimensions of lock bottom width when mating with receptacle and locked.

BOTTOM VIEW

NOTES

1. Constructions
 - (1) Connector : MHF I Plug, Ni-TOP
 - (2) Coaxial cable : AWG#36 $\Phi 0.81$
 - (3) Lock part
2. Orientation of connector : $0^\circ \pm 45^\circ$
3. Packing : Bag
4. This product is RoHS compliant.
5. Cable crimp strength : 10N MIN.
6. Permissible load of cable at mating.

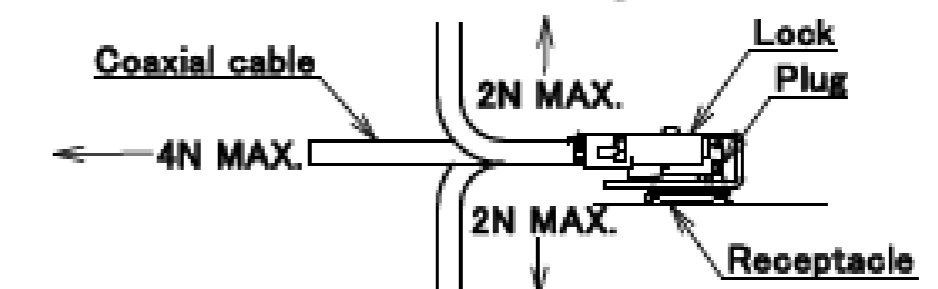

7. To handle lock parts
You must read and follow the instruction manual below.
I-PEX instruction manual No. HIM-17020

Cable : $\Phi 1.13$ mm

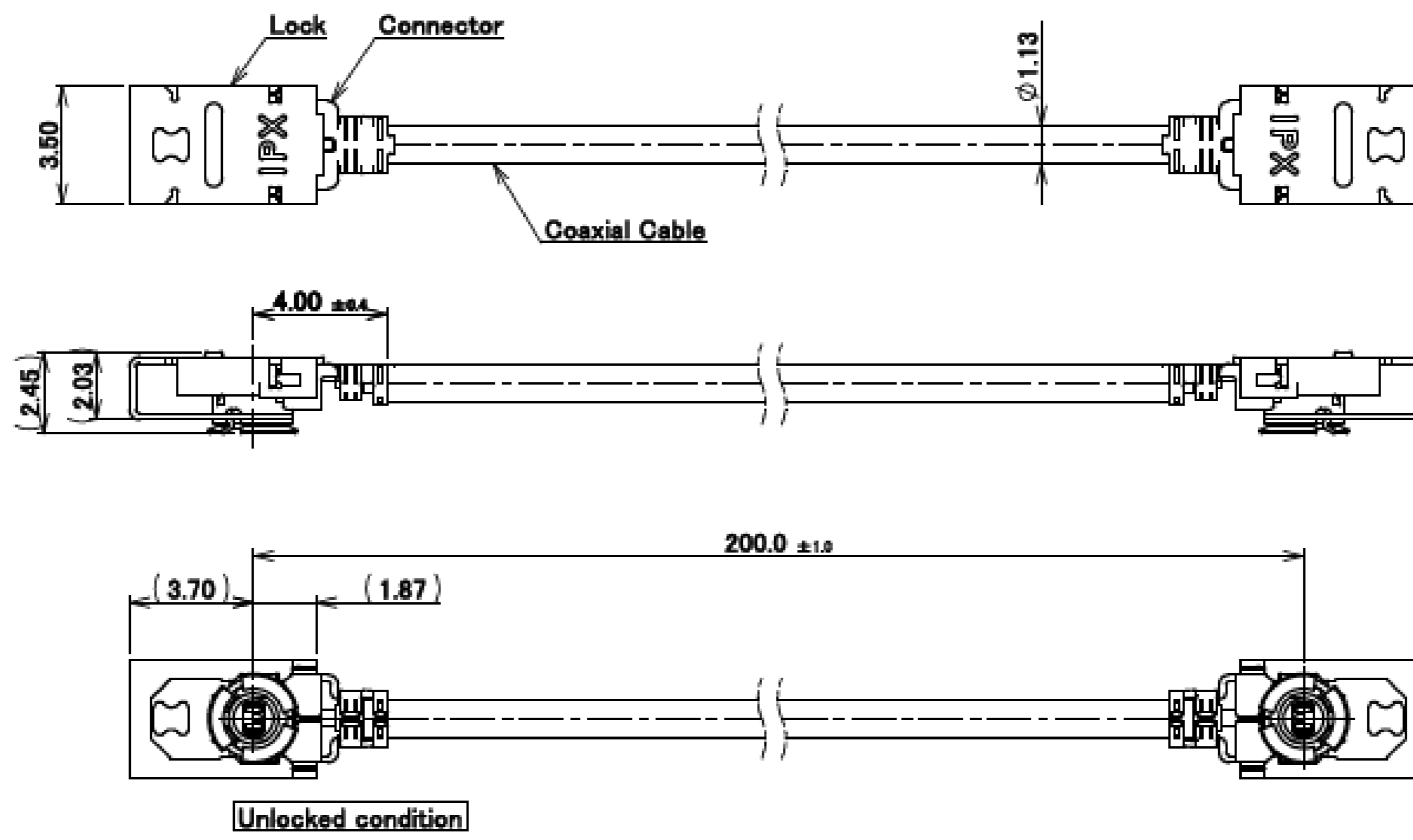

Rev.0

Cable : $\Phi 1.32$ mm

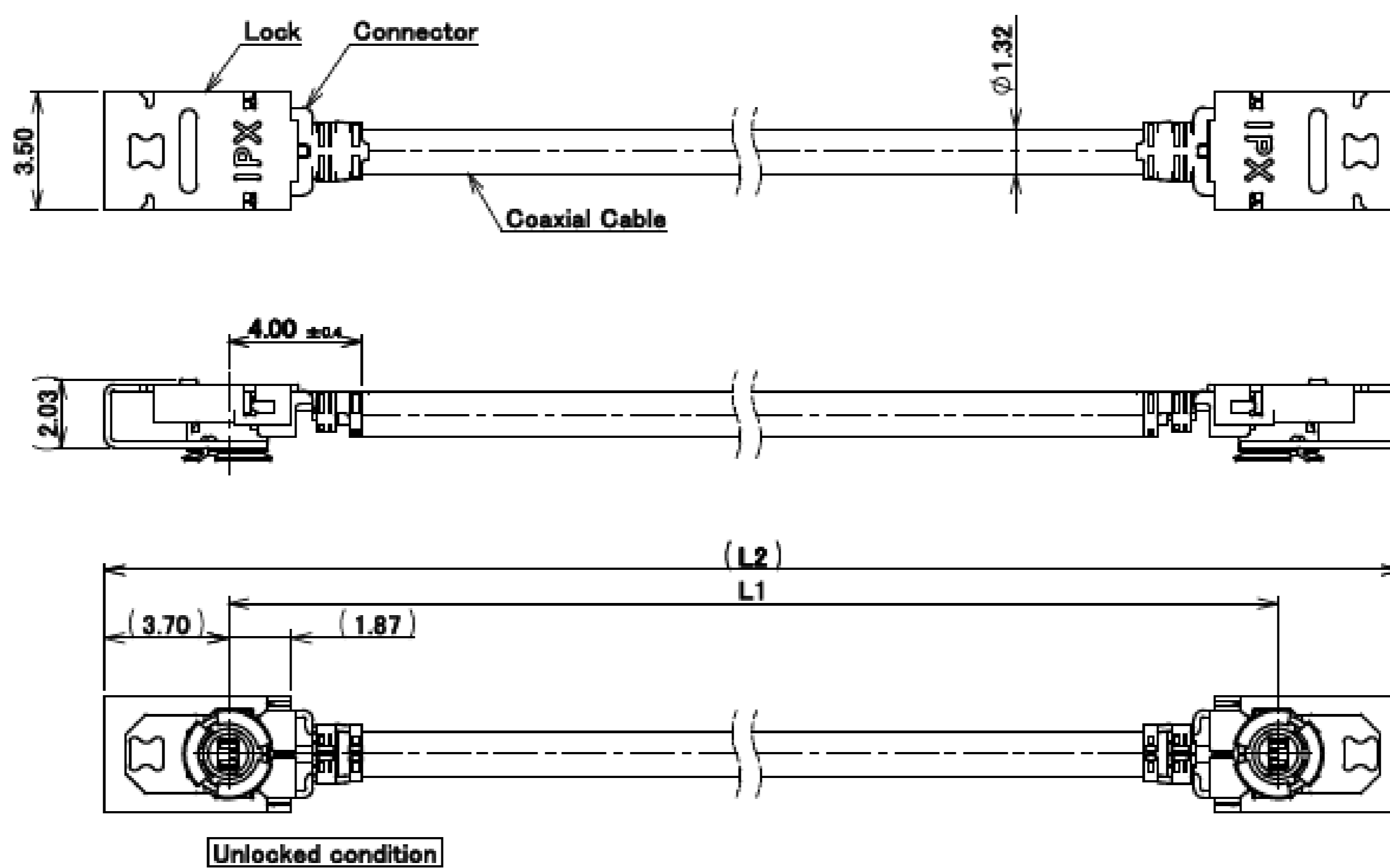

Rev.0

Cable : $\Phi 1.37$ mm

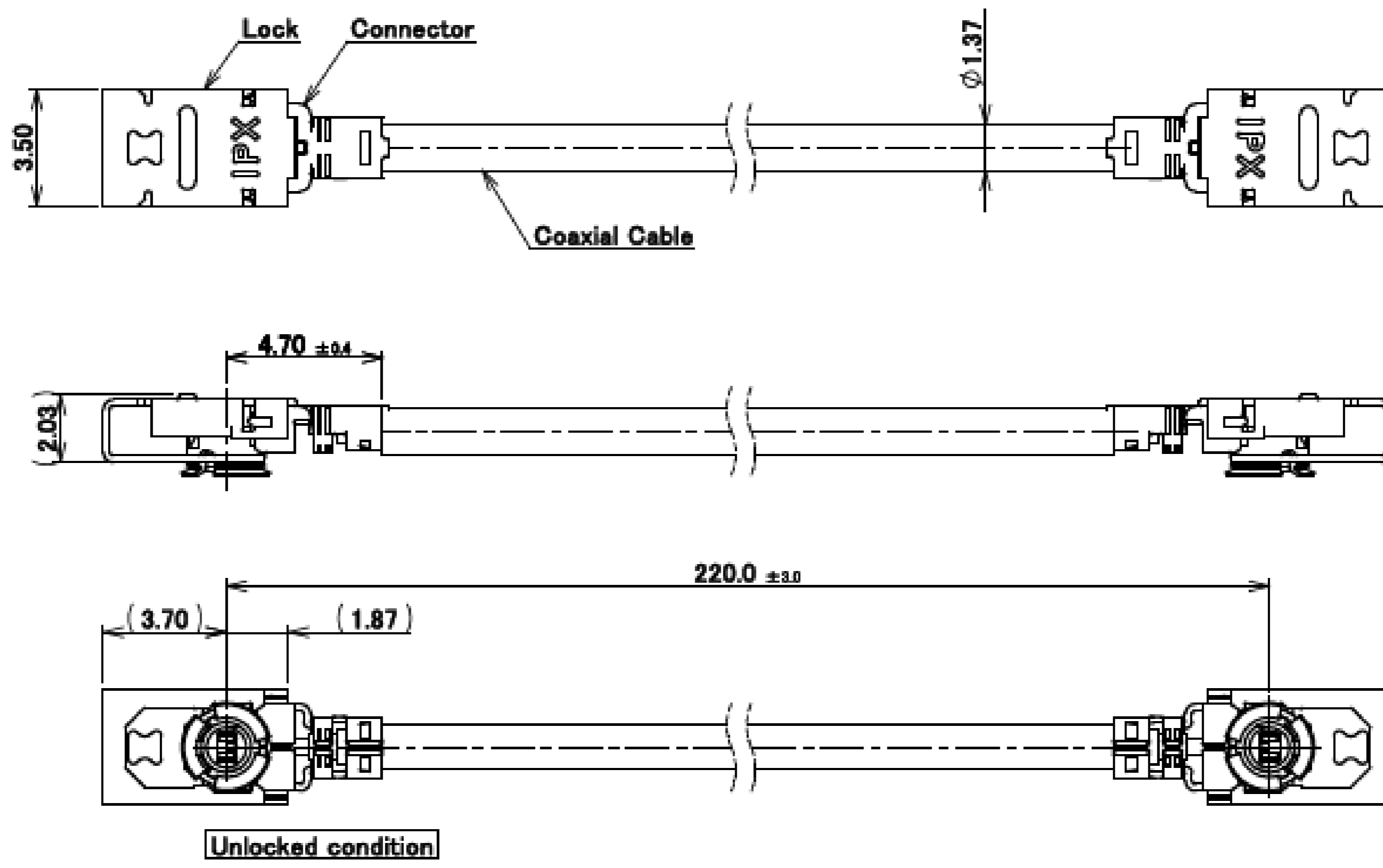

Rev.0

Cable : $\Phi 1.80$ mm

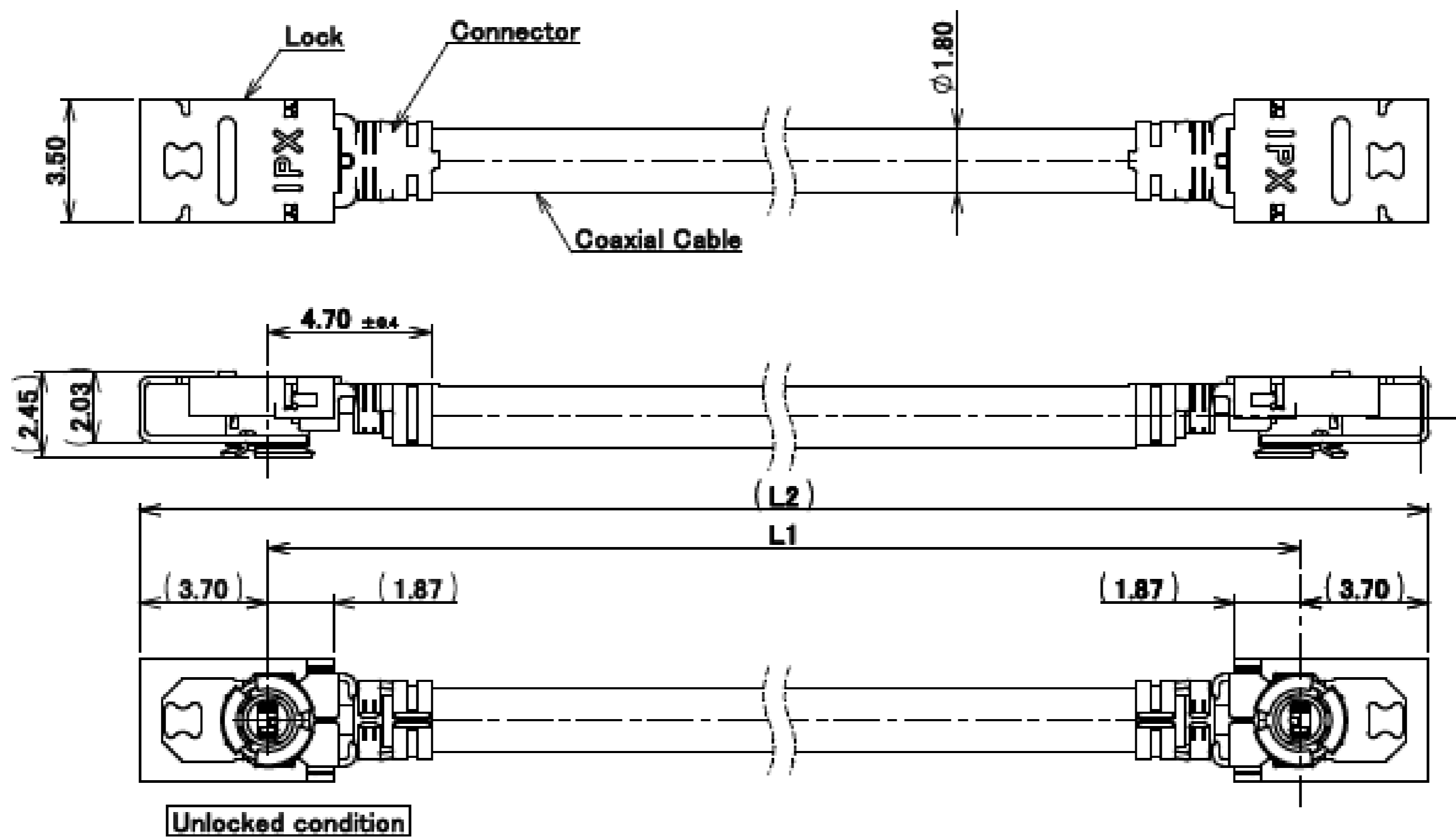

Rev.0

Custom Products Available

RF Connector

MHF® series



Micro-coaxial/Twinax/ Discrete Wire Connector

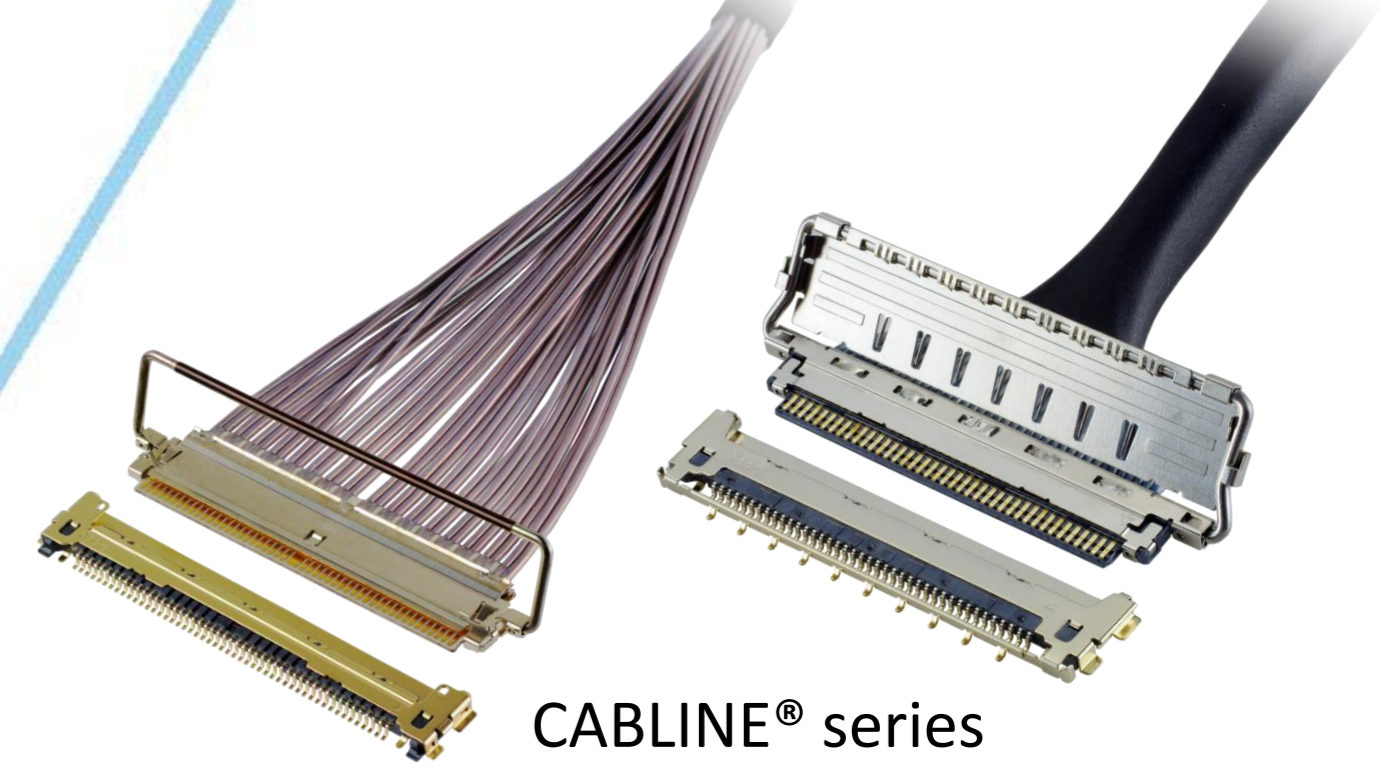

CABLINE® series



Optical Module

LIGHTPASS® series



NOVASTACK® series

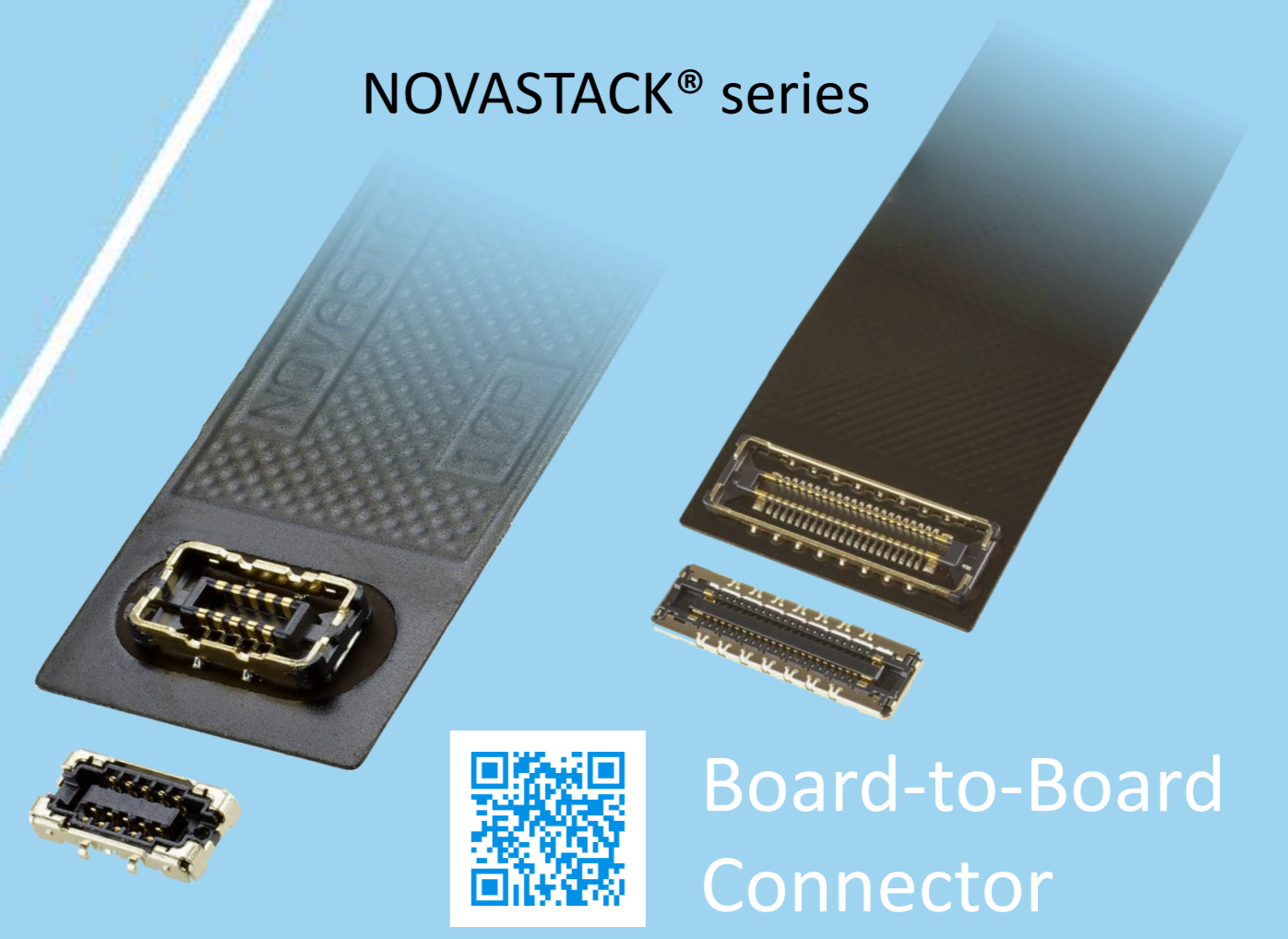

Board-to-Board Connector



Power Connector/ Terminal

AP series

ISH® series



MINIFLEX® series

EVAFLEX® series

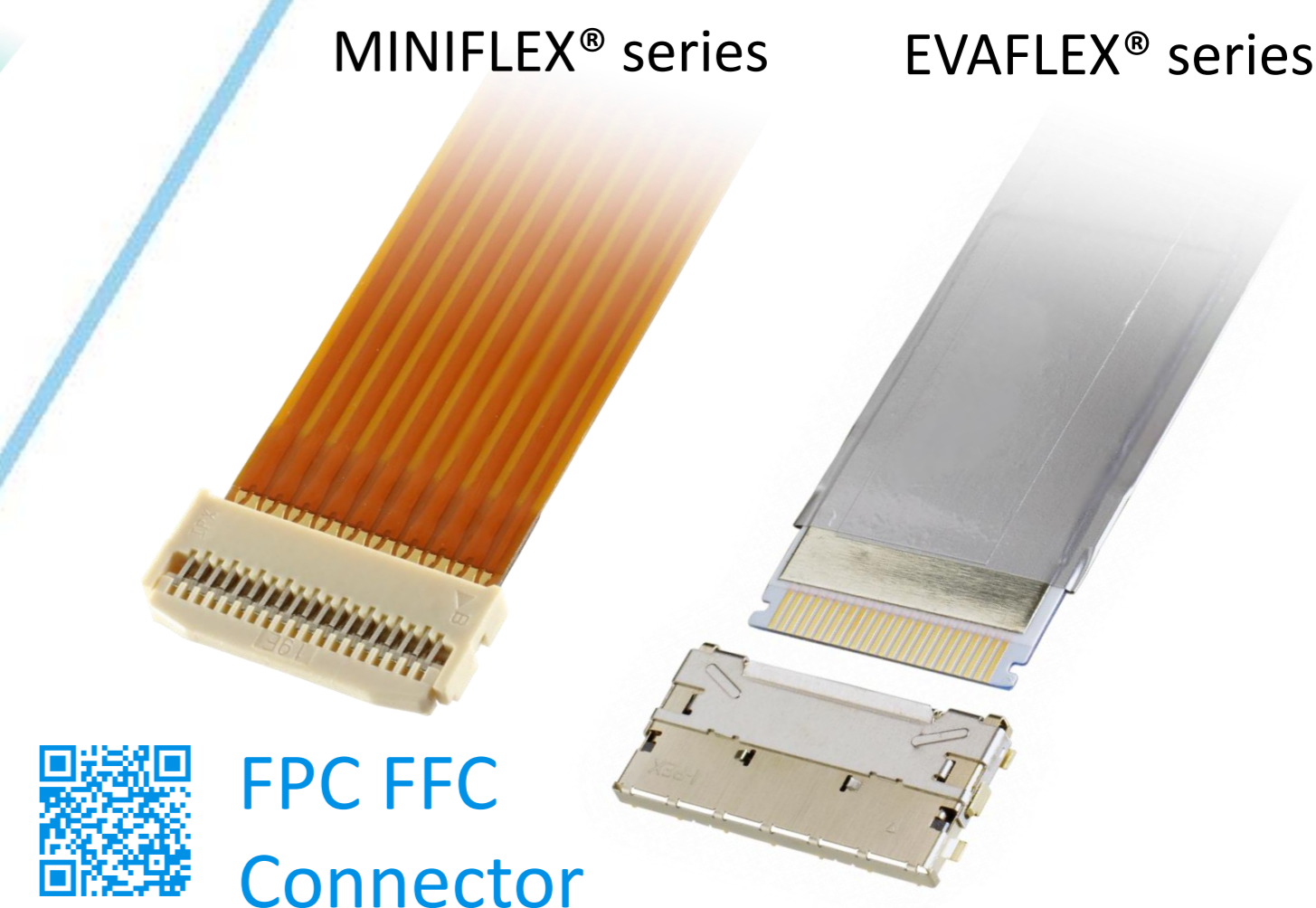

FPC FFC Connector



Inquiry



MINIDOCK® series

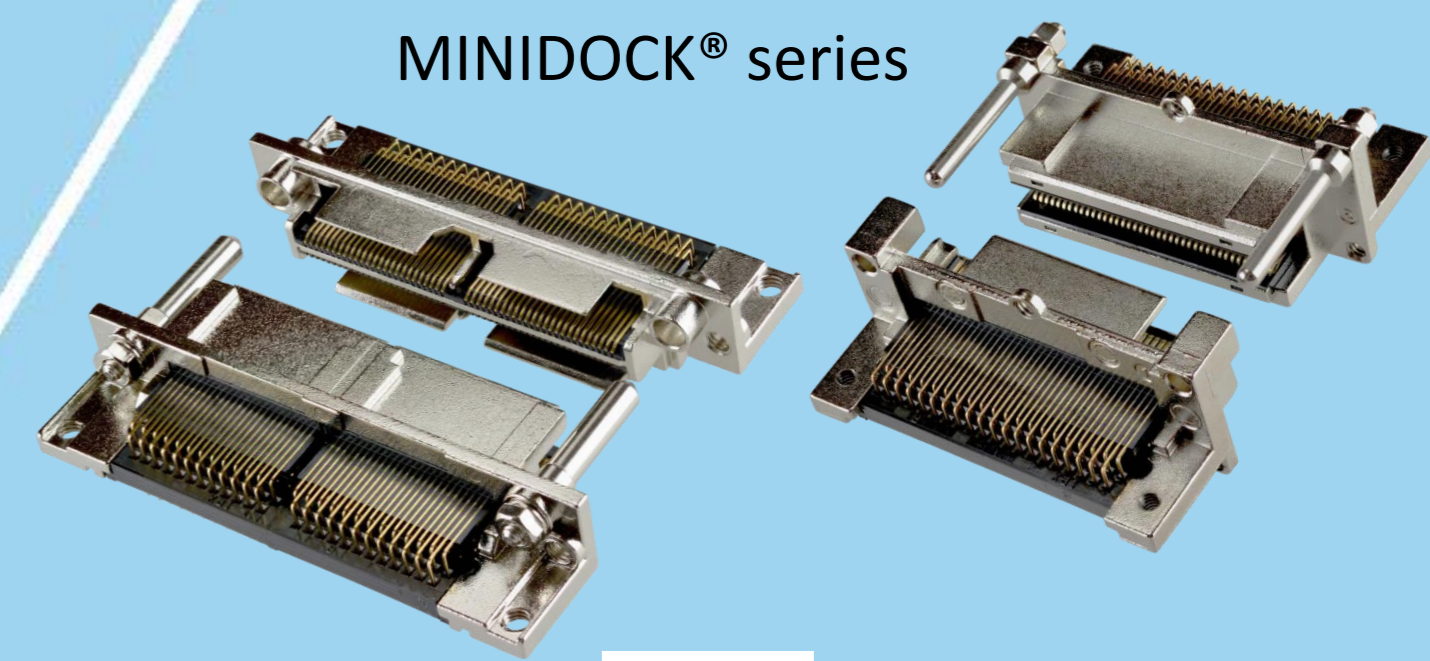

I/O Connector

I-PEX, MHF, CABLINE, LIGHTPASS, NOVASTACK, ISH, IARPB, MINIFLEX, EVAFLEX, MINIDOCKS and ZenShield are registered trademarks of I-PEX Inc. Please note that the contents in the catalog might be changed without prior notification. I-PEX Inc. assumes no responsibility for any inaccuracies or obligation to update information on these documents. Please be sure to read and understand the latest "Precautions for Use" and "Instruction Manual" before you use our products. We shall not be responsible for any defects, damages or troubles in case you use our products without following the precautions for use. Please feel free to contact our sales representatives when you use our products for any applications that require very high reliability and safety, or that relate to human life (ex. nuclear power control, aerospace, transportation, medical equipment, safety equipment etc.).

Contact your sales representative or more detailed information.

www.i-pex.com



I-PEX

© I-PEX Inc. 2024
All rights reserved